



## Feeding systems for handheld tools

**Efficient and intelligent feeding with eacy feed, the new generation vibratory bowl feeder.**

- **Approx. 80 % energy savings**
- **Efficiency and worldwide application - one design for all markets**

Our feeding systems consist of modules that are adapted to each other: one feeder with integrated controller, a handheld screwdriver or press-insertion devices and all other add-on components that fit the customer's application.

This proven system with an extreme high feed rate, allows a rational and process-optimized assembly.



## EACY FEED - THE VIBRATORY BOWL FEEDER FOR THE NEXT GENERATION

### e for efficiency

eacy feed – new generation vibratory bowl feeder with approx. 80 % reduction in power consumption due to efficient “low energy technology”!

Sustainable design!

### a for assembly

eacy feed – new generation vibratory bowl feeder with ergonomic handling by means of an optimised module.

User-friendly operation!

eacy

### c for communication

eacy feed – new generation vibratory bowl feeder with intelligent communication capabilities for application in a smart factory/ Industry 4.0 environment.

Intelligent automation!

### y for yield

eacy feed – new generation vibratory bowl feeder with optimised, technical efficiency due to robust design and tried and tested modular components.

Reliable assembly!

### Efficient and intelligent feeding

The innovative feeder eacy feed provides ideal specifications for the sustainable production of tomorrow: With its approx. 80 % power saving accomplishment the eacy feed is extremely energy efficient. For manual assembly applications, eacy feed offers flexible and efficient solutions along with top quality DEPRAG screwdrivers.

#### APPROX. 80 % ENERGY SAVINGS

- the revolutionary controller and the new drive allow for the extraordinary energy efficiency of eacy feed
- a significant reduction in power consumption is attained due to the 24 V oscillating magnets, thereby realising energy savings of around 80 %



#### USER FRIENDLY

eacy feed guarantees optimal assembly conditions with ergonomic and comfortable operation. The controller PFC100 enables customised settings without mechanical alterations.

- clear and easy operation via controller
- option of frequency and amplitude regulation via controller
- works to the individual working rhythm of the operator, with storage of up to 10 separate data sets

### Efficiency and worldwide application

We have developed an innovative feeder in eacy feed which is distinguished by its energy efficiency and countless application possibilities. The 24 V technology of the drive enables worldwide application. All you need is a universal power supply. Country specific variations are a thing of the past. Thanks to the 24 V technology, eacy feed ensures reliable running even in areas with poor network availability.

#### LOW CONSUMPTION AND TOP FLEXIBILITY

- revolutionary controller enables around 80 % less power consumption
- new controller and vibratory drive based on 24 V/DC voltage
- universal power unit (115 V – 230 V)
- independent from the local alternating current frequency
- one design for all markets

#### PERFECT VIBRATION INTENSITY

For monitoring and regulation of the vibration intensity an acceleration sensor is mounted on the vibratory drive.

- ensures stable output, independent from fill-level
- no need for readjustments
- supports ideal vibration behaviour and minimises material wear
- simplified reloading procedure
- accommodates all bowl sizes

**Efficient and intelligent feeding**

**eacy feed**

Vibratory bowl feeder for the next generation



- **Approx. 80 % energy savings**
- **Efficiency and worldwide application**

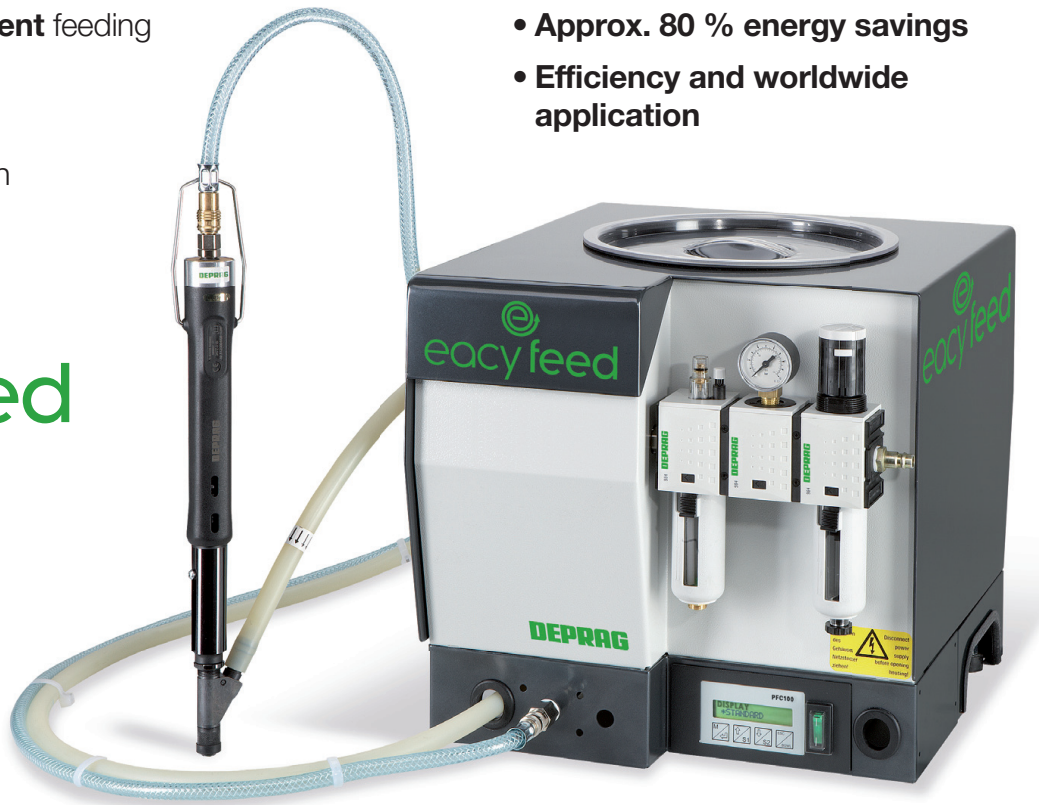

Controller PFC100

**SIMPLER FOR THE FITTER AND OPERATOR**

If several operators are using the same feeder at the same time, the efficiency of the process can often be compromised by the varying working speeds of each individual. DEPRAG feeders cleverly adapt to the individual working speeds of each operator. Once entered via the simple display, the specific operating parameters of each person are saved (storage of up to ten data sets) and can be recalled when there is a shift change. No one feels held back and no one feels overstretched.

**PRECISION AND TIMING**

The fill volume influences the feed rate in standard vibratory spiral feeders. If the feed bowl is full, the system works at a slower rate and if it is emptier the rate speeds up. As with the previous generation, the eacy feed is also fitted with a measurement transducer which records the oscillation amplitude in the feed bowl. This thereby adaptively regulates the feeder depending on the fill volume – ensuring reliability as the screws are continuously in readiness for processing.

The feed rate is adjustable using twelve different waveforms. The amplitude or frequency can be set in an instant. Individual settings can be used for example, to optimise the feed volume or reduce the noise level of the feeder. The adjustments can be carried out quickly and without mechanical intervention. When using eacy feed the required settings can simply be selected on the relevant controller.

## FEEDERS FOR HANDHELD TOOLS

### Vibratory bowl feeder

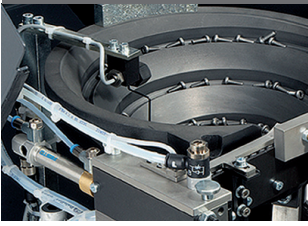

DEPRAG feeders with a vibratory drive are particularly suitable for screws from < M1 to M8.

Shaft lengths of 5 mm to 50 mm can be processed.

For counter-sunk head screws especially, vibratory bowl feeders are a functional solution. The high output of DEPRAG vibratory bowl feeders distinguishes them from other feeding systems.

#### Size:

0.15 l Feed volume

0.75 l Feed volume

1.20 l Feed volume

2.50 l Feed volume

Page 7

Page 7

Page 7

Page 7

### Sword feeder

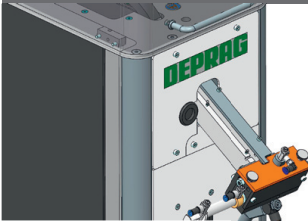

Sword feeders or segment feeders are used when components are particularly sensitive and a more gentle feeding environment is required. They are also extremely quiet. Our sword feeders can be used for screw sizes M2 to M6. They are ideal for screws up to 25 mm in length.

Balls with a diameter of 1 to 12 mm can also be fed.

#### Size:

0.15 l Feed volume

1.50 l Feed volume

Page 8

Page 8

### Pick-and-Place feeding system



If feeding via a hose system is not possible e.g. if the screw has a non favourable ratio in relation to the head diameter vs overall length, then we offer special solutions such as a pick-and-place procedure with vacuum pick or gripper pick devices.

#### Customised solution

Please contact our sales representatives.

### Screw presenter



Screw presenters are mainly used for applications where an automatic screwfeeding machine is not cost-effective due to low volume. A screw presenter can process screws with thread-sizes from M1 to M5 and a shaft-length of up to 25-mm. Even screws that cannot be fed through a feedhose, due to unfavorable dimensions, can be processed with a screw presenter.

→ Catalog D3840E

### Screwdrivers for the feeding system



Our feeders can be used in combination with almost any electric or pneumatic screwdriver of the MICROMAT/MINIMAT range. Additionally we also offer screwdrivers with ESD compliance.

Information

Page 11

### Press-insertion device for the feeding system



Our handheld press-insertion tools are combined with the suitable feeder. Our press-insertion systems are an adaptive solution for different applications.

Some of the connection-elements, such as rivets, pins, sleeves and balls can be processed with this system both process reliable and efficient.

Information

D3821E



# FEEDERS FOR HANDHELD TOOLS

## DEPRAG FEED MODULE

The DEPRAG Feed Module (DFM) enables screw assemblies on screw positions which are difficult to access (e.g. round housing forms), by using vacuum assistance.

Information and technical data

Page 9

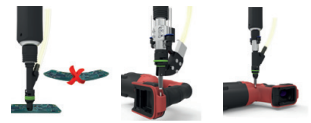

## CleanFeed Concept

The DEPRAG Concept for Technical Cleanliness - specifically designed components.

Information and technical data

Page 10

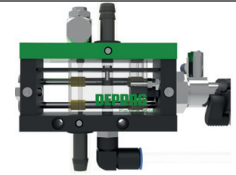

# STRUCTURE OF A DEPRAG FEEDING SYSTEM

DEPRAG feeding systems consist of the feed bowl unit, screw separator, an air connection and air maintenance unit, a mains power switch and electronic controller, 2 m standard length hose set, the mouthpiece guide and the mouthpiece as well as an appropriate screwdriver receiver (adapter) and a sound enclosure cover.

### With either vibratory bowl feeder or sword feeder

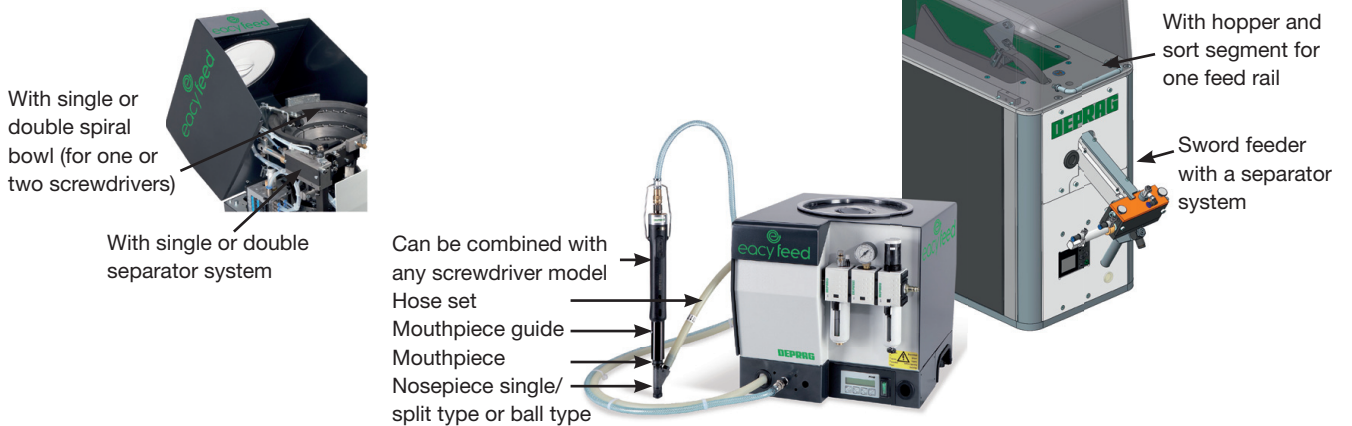

### If feeding with a hose system is not possible, we offer special solutions, such as the pick-and-place procedure

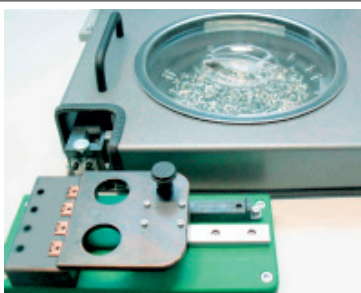

Defined pick position with integrated screw pick control option

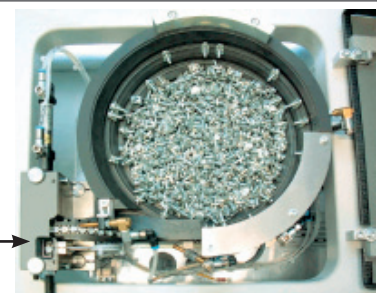

## GUIDELINE FOR THE SELECTION OF A SUITABLE FEEDER

### STEP 1: Feeding criteria

Basically all "shaft-heavy" screws with a head which fulfils the following criteria are suitable for processing with our feed systems:

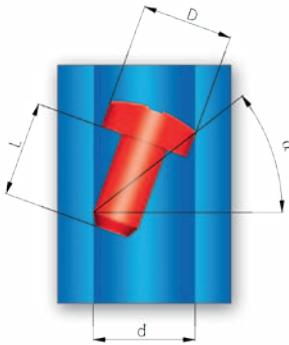

**Feeding criteria:**  
 $\alpha > 30^\circ$

$d \sim D + 0.5 \text{ mm}$

**Approximate formula:**

$L > D + 2 \text{ mm}$

$d$  = Internal diameter  
feed hose  
 $D$  = Screw head diameter  
 $L$  = Screw shaft length

### STEP 2: Screw quality

For reliable feeding machines a DIN quality standard (allowable 3% bad parts) is not always sufficient.

Higher levels of screw/fastener quality improve the feeder's reliability.

The goal should be a quality grade of 10 ppm ("parts per million"). I.e. in every 100,000 screws there can be 1 bad part.

### STEP 3: Which feeding principle is best suited to your application?

A vibratory spiral bowl is particularly suited to screws with awkward dimensions or those with special feed rate requirements.

The sword feeder is applied when extremely gentle handling of the parts is required or when very low noise level is a must.

If feeding with a hose system is not possible we also offer pick-and-place procedure.

### STEP 4: Determining the screw receiver

At the end of the mouthpiece there is a nosepiece ball type (1 or 2 rows) or a nosepiece split type, mounted to receive and position the screw.

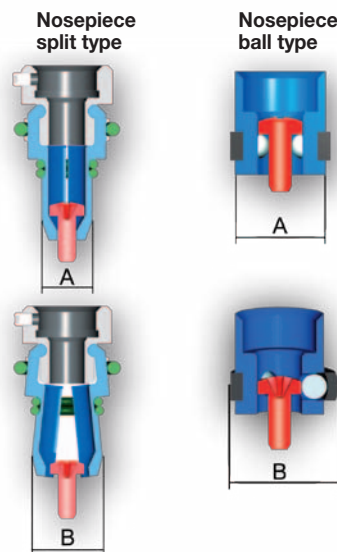

$D$  = Head diameter  
 $d$  = Shaft diameter  
 $n$  = Space required to open

$A = D + 2.5 \text{ mm}$   
 $B = A + D - d/2$

$B = 3D - 2d + 5 \text{ mm}$

$n = A \times B$

$n = \varnothing B$

### STEP 5: Space available on the component

For effective use of the handheld screw feeders the space available around the screw head on the assembled components is very important.

There is a certain space requirement for the nosepiece split type and ball type. An even surface simplifies the positioning and handling of the tool. Slanted surfaces with small diameter recessed screw-holes can only be accessed with templates which are available as optional equipment.

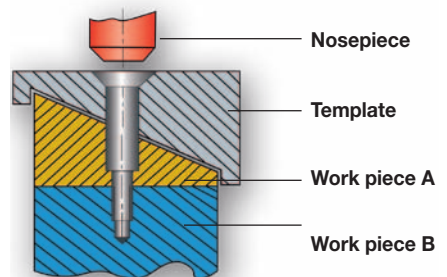

### STEP 6: Single or multiple feeding / screwdrivers?

Using a dual spiral vibratory bowl (type 1522 and 1622) one feeding machine can supply two separate screw outlet positions/screwdrivers. Compared to the investment of two single feeding machines, investment in a twin device saves approximately 25 %.

### STEP 7: Specification

For the correct specification of your screw feeding machine the following data is required:

- Voltage / frequency
- Choice of screwdriver model (torque and speed)
- Screw dimension and screw type (if available – DIN no.)
- Torque (if known)
- Details dimensions of assembly components
- Hose length (if over the standard length of 2 m).

To process your order we require sample screws (approx. 1 feed bowl volume) and if possible some samples of the part to be assembled.

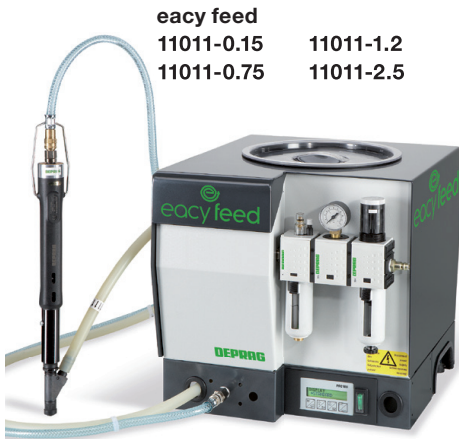

**eacy feed**  
**11011-0.15**      **11011-1.2**  
**11011-0.75**      **11011-2.5**



**Nuts**

**Screws**

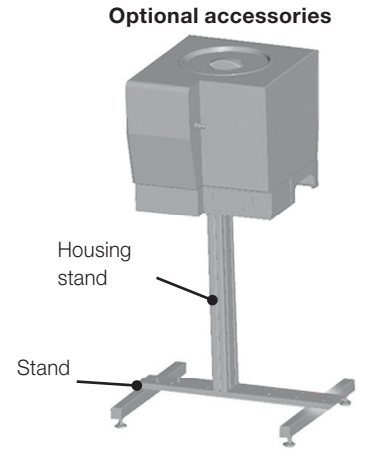

**Optional accessories**

Housing stand

Stand

Material to be fed		Screws or nuts						
								
Standard version	Type	11011-0.15	11022-0.15	11011-0.75	11022-0.75	11011-1.2	11011-2.5	11022-2.5
<b>Control unit</b>		<b>PFC100 Controller</b>						
<b>Transport Principle</b>		<b>Vibratory Bowl Feeders *)</b>						
Amount of connectable drivers		1	2	1	2	1	1	2
Feed rate	Parts/min	45	2 x 45	45	2 x 45	25	30	2 x 30
Filling capacity	liter/gal.	0.15 / 0.04	0.15 / 0.04	0.75 / 0.2	0.75 / 0.2	1.2 / 0.32	2.5 / 0.66	2.5 / 0.66
Voltage	V/Hz	24 Volt DC			24 Volt DC			
Power consumption	VA	max. 50		max. 50		max. 150		
Air pressure requirement	bar/PSI	6 / 85.2						
Air connection size	mm/in.	10 / <sup>3</sup> / <sub>8</sub>	10 / <sup>3</sup> / <sub>8</sub>	10 / <sup>3</sup> / <sub>8</sub>	10 / <sup>3</sup> / <sub>8</sub>	10 / <sup>3</sup> / <sub>8</sub>	10 / <sup>3</sup> / <sub>8</sub>	10 / <sup>3</sup> / <sub>8</sub>
Dimensions W x D x H	mm	296 x 360 x 289		360 x 414 x 368			547 x 600 x 294	
	in.	11 <sup>21</sup> / <sub>32</sub> x 14 <sup>3</sup> / <sub>16</sub> x 11 <sup>3</sup> / <sub>8</sub>		14 <sup>9</sup> / <sub>16</sub> x 16 <sup>5</sup> / <sub>16</sub> x 14 <sup>1</sup> / <sub>2</sub>			21 <sup>17</sup> / <sub>32</sub> x 23 <sup>5</sup> / <sub>8</sub> x 11 <sup>37</sup> / <sub>64</sub>	
Weight	kg/lbs	appr. 18/39.6	appr. 20/44	appr. 32/71	appr. 34/75	appr. 40/88	appr. 60/132	
Feedhose length standard	m/ft.	4 / 13.2	4 / 13.2	4 / 13.2	4 / 13.2	4 / 13.2	4 / 13.2	4 / 13.2
Feedhose length max.	m/ft.	8 / 26.4	8 / 26.4	8 / 26.4	8 / 26.4	8 / 26.4	8 / 26.4	8 / 26.4
<b>Technical details on screws:</b>								
Max. head diameter	mm/in.	5 / <sup>13</sup> / <sub>64</sub>	4 / <sup>5</sup> / <sub>32</sub>	12 / <sup>15</sup> / <sub>32</sub>	8 / <sup>5</sup> / <sub>16</sub>	12 / <sup>15</sup> / <sub>32</sub>	16 / <sup>5</sup> / <sub>8</sub>	14 / <sup>35</sup> / <sub>64</sub>
Max. shaft length	mm/in.	8 / <sup>5</sup> / <sub>16</sub>	8 / <sup>5</sup> / <sub>16</sub>	35 / <sup>1</sup> / <sub>8</sub>	25 / <sup>63</sup> / <sub>64</sub>	50 / <sup>1</sup> / <sub>32</sub>	60 / <sup>2</sup> / <sub>32</sub>	60 / <sup>2</sup> / <sub>32</sub>
Range of shaft diameter	mm/in.	1.2-2.5 / 0.048-0.1	1.2-2.5 / 0.048-0.1	1.5-7/0.06-0.27	1.5-7/0.06-0.27	3-7 / 0.12-0.28	4-8 / 0.16-0.31	4-8 / 0.16-0.31
<b>Technical details on nuts:</b>								
max. AF	mm/in.	4 / <sup>5</sup> / <sub>32</sub>	3 / 0.12	10 / <sup>3</sup> / <sub>8</sub>	8 / <sup>5</sup> / <sub>16</sub>	11 / 0.43	13 / 0.5	13 / 0.5
max. height	mm/in.	3 / 0.12	2 / 0.08	5 / <sup>13</sup> / <sub>64</sub>	4 / <sup>5</sup> / <sub>32</sub>	6 / 0.23	8 / <sup>5</sup> / <sub>16</sub>	8 / <sup>5</sup> / <sub>16</sub>
<b>Included in delivery:</b>		Power unit 105535A		Power unit 105535A		Power unit 2041061		
<b>Required accessories:</b>		Power cable 812587 (EU) or Power cable 812295 (US)		Power cable 812587 (EU) or Power cable 812295 (US)		Power cable 812587 (EU) or Power cable 812295 (US)		
<b>Optional accessories:</b>								
Housing stand		102483A		3641392A	3641392A		345680A	
Stand (required for housing stand)		994449		994449	994449		999309	
Fill level indicator		414965J		414965A	414965A		414965D	
Retaining plate		9198574		9198574	9198573		-	
<b>More optional accessories:</b>		Hopper (see brochure D3850E) Special mouthpiece for critical screw head diameter to length relation Part template for positioning						

\*) with plastic vibratory bowl



At DEPRAG, we are committed to constantly improving our software solutions. To harness these benefits, we recommend regularly updating to the latest edition. For more information, please contact our service department at [service@deprag.de](mailto:service@deprag.de).



A connecting cable is required to connect external controller with feeder. Part number will be assigned in case of an order.  
 Every feeding system contains all required attachments for the screwdriver such as mouthpiece guide, mouthpiece, locking sleeve and bits. Various specialised versions are available depending on application and the screwdriver in use.

## TECHNICAL DATA SWORD FEEDER



11811-1.5



Screws

Optional accessories

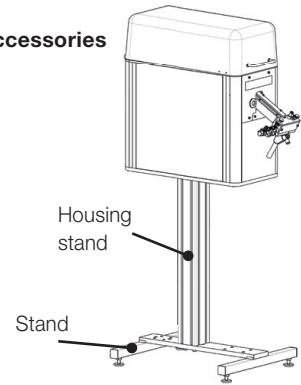

Housing stand

Stand

Material to be fed		Screws	
<b>Sword Feeder with integrated controller</b>	<b>Type</b>	<b>1811-0.15-x*) Controller 6</b>	<b>11811-1.5 PFC18L Controller (insulation IP30)</b>
Amount of connectable drivers		1	1
Feed rate	Parts/min	30	30
Filling capacity	liter/gal.	0.15 / 0.04	1.5 / 0.4
Voltage	V/Hz	230/50, 115/60	24 Volt DC
Power consumption	VA	20	50
Air pressure requirement	bar/PSI	6.3 / 90	6 / 85.2
Air connection size	mm/in.	10 / <sup>3</sup> / <sub>8</sub>	10 / <sup>3</sup> / <sub>8</sub>
Dimensions W x D x H	mm	320 x 255 x 260	267 x 704 x 550
	in.	12 <sup>19</sup> / <sub>32</sub> x 10 <sup>3</sup> / <sub>64</sub> x 10 <sup>15</sup> / <sub>64</sub>	10 <sup>33</sup> / <sub>64</sub> x 27 <sup>23</sup> / <sub>32</sub> x 21 <sup>21</sup> / <sub>32</sub>
Weight	kg/lbs	12 / 26.4	approx. 30 / 66
Feedhose length standard	m/ft.	2 / 6.6	2 / 6.6
Feedhose length max	m/ft.	5 / 16.4	8 / 26.24
<b>Technical details on screws:</b>			
Max. head diameter	mm/in.	5 / <sup>13</sup> / <sub>64</sub>	12 / <sup>15</sup> / <sub>32</sub>
Max. shaft length	mm/in.	8 / <sup>9</sup> / <sub>16</sub>	25 <sup>63</sup> / <sub>64</sub>
Range of shaft diameter	mm/in.	1-2.5 / 0.04-0.1	2 - 6.3 / 0.08 - 0.25
<b>Included in delivery:</b>		-	Power unit 105535A
<b>Required accessories:</b>		-	Power cable 812587(EU) or power cable 812295(US)
*) x = Voltage Supply (1: 230 V / 50 Hz, 2: 115 V / 60 Hz)			
<b>Optional accessories:</b>		Hopper (see brochure D3850E)	
Additional function controls		screw presence control, inlet control, fill level height	-
Housing stand	Part no.	-	3641393A
Stand (required for housing stand)	Part no.	-	994449
Retaining plate	Part no.	-	9198574



A connecting cable is required to connect external controller with feeder. Part number will be assigned in case of an order.

Every feeding system contains all required attachments for the screwdriver such as mouthpiece guide, mouthpiece, locking sleeve and bits. Various specialised versions are available depending on application and the screwdriver in use.

## SPECIAL SOLUTIONS

Please contact our sales representatives if you cannot find a screwdriving technique suitable to your application in this description of our standard solutions.

As well as our standard solutions de-scribed in this brochure we also offer customer specific and application specific solutions.



**Advantages:**

- easy to operate
- applies constant pressure
- for hand guided nut assembly
- allows upgrade option for existing manual work-stations
- effortless bit exchange
- cycle time optimized

The DEPRAG Feed Module (DFM) enables screw assemblies on screw positions which are difficult to access (e.g. round housing forms), by using vacuum assistance.

Screws or nuts can be positioned mechanically and set-in-place by using vacuum suction. The operator can therefore access even hard-to-reach screw positions with-out any problems. Independent from the operator, the integrated stroke-mechanics uses cylinders to control the precise pressure required for the positioning element.

**The best solution**

- for recessed screw positions
- for nut assemblies
- for pressure control (prevent damage to parts)

Optionally available: rotating hand grip for components which require differing jaw-openings of the nosepiece.

LED status display (red/green) on the hand grip: Direct status feedback in the operator's line of sight.

Clamping cartridge for all DEPRAG stands and portals ensures ease of operation without annoying pressure reaction force.

**Programmable pressure control**

For screwdriving tasks with differing pressure requirements during a single assembly task.

The DEPRAG Feed Module can be combined with an EC-Servo-, EC- or pneumatic screwdriver with mechanical shut-off clutch, a DEPRAG feeding system, linear stand, position control stand, linear portal and position control gantry.



**Technical data**

<b>Version 1</b>	1 stroke, screw assembly via nosepiece, stroke 60 mm, max. vertical pressure 120 N
<b>Version 2</b>	2 strokes, vacuum-supported screw/nut assembly, stroke 60 mm, max. vertical pressure 120 N
<b>Options:</b>	Stroke extension 20 mm or 40 mm per version
	DFM with pressure control
	Fixed intermediate piece with LED display and additional button for program selection
	Rotatable intermediate piece with LED display and additional button for program selection (the rotatable joint enables nosepieces to be adjusted according to component geometry)



for pressure control



for nut assemblies



for recessed screw positions

# CLEAN FEED - THE DEPRAG CONCEPT FOR TECHNICAL CLEANLINESS

**AVOID ABRASION**



Low abrasion, component friendly feeding of connection elements with a DEPRAG sword feeder.

Dirt particles can cause damage to products or product related systems. Therefore: avoid abrasion, reduce abrasion or target and remove abrasion! These are the essential requirements for screw assembly in cleanrooms to ensure a high quality result for the assembled components. The DEPRAG CleanFeed concept provides an all-encompassing solution.

**Your Advantage:**

Integrated concept for Technical Cleanliness!  
The complete program of all required components from a single source.

**Function:**

The component is stopped at position 1 and particulates on the auto fed part (e.g. screw) are extracted via vacuum. The particulates are collected by an exchangeable filter element (which is visible through a viewing pane). In position 2 the cleaned component is presented either to the auto assembly module tooling (Inline Variant) or to a pick position (Pick&Place Variant).

**REDUCE ABRASION**

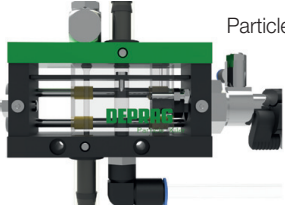

Particle Killer

Application of the following equipment can help to produce the optimal results:

- Pre-cleaned assembly components (e.g. Arnold Cleancon® screws) - fewer particulates due to an additional cleaning process
- DEPRAG HSF Sword Feeder - vibration free part feeding and therefore less particle generation
- DEPRAG Particle Killer - debris in the autofeed process is reduced selectively
- DEPRAG SFM-V vacuum screwdriving module - debris created during the assembly process is extracted usin vacuum sources

**REMOVE ABRASION**

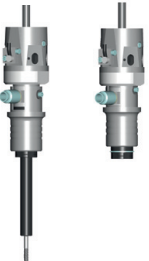

Vacuum suction

**Technical data**

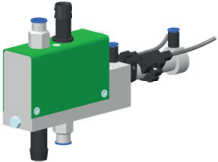
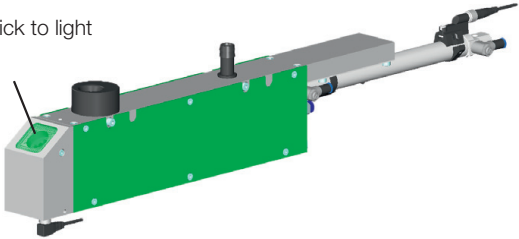
	<b>Inline Variant</b>	<b>Pick&amp;Place Variant</b>
Required control components	Pneumatic Valve/Vacuum Generator	Pneumatic Valve/Vacuum Generator
Connections	24VDC PNP	24VDC PNP
Dimensions (LxWxH) mm	170 x 30 x 120 (without hoses)	540 (due to 160 mm load stroke) x 50 x 125 (without hoses)
		Pick to light 

**MINIMAT-EC-SERVO-SCREWDRIVER with highest processing control**

electronically controlled screwdriver with brushless direct-current motor and integrated sensor technology for torque and angle; cabled power supply - the stationary screwdriver in combination with components (e.g. handle) is suitable for the manual use

→ brochure D3161E

**MINIMAT-EC-SREWDRIVER with processing control**

electronically controlled screwdriver with brushless direct-current motor, torque measurement based on a highly accurate measurement of the motor current; cabled power supply

→ brochure D3490E

**ELECTRIC SCREWDRIVER with mechanical shut-off clutch**

drive with brushless direct-current motor, shut-off via mechanical shut-off clutch

→ brochure D3480E

**MICROMAT-Z/MINIMAT-Z - PNEUMATIC SCREWDRIVER**

shut-off via highly accurate mechanical shut-off clutch

→ brochure D3420E and D3430E

**ERGOMAT-Z -the pneumatic AUTO STROKE SCREWDRIVER**

→ page 11

**MICROMAT-FZ/MINIMAT-FZ - PNEUMATIC SCREWDRIVER WITH MULTI FUNCTION CONTROL**

handheld screwdrivers in connection with a function controller and the pneumatic control; a complete solution for the process reliability of manual assemblies.

→ brochure D3440E

**SENSOMAT-Z - PNEUMATIC HANDHELD SCREWDRIVER with a mechanical clutch-function**

→ brochure D3460E

**ERGOMAT-Z – THE AUTO STROKE SCREWDRIVER FOR FEEDERS**

When using feeders with hand-screwdrivers, it is necessary for the bit to retract, so that a new screw can fall into the feed-channel.

With the ERGOMAT-Z driver, this stroke is performed automatically within the driver.

The two components, clutch bearing and mouthpiece guide, are already integrated in the screwdriver housing. The stroke of the driver is activated by the feeder immediately after the screw is fed. The driver with the bit is positioned immediately above the screw head. When the screwdriver starts the screw cannot be pushed back into the mouth-piece. Because of the integrated stroke, the hand can guide the driver much closer to the screw hole.

Both features simplify the positioning process and ease handling.

Additionally, the ERGOMAT-Z driver has all the advantages of the MINIMAT screwdriver series.

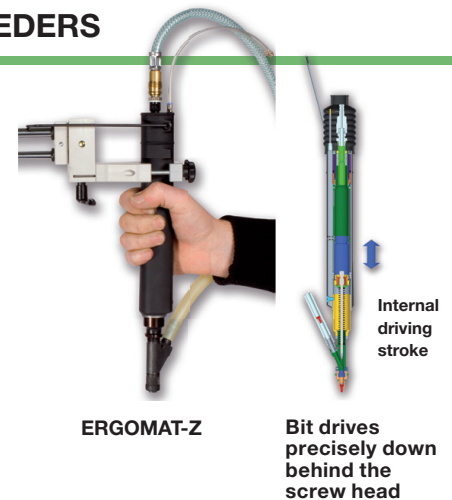

**Technical data ERGOMAT-Z**

Screwdriver model		Motor Size 1			
Screwdriver right rotation, right shut-off	Type	347V-218	347V-318	347V-518	347V-718
Push-to-start	Part no.	406859A	406859B	406859C	406859G
Torque min.	Nm/in.lbs	0.3 / 2.7	0.3 / 2.7	0.2 / 1.8	0.2 / 1.8
Torque max.	Nm/in.lbs	1 / 8.85	1.4 / 12.4	2 / 17.7	2.5 / 22.1
Speed, idling	rpm	1900	1300	900	640
Air consumption	m <sup>3</sup> /min/cfm	0.23 / 8	0.23 / 8	0.23 / 8	0.23 / 8
Main body dia.	mm/in.	32/38 – 1 1/4 / 1 1/2	32/38 – 1 1/4 / 1 1/2	32/38 – 1 1/4 / 1 1/2	32/38 – 1 1/4 / 1 1/2
Length	mm/in.	250 / 9 <sup>27</sup> /32	250 / 9 <sup>27</sup> /32	250 / 9 <sup>27</sup> /32	250 / 9 <sup>27</sup> /32
Weight	kg/lbs	0.8 / 1.8	0.8 / 1.8	0.8 / 1.8	0.8 / 1.8
Noise level	dB(A)	63	63	63	66
Air hose dia.	mm/in.	6 / 1/4	6 / 1/4	6 / 1/4	6 / 1/4
Drive hex. female DIN ISO 1173		1/4"	1/4"	1/4"	1/4"
Quick change chuck, mounted		yes	yes	yes	yes
For screwfeeding: Max. head diameter	mm/in.	8 / 5/16	8 / 5/16	8 / 5/16	8 / 5/16

Performance data relate to an air pressure of 6.3 bar (90 PSI)

**Included in delivery:**

Set of coupler and connector plug · Set of torque adjustment tools · Set of clutch springs

**Optional Equipment:**

Clamping flange with pistol grip part no. 405545A (for conversion to use as pistol grip screwdriver)

# DEPRAG

**DEPRAG SCHULZ GMBH u. CO.**

P.O. Box 1352, D-92203 Amberg, Germany  
Carl-Schulz-Platz 1, D-92224 Amberg  
Phone (+49) 9621 371-0, Fax (+49) 9621 371-120  
[www.deprag.com](http://www.deprag.com)  
[info@deprag.de](mailto:info@deprag.de)

CERTIFIED AS PER DIN EN ISO 9001

---