







Our standard colours

All our products have an environmentally friendly powder coating.
Standard colours are only the textured and matt colours listed below. Other textures and finishes are available at extra cost.
Licensed colours of well-known brands are not available due to reasons of reutrality.



 RAL 1023 traffic yellow	 RAL 5002 ultramarine blue	 RAL 7016 anthracite grey
 RAL 3000 - Fire Red	 RAL 5005 signal blue	 RAL 7035 light grey
 RAL 3003 ruby red	 RAL 5010 gentian blue	 RAL 7040 window grey
 RAL 3020 traffic red	 RAL 5012 light blue	 RAL 9005 jet black
	 RAL 5013 cobalt blue	 RAL 9006 - White aluminium
	 RAL 6011 reseda green	 RAL 9010 pure white
	 RAL 6018 yellow green	

Workplace system features

workraster - the structured one

The **workraster** is the "entry-level model" among our ergonomic workplace systems. Thanks to a structured grid arrangement of 38 mm, the worktable can be individually set to your required height and is therefore suitable for both sitting and standing activities. With a load capacity of 300 kg with an even load, it is ideal for the assembly of small to medium-sized parts.



workergo - the versatile one

The **workergo** is the most versatile workplace system. Six different frame widths, three different frame depths and four different types of height adjustment make the workergo C-foot and 4-foot a versatile worktable.



New
Now faster and more quiet!

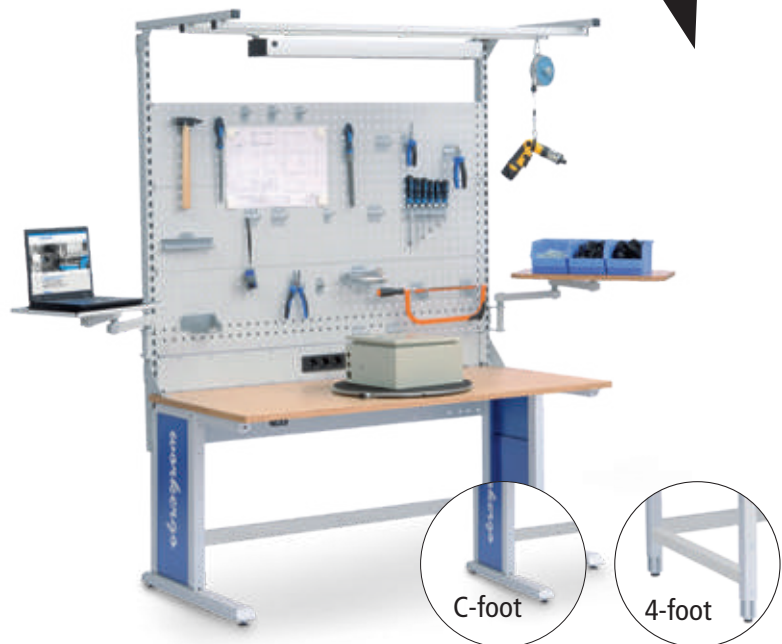

Our features at a glance	
Modular system	Base modules are connected to each other by means of cross-members - add-on modules are not required
Can be retrofitted	Extension of existing workstations, inline and corner combinations possible
Frame widths	1000, 1500 mm
Frame depths	500, 800, 960, 1460 mm
Frame heights	1348, 2070 mm
Work height without worktop	715 – 1057 mm with reinforcement rod Recommended: 829 mm
Height adjustment	Height grid arrangement of 38 mm
Frame design	L-foot
Load capacity	300 kg with even load

Our features at a glance	
Modular system	Freely selectable combinations from frame to worktop
Can be retrofitted	Multi-board setup and optional accessories
Frame widths	750, 1000, 1250, 1500, 1750, 2000 mm
Frame depths	600, 750, 900 mm
Travel speed	12 mm/s
Work height without worktop	670-1015 mm Travel: 345 mm
Height adjustment	Four different types: Clamp fixing, crank adjustment, electric height adjustment with 1 motor, electric height adjustment with 2 motors
Frame design	C-foot and 4-foot
Load capacity	180-300 kg with uniform load depending on height adjustment

▶ You can find further information on workraster on page 316

▶ You can find further information on workergo on page 334

workline - the highest one

The **workline** worktable achieves a working height of 1100 mm thanks to its continuous height adjustment and is therefore also an optimal standing workplace. At the same time, its simple and functional design ensures an ergonomic seated workplace.



powerline - the strongest ones

Thanks to its electric height adjustment, the **powerline** quietly moves to the required working height in a range of 705-1155 mm with a vertical travel speed of 9 mm/s without load. Thus, the powerline creates a flexible seated/standing workplace without long waiting times. At the same time, the quiet worktable has an extremely high load capacity.

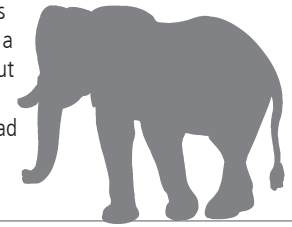











Our features at a glance	
Modular system	Individual workstations can be quickly expanded to group workstations
Can be retrofitted	Wide range of accessories: Flexible design and conversion of the workplace
Frame widths	1000, 1500 mm
Frame depths	750 mm
Travel speed	6.25 mm/s
Work height without worktop	735-1100 mm Travel: 365 mm
Height adjustment	Three different types: Clamp fixing, crank adjustment, electric height adjustment
Frame design	A-foot
Load capacity	180-200 kg with uniform load depending on height adjustment

Features at a glance	
Can be retrofitted	Multi-board setup or stand and optional accessories such as foot switch
Frame widths	1250, 1500, 2000 mm
Frame depth	750, 900 mm
Travel speed	9 mm/s without load
Work height without worktop	705-1155 mm Travel: 450 mm
Height adjustment	Electric height adjustment
Frame design	C-foot and 4-foot
Load capacity	600-900 kg with uniform load depending on frame design

▶ You can find further information on workline on page 356

▶ You can find further heavy load tables on page 380

Grid subdivision

	Series workline	Series maxmobile 1	Series maxmobile 2	Series T500	Series T500
					
	Housing W x D 365 x 400	Housing W x D 630 x 390	Housing W x D 630 x 490	Housing W x D 380 x 500	Housing W x D 530 x 500
Housing height	Usable heights	Usable heights	Usable heights	Usable heights	Usable heights
208	–	–	–	–	–
215	–	–	–	150	–
358	–	–	–	–	–
365	–	–	–	300*	300*
465	–	–	–	400*	400*
469	–	–	–	–	350
500	400	–	–	–	–
519	–	–	–	–	400
619	–	–	–	–	500
719	–	600	600	–	600
819	–	–	–	–	700
919	–	–	–	–	800
1019	–	–	–	–	900
1119	–	–	–	–	1000
1219	–	–	–	–	1100
1319	–	–	–	–	1200
1419	–	–	–	–	1300
1519	–	–	–	–	1400
					
	Drawer W x D 300 x 350	Drawer W x D 600 x 300	Drawer W x D 600 x 400	Drawer W x D 300 x 400	Drawer W x D 450 x 400
Front height	Load capacity	Load capacity	Load capacity	Load capacity	Load capacity
50	–	35 kg	35 kg	–	–
75	–	35 kg	35 kg	50 kg	50 kg
100	20 kg	35 kg	35 kg	50 / 75 kg	50 / 75 kg
125	–	–	–	–	–
150	–	35 kg	35 kg	50 / 75 kg	50 / 75 kg
175	–	–	–	–	–
200	20 kg	35 kg	35 kg	50 / 75 kg	50 / 75 kg
250	–	–	–	50 / 75 kg	50 / 75 kg
300	–	–	–	50 / 75 kg	50 / 75 kg
400	20 kg	–	–	–	–
	Series workline	Series maxmobile 1	Series maxmobile 2	Series T500	Series T500
	T370 12-14	T390 24-12	T490 24-16	T500 12-16	T500 18-16
Grid:	R 12-14	R 24-12	R 24-16	R 12-16	R 18-16

All dimensions in mm

New heights

Serie	Serie	Serie	Serie	Serie	Serie
T500	T500	T736	T736	T736	T736

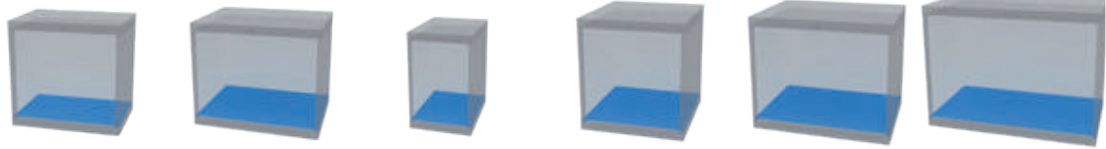

	Housing B x T	Housing B x T	Housing B x T	Housing B x T	Housing B x T	Housing B x T
	680 x 500	980 x 500	555 x 736	705 x 736	1005 x 736	1305 x 736
Housing height	Usable heights	Usable heights	Usable heights	Usable heights	Usable heights	Usable heights
208	–	–	150*	–	–	–
215	–	–	150*	–	–	–
358	–	–	300*	300	–	–
365	–	–	300*	–	–	–
465	–	–	400*	–	–	–
469	–	–	–	–	–	–
500	–	–	–	–	–	–
519	400	–	400	400	400	–
619	500	500	500	500	500	–
719	600	600	600	600	600	–
819	700	700	700	700	700	700
919	800	800	800	800	800	800
1019	900	900	900	900	900	900
1219	1000	1000	1000	1000	1000	1000
1119	1100	1100	1100	1100	1100	1100
1319	1200	1200	1200	1200	1200	1200
1419	1300	1300	1300	1300	1300	1300
1519	1400	1400	1400	1400	1400	1400



	Drawer W x D	Drawer W x D	Drawer W x D	Drawer W x D	Drawer W x D	Drawer W x D
	600 x 400	900 x 400	450 x 600	600 x 600	900 x 600	1200 x 600
Front height	Load capacity	Load capacity	Load capacity	Load capacity	Load capacity	Load capacity
50	–	–	70 kg	70 kg	70 kg	–
75	50 kg	50 kg	100 kg	100 kg	100 kg	100 kg
100	50 / 75 kg	50 / 75 kg	100 / 180 kg	100 / 180 kg	100 / 180 kg	180 kg
125	–	–	100 / 180 kg	100 / 180 kg	100 / 180 kg	180 kg
150	50 / 75 kg	50 / 75 kg	100 / 180 kg	100 / 180 kg	100 / 180 kg	180 kg
175	–	–	100 / 180 kg	100 / 180 kg	100 / 180 kg	180 kg
200	50 / 75 kg	50 / 75 kg	100 / 180 / 300 kg	100 / 180 / 300 kg	100 / 180 / 300 kg	180 kg
250	50 / 75 kg	50 / 75 kg	100 / 180 / 300 kg	100 / 180 / 300 kg	100 / 180 / 300 kg	180 kg
300	50 / 75 kg	50 / 75 kg	100 / 180 / 300 kg	100 / 180 / 300 kg	100 / 180 / 300 kg	–
400	–	–	100 / 180 kg	100 / 180 kg	100 / 180 kg	–

Serie	Serie	Serie	Serie	Serie	Serie	
T500	T500	T736	T736	T736	T736	
T500 24-16	T500 36-16	T736 18-24	T736 24-24	T736 36-24	T736 48-24	
Grid:	R 24-16	R 36-16	R 18-24	R 24-24	R 36-24	R 48-24

* Hanging drawer block, bottom open

Contents



Drawer cabinets



Page 40

MRS®

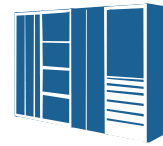

Page 114

CNC storage and transport systems



Page 148

Workbenches



Page 176

Multi-Board

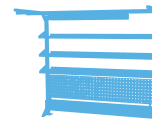

Page 262

workraster - the structured one



Page 316

workergo - the versatile one



Page 334

workline - the highest one



Page 356



Drawer cabinets





T500 series | Drawer cabinets and divider materials

Page 44



T500 series | Individual equipment

Page 64



T736 series | Drawer cabinets and divider materials

Page 68



T736 series | Individual equipment

Page 98



Accessories and spare parts for all series

Page 104



New

Locking systems

Page 110

Drawer cabinets

All series offer:

- Secure central locking with "B+H locking system", theft-proof, combination locking systems possible
- Pull-out 100 % with various drawer load capacities of 50 - 300 kg
- Increased security against tipping over through single drawer pull-out, only one drawer can be opened at a time
- Very stable housing with reinforced frame
- Powder coating in 15 standard colours in eco-friendly painting procedure, two-colour paint of standard colours without surcharge
- Production exclusively in Germany



Grid subdivision

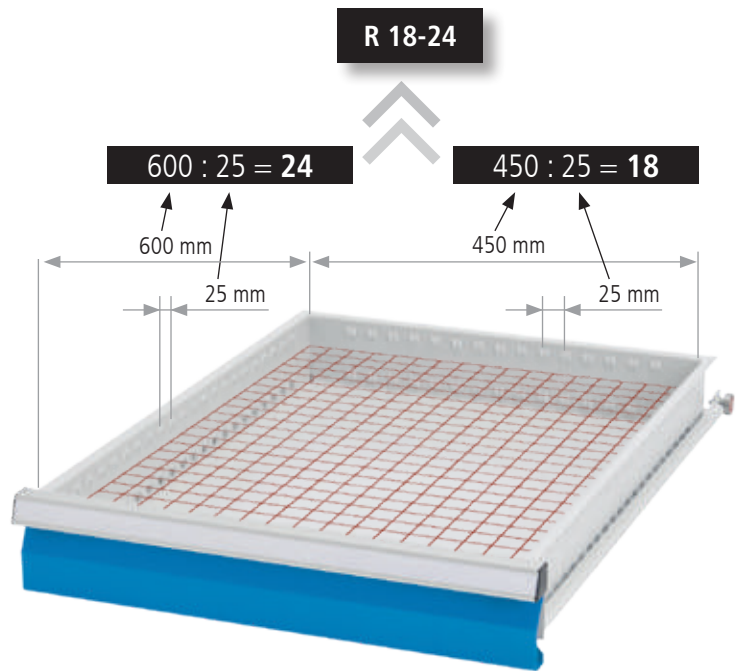

Usable drawer dimension

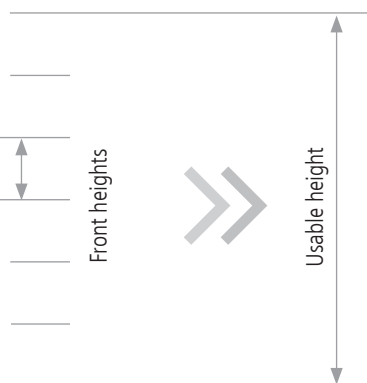

Drawer subdivision



Subdivision & accessories

Drawer cabinets

Space-saving - safe - variable

T500



Features

3 widths:

- **R 18-16:** width 530 mm
- **R 24-16:** width 680 mm
- **R 36-16:** width 980 mm

Housing depth 500 mm

- Internal drawer depth generally 400 mm

New heights

Different heights:

- **R 18-16:** height: 469, 519, 619, 719, 819, 919, 1019, 1119, 1219, 1319, 1419 und 1519 mm
- **R 24-16:** height 519, 619, 719, 819, 919, 1019, 1119, 1219, 1319, 1419 und 1519 mm
- **R 36-16:** height 619, 719, 819, 919, 1019, 1119, 1219, 1319, 1419 und 1519 mm

- Integrated aluminium handle bars flush with housing
- Galvanised drawers **with slotted side walls on a 50 mm grid** for dividers – fast, comprehensive, rational subdivision is guaranteed
- Drawers with front heights: 75, 100, 150, 200, 250 and 300 mm
- **Cylinder lock with 180° closure**
- Cabinet housing, maximum load of up to 1.2 t

- Ball bearing guides
- Full pull-out (FP) 100 %
- Load capacity either 50 kg or 75 kg
- **Only a load capacity of 50 kg is possible for drawers with a front height of 75 mm**



New heights



Series	Series	Series	Series
T500	T500	T500	T500



Housing W x D	Housing W x D	Housing W x D	Housing W x D
380 x 500	530 x 500	680 x 500	980 x 500

Housing height	Usable heights	Usable heights	Usable heights	Usable heights
215	150	–	–	–
365	300	–	–	–
465	400	–	–	–
469	–	350	–	–
519	–	400	400	–
619	–	500	500	500
719	–	600	600	600
819	–	700	700	700
919	–	800	800	800
1019	–	900	900	900
1219	–	1000	1000	1000
1119	–	1100	1100	1100
1319	–	1200	1200	1200
1419	–	1300	1300	1300
1519	–	1400	1400	1400



Drawer W x D	Drawer W x D	Drawer W x D	Drawer W x D
300 x 400	450 x 400	600 x 400	900 x 400

Front height	Shell height	Load capacity	Load capacity	Load capacity	Load capacity
50	–	–	–	–	–
75	59	50 kg	50 kg	50 kg	50 kg
100	85	50 / 75 kg	50 / 75 kg	50 / 75 kg	50 / 75 kg
125	–	–	–	–	–
150	135	50 / 75 kg	50 / 75 kg	50 / 75 kg	50 / 75 kg
175	–	–	–	–	–
200	185	50 / 75 kg	50 / 75 kg	50 / 75 kg	50 / 75 kg
250	185	50 / 75 kg	50 / 75 kg	50 / 75 kg	50 / 75 kg
300	185	50 / 75 kg	50 / 75 kg	50 / 75 kg	50 / 75 kg
400	–	–	–	–	–

Series	Series	Series	Series
T500	T500	T500	T500
T500 12-16	T500 18-16	T500 24-16	T500 36-16

Grid:	R 12-16	R 18-16	R 24-16	R 36-16
-------	---------	---------	---------	---------

All dimensions in mm

Grid: R 12-14 R 24-12 R 12-16 **R 18-16** R 24-16 R 36-16 R 18-24 R 24-24 R 36-24 R 48-24

i From a height of 1119 mm a floor
Floor mounting required



Usable height 350 to 1400 mm
Example:
Usable height 500 mm
Item no.
01.046

Number of drawers (front height) Example:
4 drawers
Usable height 500 mm

Complete order example:
Item no.
01.046 +
3x 60.046.100VA
1x 60.046.200VA

Housing including locking system, cylinder lock and two keys

New heights



01.045

01.046

01.047

01.049

01.040

Total height = usable height + 119 mm

Item no.	Dimensions in mm (WxDxH)	Usable height in mm
01.044	530 x 500 x 469	350
01.045	530 x 500 x 519	400
01.046	530 x 500 x 619	500
01.047	530 x 500 x 719	600
01.048	530 x 500 x 819	700
01.049	530 x 500 x 919	800
01.040	530 x 500 x 1019	900
01.0411	530 x 500 x 1119	1000
01.0412	530 x 500 x 1219	1100
01.0413	530 x 500 x 1319	1200
01.0414	530 x 500 x 1419	1300
01.0415	530 x 500 x 1519	1400



 Please visit our drawer cabinet configurator
www.bedrunka-hirth.de



Drawers incl. rails

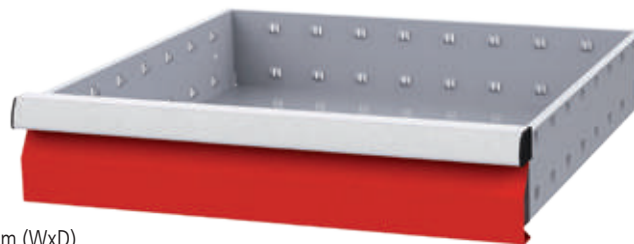

- Usable drawer dimension: 450 x 400 mm (WxD)
- Drawers with full pull-out 100%

Item no.	Front height in mm	Shell height in mm	Usable height in mm	Load capacity
60.046.075VA	75	59	60	50 kg
60.046.100VA	100	85	90	50 kg
60.046.150VA	150	135	140	50 kg
60.046.200VA	200	185	190	50 kg
60.046.250VA	250	185	240	50 kg
60.046.300VA	300	185	290	50 kg
60.046.100VA-75	100	85	90	75 kg
60.046.150VA-75	150	135	140	75 kg
60.046.200VA-75	200	185	190	75 kg
60.046.250VA-75	250	185	240	75 kg
60.046.300VA-75	300	185	290	75 kg

Possible variants as examples

Front height/usable height	350	400	500	500	700	700	700	800	900	900	900	900
75	2x	–	2x	–	–	2x	–	–	4x	2x	–	–
100	2x	4x	–	2x	2x	1x	2x	4x	–	2x	1x	–
150	–	–	1x	2x	–	–	2x	–	2x	2x	2x	2x
200	–	–	1x	–	1x	2x	1x	2x	–	–	1x	–
250	–	–	–	–	–	1x	–	–	–	1x	–	–
300	–	–	–	–	1x	–	–	–	1x	–	1x	2x

530 x 500 x 619 mm (W x D x H)

- Welded sheet steel construction
- Housing: powder-coated
- Drawers: galvanised
- Central locking
- Drawers with full pull-out 100%
- Load capacity of drawers either 50 kg or 75 kg
- Drawers with front height 75 mm only with load capacity 50 kg possible**
- Drawer guides on ball-bearings
- Individual pull-out lock
- Individual locking per drawer possible
- Handle bars with insertable labelling strip
- Drawer front height: 75, 100, 150, 200, 250, 300 mm
- Usable drawer dimension: 450 x 400 mm
- Individual arrangements see page 46/47

Suitable divider material can be found on page 51

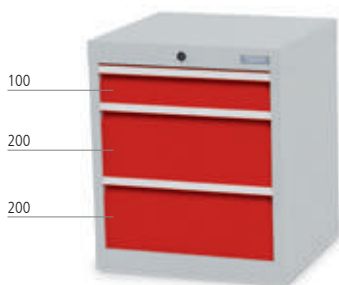

3x drawer

Item no.	Load capacity
46.102	50 kg
46.102-75	75 kg

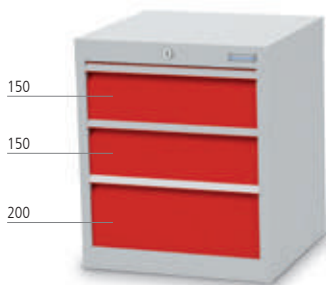

3x drawer

Item no.	Load capacity
46.021	50 kg
46.021-75	75 kg



4x drawer

Item no.	Load capacity
46.220	50 kg
46.220-75	75 kg

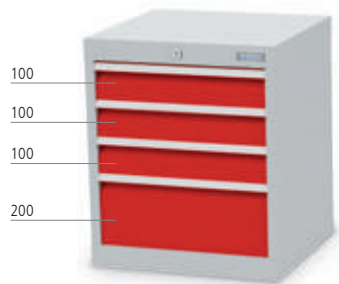

4x drawer

Item no.	Load capacity
46.301	50 kg
46.301-75	75 kg



5x drawer

Item no.	Load capacity
46.2210	50 kg
46.2210-75	75 kg

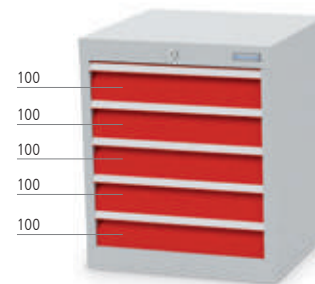

5x drawer

Item no.	Load capacity
46.500	50 kg
46.500-75	75 kg

530 x 500 x 819 mm (W x D x H)

- Welded sheet steel construction
- Housing: powder-coated
- Drawers: galvanised
- Central locking
- Drawers with full pull-out 100%
- Load capacity of drawers either 50 kg or 75 kg
- **Drawers with front height 75 mm only with load capacity 50 kg possible**
- Drawer guides on ball-bearings
- Individual pull-out lock
- Individual locking per drawer possible
- Handle bars with insertable labelling strip
- Drawer front height: 75, 100, 150, 200, 250, 300 mm
- Usable drawer dimension: 450 x 400 mm
- Individual arrangements see page 46/47



Pin-Code

RFID

Equip your drawer cabinet with an E-lock. More information can be found on page 110



■ 4x drawer

Item no.	Load capacity
48.022	50 kg
48.022-75	75 kg



■ 5x drawer

Item no.	Load capacity
48.21101	50 kg
48.21101-75	75 kg



■ 5x drawer

Item no.	Load capacity
48.140	50 kg
48.140-75	75 kg



■ 6x drawer

Item no.	Load capacity
48.501	50 kg
48.501-75	75 kg

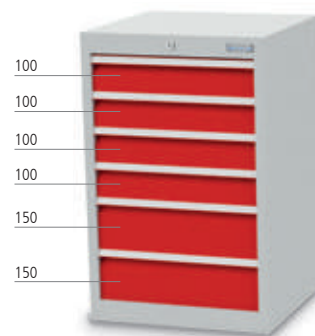

■ 6x drawer

Item no.	Load capacity
48.420	50 kg
48.420-75	75 kg

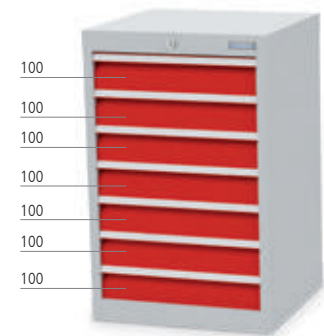

■ 7x drawer

Item no.	Load capacity
48.700	50 kg
48.700-75	75 kg

Grid: R 12-14 R 24-12 R 12-16 **R 18-16** R 24-16 R 36-16 R 18-24 R 24-24 R 36-24 R 48-24

530 x 500 x 1019 mm (W x D x H)

- Welded sheet steel construction
- Housing: powder-coated
- Drawers: galvanised
- Central locking
- Drawers with full pull-out 100%
- Load capacity of drawers either 50 kg or 75 kg
- Drawers with front height 75 mm only with load capacity 50 kg possible**
- Drawer guides on ball-bearings
- Individual pull-out lock
- Individual locking per drawer possible
- Handle bars with insertable labelling strip
- Drawer front height: 75, 100, 150, 200, 250, 300 mm
- Usable drawer dimension: 450 x 400 mm
- Individual arrangements see page 46/47

Suitable divider material can be found on page 51

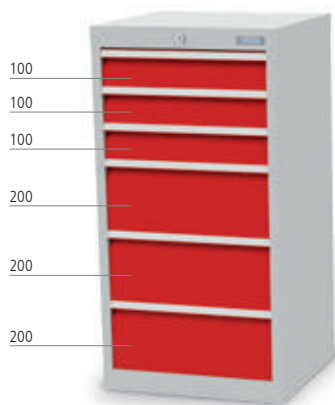

6x drawer

Item no.	Load capacity
40.303	50 kg
40.303-75	75 kg

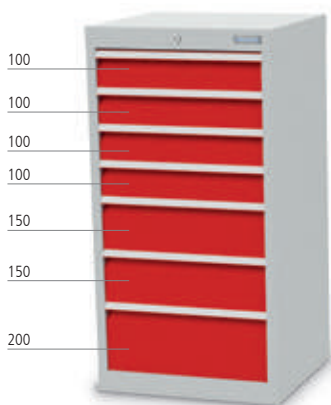

7x drawer

Item no.	Load capacity
40.421	50 kg
40.421-75	75 kg

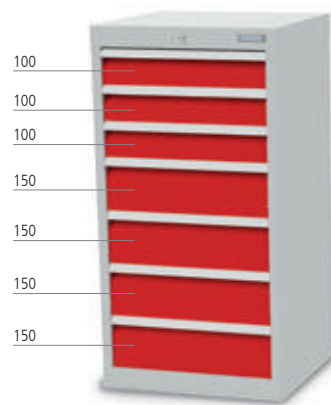

7x drawer

Item no.	Load capacity
40.340	50 kg
40.340-75	75 kg

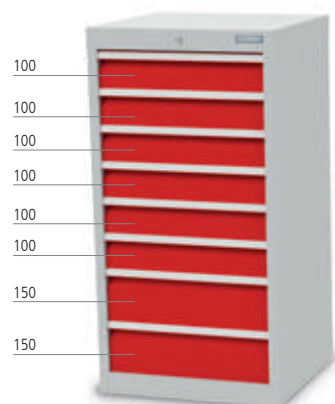

8x drawer

Item no.	Load capacity
40.620	50 kg
40.620-75	75 kg

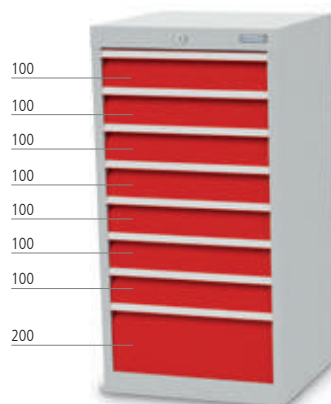

8x drawer

Item no.	Load capacity
40.701	50 kg
40.701-75	75 kg

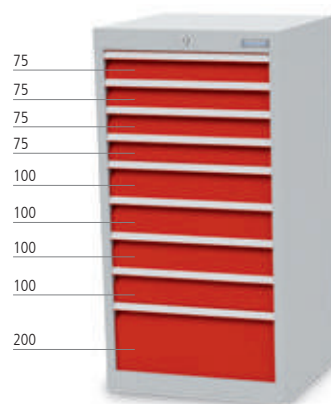

9x drawer

Item no.	Load capacity
40.44010	50 kg
40.44010-75	75 kg



Drawer inserts | ABS



Small parts boxes | 12 parts

- 3x SPB 150 x 150 mm
- 4x SPB 75 x 150 mm
- 4x SPB 75 x 75 mm
- 1x CCR 450 mm

Item no.	Front height in mm
146-132-075	75
146-132	100



Trough plates | 29 parts

- 4x TP with 4 troughs
- 2x TP with 3 troughs
- 16x SDIV for 4 troughs
- 6x SDIV for 3 troughs
- 1x CCR 450 mm

Item no.	Front height in mm
146-130-075	75
146-130	100



Ribbed rubber insert | oil-proof

- 450 x 400 mm
- Smooth closing of the drawer also in connection with metal drawer subdivision
- Applies to all front heights

Item no.
65.046.530

Metal divider | galvanised sheet steel



Metal divider | 8 parts

- 2x CCR 400 mm
- 6x DIV 150 mm

Item no.	Front height in mm
146-139-75	75
146-139-100	100
146-139-150	150
146-139-200	200/250/300



Metal divider | 5 parts

- 1x CCR 400 mm
- 2x DIV 200 mm
- 2x DIV 250 mm

Item no.	Front height in mm
146-135-75	75
146-135-100	100
146-135-150	150
146-135-200	200/250/300



Metal divider | 9 parts

- 3x CCR 400 mm
- 5x DIV 100 mm
- 1x DIV 150 mm

Item no.	Front height in mm
146-137-75	75
146-137-100	100
146-137-150	150
146-137-200	200/250/300



Metal divider | 2 parts

- 2x CCR 400 mm

Item no.	Front height in mm
146-140-75	75
146-140-100	100
146-140-150	150
146-140-200	200/250/300



Metal divider | 5 parts

- 1x CCR 400 mm
- 2x DIV 300 mm
- 2x DIV 150 mm

Item no.	Front height in mm
146-141-75	75
146-141-100	100
146-141-150	150
146-141-200	200/250/300



Metal divider | 15 parts

- 3x CCR 400 mm
- 9x DIV 100 mm
- 3x DIV 150 mm

Item no.	Front height in mm
146-142-75	75
146-142-100	100
146-142-150	150
146-142-200	200/250/300

CCR = Centre compartment rails, DIV = Divider, SPB = Small Parts Box, TP = Trough Plate, SDIV = Slot-in divider

Grid: R 12-14 R 24-12 R 12-16 R 18-16 **R 24-16** R 36-16 R 18-24 R 24-24 R 36-24 R 48-24

i From a height of 1319 mm a floor
Floor mounting required

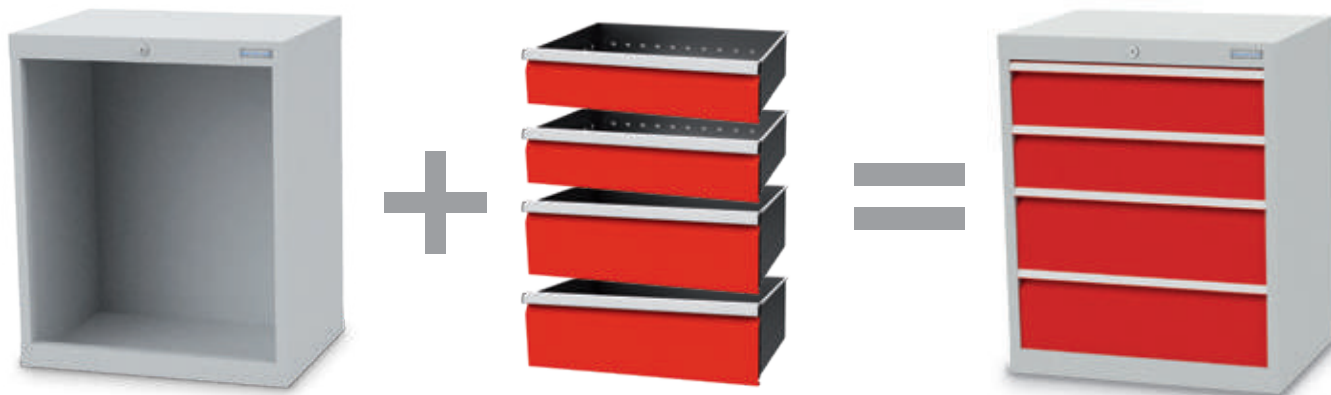

Usable height 400 to 1400 mm
Example:
Usable height 700 mm
Item no.
01.068

Number of drawers (front height)
Example:
4 drawers
Usable height 700 mm

Complete order example:
Item no.
01.068 +
2x 60.068.150VA
2x 60.068.200VA

Housing including locking system, cylinder lock and two keys

New heights

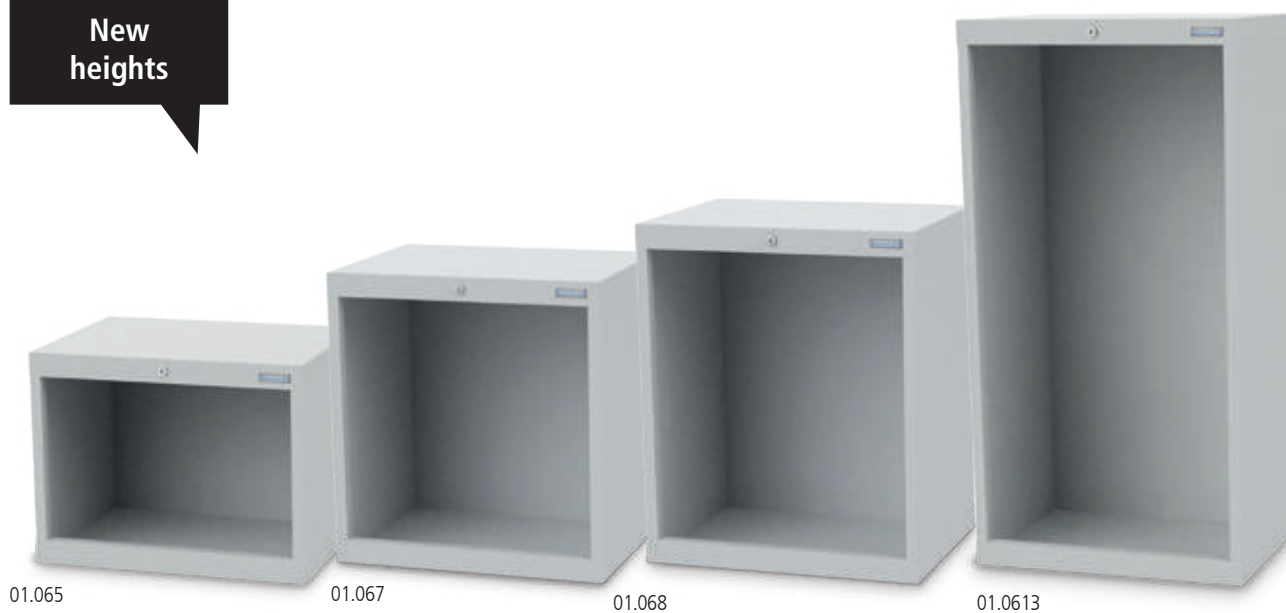

Total height = usable height + 119 mm

Item no.	Dimensions in mm (WxDxH)	Usable height in mm
01.065	680 x 500 x 519	400
01.066	680 x 500 x 619	500
01.067	680 x 500 x 719	600
01.068	680 x 500 x 819	700
01.069	680 x 500 x 919	800
01.060	680 x 500 x 1019	900
01.0611	680 x 500 x 1119	1000
01.0612	680 x 500 x 1219	1100
01.0613	680 x 500 x 1319	1200
01.0614	680 x 500 x 1419	1300
01.0615	680 x 500 x 1519	1400



 Please visit our drawer cabinet configurator
www.bedrunka-hirth.de



Drawers incl. rails



- Usable drawer dimension: 600 x 400 mm (WxD)
- Drawers with full pull-out 100%

Item no.	Front height in mm	Shell height in mm	Usable height in mm	Load capacity
60.068.075VA	75	59	60	50 kg
60.068.100VA	100	85	90	50 kg
60.068.150VA	150	135	140	50 kg
60.068.200VA	200	185	190	50 kg
60.068.250VA	250	185	240	50 kg
60.068.300VA	300	185	290	50 kg
60.068.100VA-75	100	85	90	75 kg
60.068.150VA-75	150	135	140	75 kg
60.068.200VA-75	200	185	190	75 kg
60.068.250VA-75	250	185	240	75 kg
60.068.300VA-75	300	185	290	75 kg

Possible variants as examples

Front height/usable height	400	500	500	600	700	700	800	900	900	900	1200
75	–	2x	–	–	2x	–	–	4x	2x	–	–
100	4x	–	2x	3x	1x	2x	4x	–	2x	1x	3x
150	–	1x	2x	–	–	2x	–	2x	2x	2x	2x
200	–	1x	–	–	2x	1x	2x	–	–	1x	3x
250	–	–	–	–	1x	–	–	–	1x	–	–
300	–	–	–	1x	–	–	–	1x	–	1x	–

680 x 500 x 819 mm (W x D x H)

- Welded sheet steel construction
- Housing: powder-coated
- Drawers: galvanised
- Central locking
- Drawers with full pull-out 100%
- Load capacity of drawers either 50 kg or 75 kg
- Drawers with front height 75 mm only with load capacity 50 kg possible**
- Drawer guides on ball-bearings
- Individual pull-out lock
- Individual locking per drawer possible
- Handle bars with insertable labelling strip
- Drawer front height: 75, 100, 150, 200, 250, 300 mm
- Usable drawer dimension: 600 x 400 mm
- Individual arrangements see page 52/53

Suitable divider material can be found on page 57



4x drawer

Item no.	Load capacity
68.022	50 kg
68.022-75	75 kg

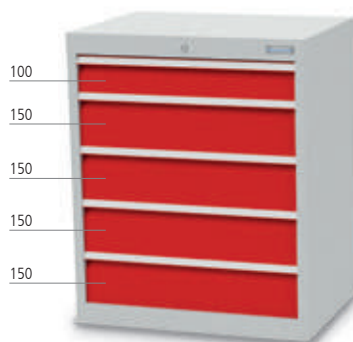

5x drawer

Item no.	Load capacity
68.140	50 kg
68.140-75	75 kg



6x drawer

Item no.	Load capacity
68.501	50 kg
68.501-75	75 kg



6x drawer

Item no.	Load capacity
68.420	50 kg
68.420-75	75 kg

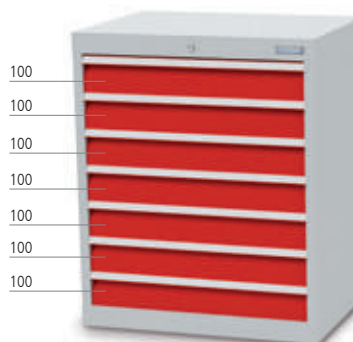

7x drawer

Item no.	Load capacity
68.700	50 kg
68.700-75	75 kg

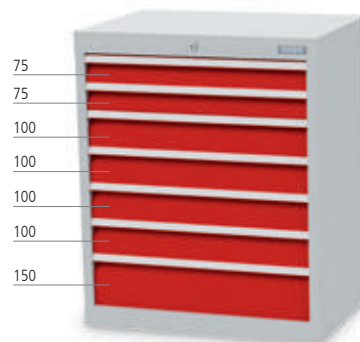

7x drawer

Item no.	Load capacity
68.24100	50 kg
68.24100-75	75 kg

680 x 500 x 1019 mm (W x D x H)

- Welded sheet steel construction
- Housing: powder-coated
- Drawers: galvanised
- Central locking
- Drawers with full pull-out 100%
- Load capacity of drawers either 50 kg or 75 kg
- **Drawers with front height 75 mm only with load capacity 50 kg possible**
- Drawer guides on ball-bearings
- Individual pull-out lock
- Individual locking per drawer possible
- Handle bars with insertable labelling strip
- Drawer front height: 75, 100, 150, 200, 250, 300 mm
- Usable drawer dimension: 600 x 400 mm
- Individual arrangements see page 74/75



Pin-Code

RFID

Equip your drawer cabinet with an E-lock. More information can be found on page 110



■ 6x drawer

Item no.	Load capacity
60.303	50 kg
60.303-75	75 kg



■ 7x drawer

Item no.	Load capacity
60.421	50 kg
60.421-75	75 kg

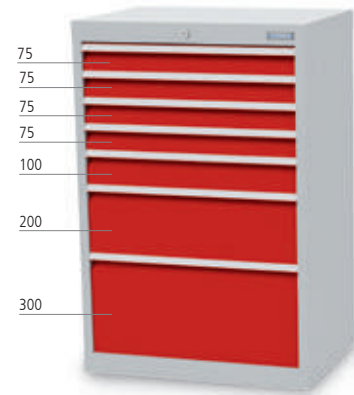

■ 7x drawer

Item no.	Load capacity
60.41011	50 kg
60.41011-75	75 kg



■ 7x drawer

Item no.	Load capacity
60.340	50 kg
60.340-75	75 kg

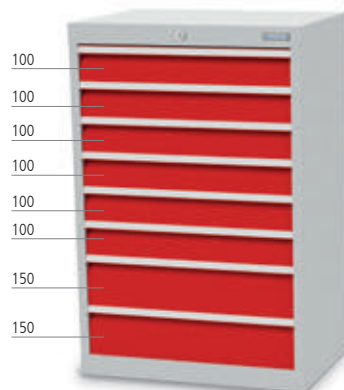

■ 8x drawer

Item no.	Load capacity
60.620	50 kg
60.620-75	75 kg

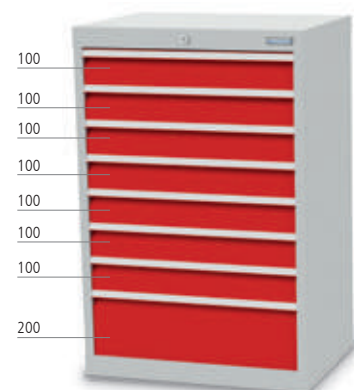

■ 8x drawer

Item no.	Load capacity
60.701	50 kg
60.701-75	75 kg

Grid: R 12-14 R 24-12 R 12-16 R 18-16 **R 24-16** R 36-16 R 18-24 R 24-24 R 36-24 R 48-24

680 x 500 x 1319 mm (W x D x H)

- Welded sheet steel construction
- Housing: powder-coated
- Drawers: galvanised
- Central locking
- Drawers with full pull-out 100%
- Load capacity of drawers either 50 kg or 75 kg
- Drawers with front height 75 mm only with load capacity 50 kg possible**
- Drawer guides on ball-bearings
- Individual pull-out lock
- Individual locking per drawer possible
- Handle bars with insertable labelling strip
- Drawer front height: 75, 100, 150, 200, 250, 300 mm
- Usable drawer dimension: 600 x 400 mm
- Individual arrangements see page 52/53

Suitable divider material can be found on page 57

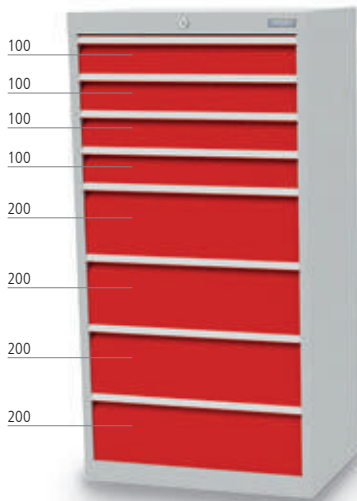

8x drawer

Item no.	Load capacity
613.404	50 kg
613.404-75	75 kg

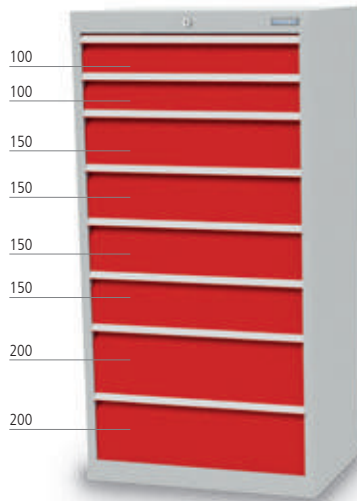

8x drawer

Item no.	Load capacity
613.242	50 kg
613.242-75	75 kg

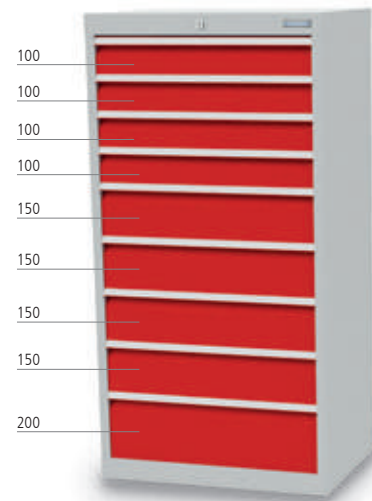

9x drawer

Item no.	Load capacity
613.441	50 kg
613.441-75	75 kg

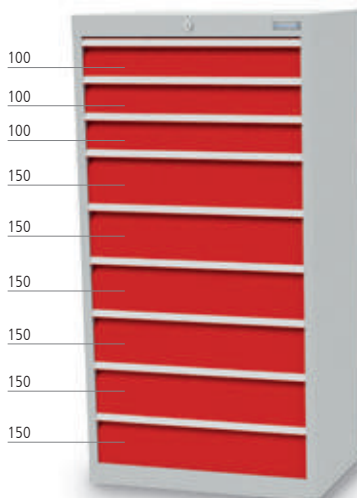

9x drawer

Item no.	Load capacity
613.360	50 kg
613.360-75	75 kg

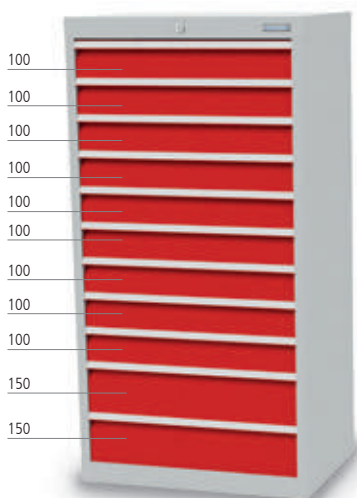

11x drawer

Item no.	Load capacity
613.920	50 kg
613.920-75	75 kg

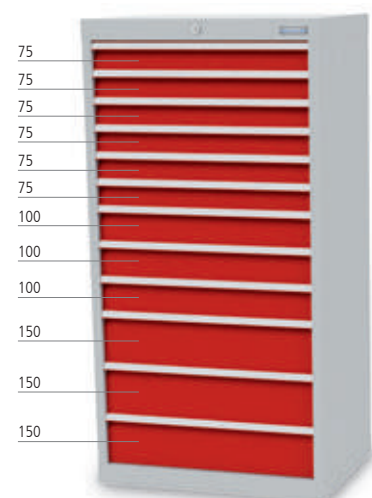

12x drawer

Item no.	Load capacity
613.63300	50 kg
613.63300-75	75 kg

Drawer inserts | ABS



Trough plates | 37 parts

- 4x TP with 4 troughs
- 2x TP with 3 troughs
- 2x TP with 2 troughs
- 16x SDIV for 4 troughs
- 6x SDIV for 3 troughs
- 4x SDIV for 2 troughs
- 1x CCR 600 mm
- 2x DIV 100 mm

Item no.	Front height in mm
168-130-075	75
168-130	100



Small parts boxes | 16 parts

- 5x SPB 150 x 150 mm
- 4x SPB 75 x 150 mm
- 4x SPB 75 x 75 mm
- 1x CCR 600 mm
- 2x DIV 100 mm

Item no.	Front height in mm
168-132-075	75
168-132	100



Ribbed rubber insert | oil-proof

- 600 x 400 mm
- Smooth closing of the drawer also in connection with metal drawer subdivision
- Applies to all front heights

Item no.
65.068.530

Metal divider | galvanised sheet steel



Metal divider | 5 parts

- 1x CCR 400 mm
- 4x DIV 300 mm

Item no.	Front height in mm
168-144-75	75
168-144-100	100
168-144-150	150
168-144-200	200/250/300



Metal divider | 3 parts

- 1x CCR 400 mm
- 2x DIV 300 mm

Item no.	Front height in mm
168-146-75	75
168-146-100	100
168-146-150	150
168-146-200	200/250/300



Metal divider | 6 parts

- 2x CCR 400 mm
- 4x DIV 200 mm

Item no.	Front height in mm
168-145-75	75
168-145-100	100
168-145-150	150
168-145-200	200/250/300



Metal divider | 11 parts

- 3x CCR 400 mm
- 8x DIV 150 mm

Item no.	Front height in mm
168-139-75	75
168-139-100	100
168-139-150	150
168-139-200	200/250/300



Metal divider | 7 parts

- 2x CCR 400 mm
- 5x DIV 200 mm

Item no.	Front height in mm
168-136-75	75
168-136-100	100
168-136-150	150
168-136-200	200/250/300



Metal divider | 7 parts

- 3x CCR 400 mm
- 4x DIV 150 mm

Item no.	Front height in mm
168-137-75	75
168-137-100	100
168-137-150	150
168-137-200	200/250/300

CCR = Centre compartment rails, DIV = Divider, SPB = Small Parts Box, TP = Trough Plate, SDIV = Slot-in divider

Grid: R 12-14 R 24-12 R 12-16 R 18-16 R 24-16 **R 36-16** R 18-24 R 24-24 R 36-24 R 48-24

i From a height of 1319 mm a floor
Floor mounting required

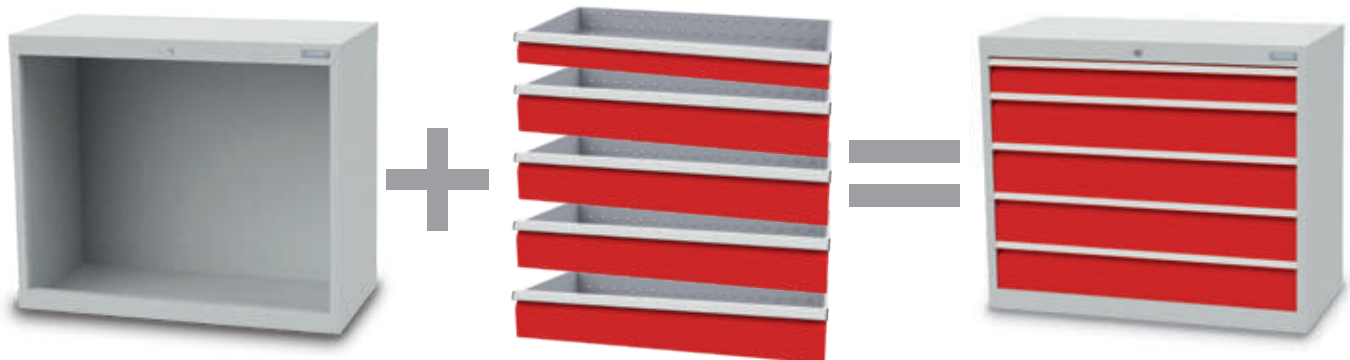

Usable height 500 to 1400 mm
Example:
Usable height 700 mm
Item no.
01.098

Number of drawers (front height)
Example:
4 drawers
Usable height 700 mm

Complete order example:
Item no.
01.098 +
1x 60.098.100VA
4x 60.098.150VA

Housing including locking system, cylinder lock and two keys

New heights



01.096



01.099



01.0913

Total height = usable height + 119 mm

Item no.	Dimensions in mm (WxDxH)	Usable height in mm
01.095	980 x 500 x 519	400
01.096	980 x 500 x 619	500
01.097	980 x 500 x 719	600
01.098	980 x 500 x 819	700
01.099	980 x 500 x 919	800
01.090	980 x 500 x 1019	900
01.0911	980 x 500 x 1119	1000
01.0912	980 x 500 x 1219	1100
01.0913	980 x 500 x 1319	1200
01.0194	980 x 500 x 1419	1300
01.0195	980 x 500 x 1519	1400



 Please visit our drawer cabinet configurator
www.bedrunka-hirth.de



Drawers incl. rails



- Usable drawer dimension: 900 x 400 mm (WxD)
- Drawers with full pull-out 100%

Item no.	Front height in mm	Shell height in mm	Usable height in mm	Load capacity
60.098.075VA	75	59	60	50 kg
60.098.100VA	100	85	90	50 kg
60.098.150VA	150	135	140	50 kg
60.098.200VA	200	185	190	50 kg
60.098.250VA	250	185	240	50 kg
60.098.300VA	300	185	290	50 kg
60.098.100VA-75	100	85	90	75 kg
60.098.150VA-75	150	135	140	75 kg
60.098.200VA-75	200	185	190	75 kg
60.098.250VA-75	250	185	240	75 kg
60.098.300VA-75	300	185	290	75 kg

Possible variants as examples

Front height/usable height	500	500	700	700	700	700	800	900	900	1200
75	2x	–	–	–	2x	–	–	2x	–	–
100	–	2x	2x	5x	1x	2x	4x	2x	1x	3x
150	1x	2x	–	–	–	2x	–	2x	2x	2x
200	1x	–	1x	1x	2x	1x	2x	–	1x	3x
250					1x			1x		
300	–	–	1x	–	–	–	–	1x	1x	–

Grid: R 12-14 R 24-12 R 12-16 R 18-16 R 24-16 **R 36-16** R 18-24 R 24-24 R 36-24 R 48-24

980 x 500 x 819 mm (W x D x H)

- Welded sheet steel construction
- Housing: powder-coated
- Drawers: galvanised
- Central locking
- Drawers with full pull-out 100%
- Load capacity of drawers either 50 kg or 75 kg
- **Drawers with front height 75 mm only with load capacity 50 kg possible**
- Drawer guides on ball-bearings
- Individual pull-out lock
- Individual locking per drawer possible
- Handle bars with insertable labelling strip
- Drawer front height: 75, 100, 150, 200, 250, 300 mm
- Usable drawer dimension: 900 x 400 mm
- Individual arrangements see page 58/59

Suitable divider material can be found on page 63



▪ 5x drawer

Item no.	Load capacity
98.140	50 kg
98.140-75	75 kg



▪ 5x drawer

Item no.	Load capacity
98.221	50 kg
98.221-75	75 kg



▪ 6x drawer

Item no.	Load capacity
98.501	50 kg
98.501-75	75 kg



▪ 6x drawer

Item no.	Load capacity
98.420	50 kg
98.420-75	75 kg



▪ 7x drawer

Item no.	Load capacity
98.700	50 kg
98.700-75	75 kg



▪ 8x drawer

Item no.	Load capacity
98.44000	50 kg
98.44000-75	75 kg

980 x 500 x 1019 mm (W x D x H)

- Welded sheet steel construction
- Housing: powder-coated
- Drawers: galvanised
- Central locking
- Drawers with full pull-out 100%
- Load capacity of drawers either 50 kg or 75 kg
- **Drawers with front height 75 mm only with load capacity 50 kg possible**
- Drawer guides on ball-bearings
- Individual pull-out lock
- Individual locking per drawer possible
- Handle bars with insertable labelling strip
- Drawer front height: 75, 100, 150, 200, 250, 300 mm
- Usable drawer dimension: 900 x 400 mm
- Individual arrangements see page 58/59



Pin-Code

RFID

Equip your drawer cabinet with an E-lock. More information can be found on page 110



■ 6x drawer

Item no.	Load capacity
90.303	50 kg
90.303-75	75 kg



■ 7x drawer

Item no.	Load capacity
90.421	50 kg
90.421-75	75 kg

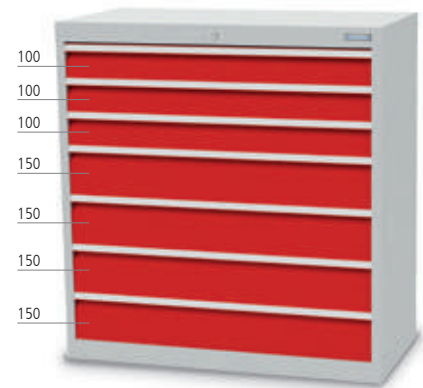

■ 7x drawer

Item no.	Load capacity
90.340	50 kg
90.340-75	75 kg



■ 8x drawer

Item no.	Load capacity
90.620	50 kg
90.620-75	75 kg



■ 8x drawer

Item no.	Load capacity
90.23300	50 kg
90.23300-75	75 kg

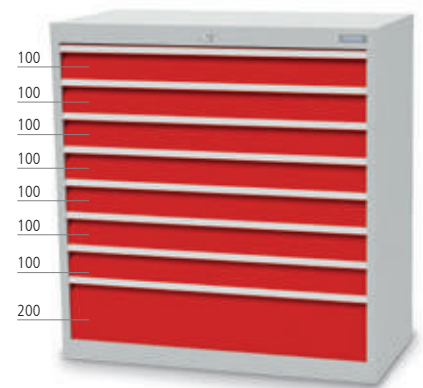

■ 8x drawer

Item no.	Load capacity
90.701	50 kg
90.701-75	75 kg

Grid: R 12-14 R 24-12 R 12-16 R 18-16 R 24-16 **R 36-16** R 18-24 R 24-24 R 36-24 R 48-24

980 x 500 x 1319 mm (W x D x H)

- Welded sheet steel construction
- Housing: powder-coated
- Drawers: galvanised
- Central locking
- Drawers with full pull-out 100%
- Load capacity of drawers either 50 kg or 75 kg
- Drawers with front height 75 mm only with load capacity 50 kg possible**
- Drawer guides on ball-bearings
- Individual pull-out lock
- Individual locking per drawer possible
- Handle bars with insertable labelling strip
- Drawer front height: 75, 100, 150, 200, 250, 300 mm
- Usable drawer dimension: 900 x 400 mm
- Individual arrangements see page 58/59

Suitable divider material can be found on page 63

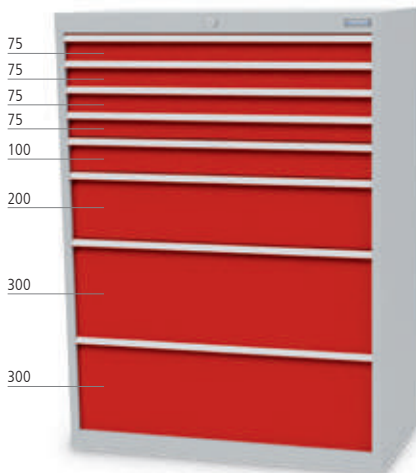

8x drawer

Item no.	Load capacity
913.41012	50 kg
913.41012-75	75 kg

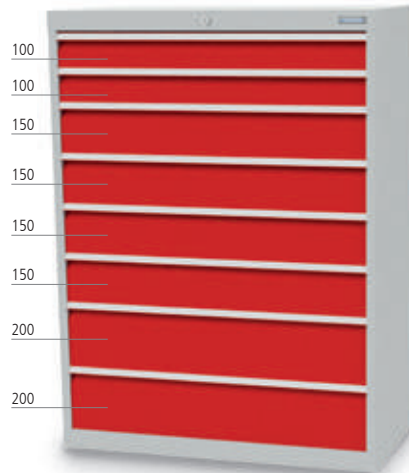

8x drawer

Item no.	Load capacity
913.242	50 kg
913.242-75	75 kg

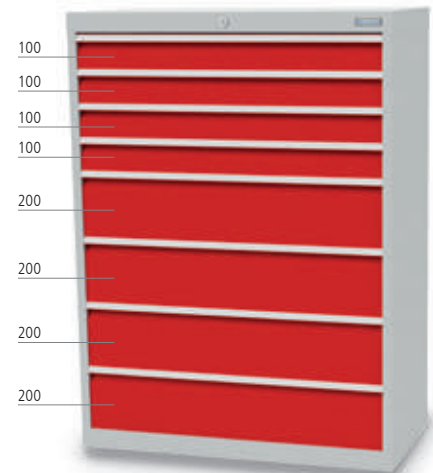

8x drawer

Item no.	Load capacity
913.404	50 kg
913.404-75	75 kg

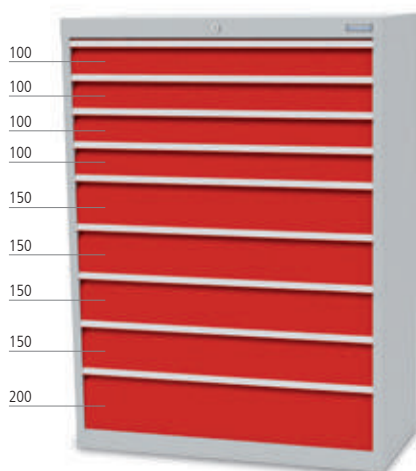

9x drawer

Item no.	Load capacity
913.441	50 kg
913.441-75	75 kg

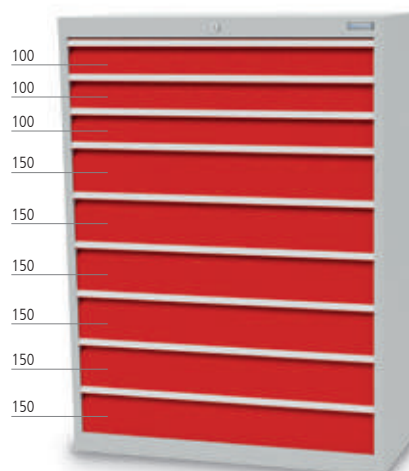

9x drawer

Item no.	Load capacity
913.360	50 kg
913.360-75	75 kg

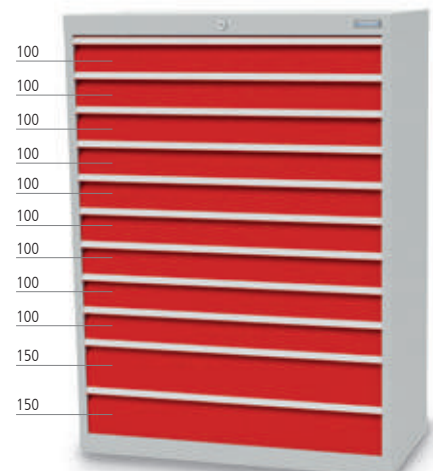

11x drawer

Item no.	Load capacity
913.920	50 kg
913.920-75	75 kg

Drawer inserts | ABS



Small parts boxes | 20 parts

- 9x SPB 150 x 150 mm
- 4x SPB 75 x 150 mm
- 4x SPB 75 x 75 mm
- 1x CCR 900 mm
- 2x DIV 100 mm

Item no.	Front height in mm
198-132-075	75
198-132	100



Trough plates | 47 parts

- 6x TP with 4 troughs
- 4x TP with 3 troughs
- 2x TP with 2 troughs
- 16x SDIV for 4 troughs
- 12x SDIV for 3 troughs
- 4x SDIV for 2 troughs
- 1x CCR 900 mm
- 2x DIV 100 mm

Item no.	Front height in mm
198-130-075	75
198-130	100



Ribbed rubber insert | oil-proof

- 900 x 400 mm
- Smooth closing of the drawer also in connection with metal drawer subdivision
- Applies to all front heights

Item no.
65.098.530

Metal divider | galvanised sheet steel



Metal divider | 9 parts

- 3x CCR 400 mm
- 5x DIV 200 mm
- 1x DIV 300 mm

Item no.	Front height in mm
198-136-75	75
198-136-100	100
198-136-150	150
198-136-200	200/250/300



Metal divider | 7 parts

- 2x CCR 400 mm
- 5x DIV 300 mm

Item no.	Front height in mm
198-146-75	75
198-146-100	100
198-146-150	150
198-146-200	200/250/300



Metal divider | 5 parts

- 2x CCR 400 mm
- 3x DIV 300 mm

Item no.	Front height in mm
198-144-75	75
198-144-100	100
198-144-150	150
198-144-200	200/250/300



Metal divider | 17 parts

- 5x CCR 400 mm
- 12x DIV 150 mm

Item no.	Front height in mm
198-141-75	75
198-141-100	100
198-141-150	150
198-141-200	200/250/300



Metal divider | 11 parts

- 3x CCR 400 mm
- 4x DIV 150 mm
- 4x DIV 300 mm

Item no.	Front height in mm
198-142-75	75
198-142-100	100
198-142-150	150
198-142-200	200/250/300



Metal divider | 14 parts

- 4x CCR 400 mm
- 8x DIV 150 mm
- 2x DIV 300 mm

Item no.	Front height in mm
198-139-75	75
198-139-100	100
198-139-150	150
198-139-200	200/250/300

CCR = Centre compartment rails, DIV = Divider, SPB = Small Parts Box, TP = Trough Plate, SDIV = Slot-in divider

Insertable labelling strip

- Fold up transparent panel and insert label. Press panel down again.
- Labelling strip and transparent cover kit
- Height 20 mm

Item no.	Designation
01.046.007-1	R 18-16
01.068.007-1	R 24-16
01.098.007-1	R 36-16



Divider elements

- Metal divider elements made from high-quality thin sheet metal
- Fine subdivision on the grid 50:50



Centre compartment rail

- Front 75 mm

Item no.	Dimensions in mm (W x H)
20.400.060	400 x 55
20.450.060	450 x 55 Separator rail, rear, crosswise
20.600.060	600 x 55 Separator rail, rear, crosswise
20.900.060	900 x 55 Separator rail, rear, crosswise

Centre compartment rail

- Front 100 mm

Item no.	Dimensions in mm (W x H)
20.400.085	400 x 80
20.450.085	450 x 80 Separator rail, rear, crosswise
20.600.085	600 x 80 Separator rail, rear, crosswise
20.900.085	900 x 80 Separator rail, rear, crosswise



Centre compartment rail

- Front 150 mm

Item no.	Dimensions in mm (W x H)
20.400.135	400 x 130

Centre compartment rail

- Front 200 mm

Item no.	Dimensions in mm (W x H)
20.400.180	400 x 185

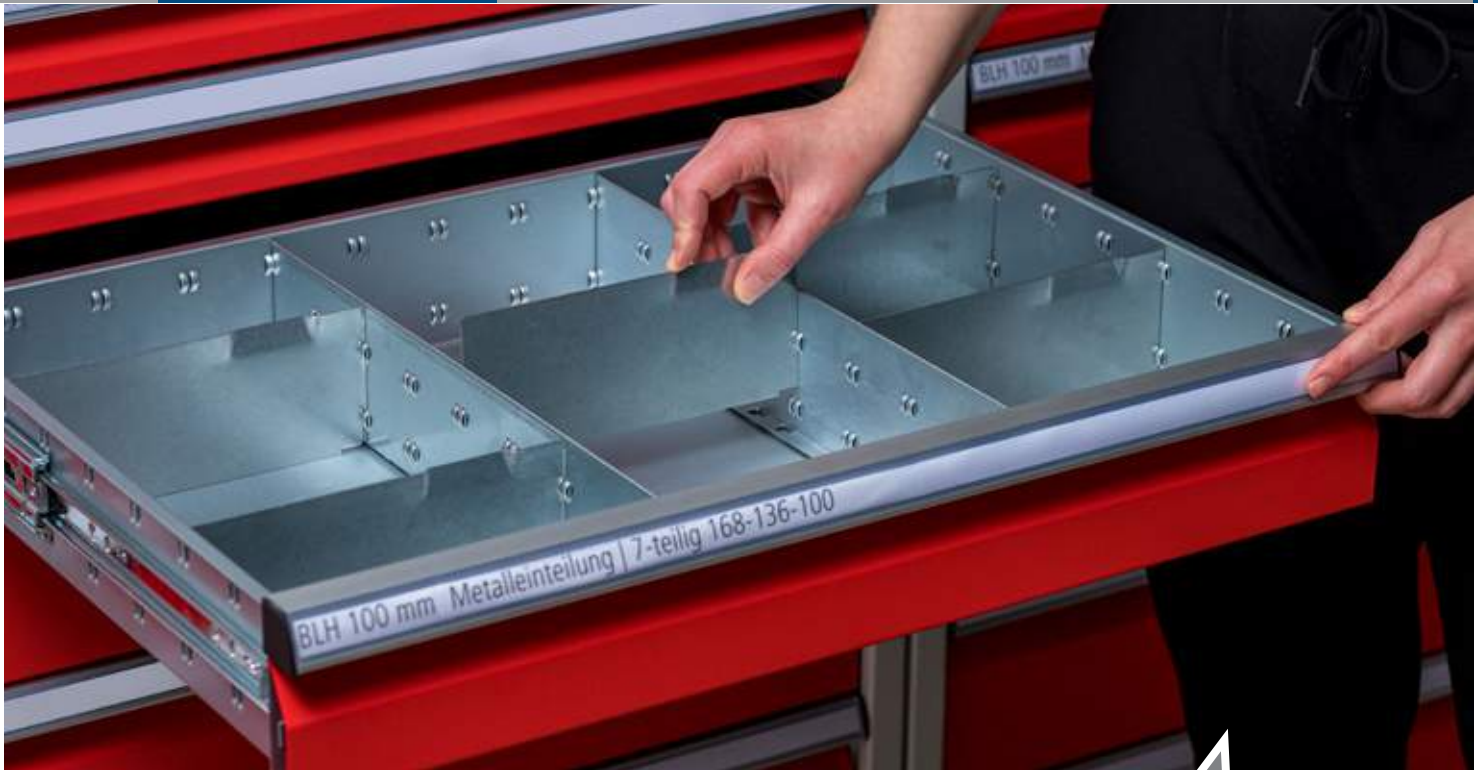

Metal divider, to be fixed between the drawer side and a slotted through or between 2 slotted throughs

Divider

- Front 75 mm

Item no.	Dimensions in mm (W x H)
30.100.060	100 x 55
30.150.060	150 x 55
30.200.060	200 x 55
30.300.060	300 x 55



Divider

- Front 100 mm

Item no.	Dimensions in mm (W x H)
30.100.085	100 x 80
30.150.085	150 x 80
30.200.085	200 x 80
30.300.085	300 x 80



Divider

- Front 150 mm

Item no.	Dimensions in mm (W x H)
30.100.135	100 x 130
30.150.135	150 x 130
30.200.135	200 x 130
30.250.135	250 x 130
30.300.135	300 x 130



Divider

- Front 200, 250, 300 mm

Item no.	Dimensions in mm (W x H)
30.100.185	100 x 180
30.150.185	150 x 180
30.200.185	200 x 180
30.250.185	250 x 180
30.300.185	300 x 180

Individual equipment T500 series



Hinged door for usable height 700 mm

- Hinged doors with twist lock cylinder lock and 2 keys
- With one door, hinges on the right and left are possible

Item no.	Grid	Design	for cabinet width
01.053.700E	R 18-16	one door	530 mm
01.068.700E	R 24-16	one door	680 mm
01.098.700E	R 36-16	two doors	980 mm



Hinged door for usable height 900 mm

- Hinged doors with twist lock cylinder lock and 2 keys
- With one door, hinges on the right and left are possible

Item no.	Grid	Design	for cabinet width
01.053.900E	R 18-16	one door	530 mm
01.068.900E	R 24-16	one door	680 mm
01.098.900E	R 36-16	two doors	980 mm

Hinged door for usable height 800 mm

- Hinged doors with twist lock cylinder lock and 2 keys
- With one door, hinges on the right and left are possible

Item no.	Grid	Design	for cabinet width
01.053.800E	R 18-16	one door	530 mm
01.068.800E	R 24-16	one door	680 mm
01.098.800E	R 36-16	two doors	980 mm

Metal cover upon double doors

- For a cabinet with drawers on top and doors below a metal cover will be fixed upon the doors
- The using height is reduced by 100 mm

Item no.	Grid
01.098.BLFL	R 36-16



Ribbed rubber mat on cabinet

- Oil-proof

Item no.	Dimensions in mm (WxDxH)
65.040.530	530 x 500 x 3
65.060.530	680 x 500 x 3
65.090.530	980 x 500 x 3



Ribbed rubber insert for drawer

- Oil-proof
- Smooth closing of the drawer also in connection with metal drawer subdivision

Item no.	Dimensions in mm (WxDxH)
65.046.530	450 x 400 x 3
65.068.530	600 x 400 x 3
65.098.530	900 x 400 x 3



Non-slip mat secures tools

- Insert for drawer
- Smooth closing of the drawer also in connection with metal drawer subdivision

Item no.	Dimensions in mm (WxDxH)
65.046.531	450 x 400 x 3
65.068.531	600 x 400 x 3
65.098.531	900 x 400 x 3



Cover plate

- Beech multiplex, oiled

Item no.	Dimensions in mm (WxDxH)
67.046.017	530 x 500 x 25
67.068.017	680 x 500 x 25
67.098.017	980 x 500 x 25

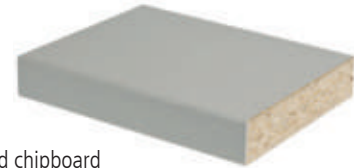

Cover plate

- Melamine resin coated chipboard
- RAL 7035
- 19 mm, screwable

Item no.	Dimensions in mm (WxDxH)
67.046.016	530 x 500 x 19
67.068.016	680 x 500 x 19
67.098.016	980 x 500 x 19



Shelf

Item no.	Dimensions in mm (WxDxH)
04.053.013	475 x 443 x 22
04.060.013	625 x 443 x 22
04.090.013	925 x 443 x 22



Metal roll-off edge on 3 sides

- 20 mm height

Item no.	Dimensions in mm (WxDxH)
66.046.025	530 x 500 x 20
66.068.025	680 x 500 x 20
66.098.025	980 x 500 x 20

New



Machine feet for drawer cabinets

- Load capacity 1200 kg
- plate Ø 50 mm
- Base made of polished and chrome-plated sheet steel
- Easy height adjustment with vibration damping

Item no.	Packaging unit
01.ASF50-M8	Set with 4 pieces

New



Soft PVC workbench covering

- Transparent
- Bluish

Item no.	Dimensions in mm (WxDxH)
0153504TRA	530 x 500 x 4
0168504TRA	680 x 500 x 4
0198504TRA	980 x 500 x 4



Lift truck base

- Cover plate front and rear

Item no.	Dimensions in mm (WxDxH)
01.046.012	530 x 500 x 112
01.068.012	680 x 500 x 112
01.098.012	980 x 500 x 112



Mobile addition

- Aluminium push handle
- Steel panel with 4 steering casters, thereof 2 with locks and push handle for tool cabinet

* without steel plate, the casters are screwed into the frame of the housing



Item no.	Dimensions in mm (WxDxH)	Push handle arrangement	Caster Ø in mm
01.046.008*	530 x 500 x 150	front	80
01.068.008*	680 x 500 x 150	side	80
01.098.008	980 x 500 x 150	side	80
01.046.009*	530 x 500 x 150	front	125
01.068.009*	680 x 500 x 150	side	125
01.098.009	980 x 500 x 150	side	125

Drawer cabinets

Robust - versatile - stable

T736



Features

4 widths:

- **R 18-24:** width 555 mm
- **R 24-24:** width 705 mm
- **R 36-24:** width 1005 mm
- **R 48-24:** width 1305 mm

■ Housing depth 736 mm

- Internal drawer depth generally 600 mm

New heights

Different heights:

- **R 18-24:** height 519, 619, 719, 819, 919, 1019, 1119, 1219, 1319, 1419 und 1519 mm
- **R 24-24:** height 519, 619, 719, 819, 919, 1019, 1119, 1219, 1319, 1419 und 1519 mm
- **R 36-24:** height 519, 619, 719, 819, 919, 1019, 1119, 1219, 1319, 1419 und 1519 mm
- **R 48-24:** height 818, 919, 1019, 1119, 1219, 1319, 1419 und 1519 mm

- Integrated recessed aluminium handle bars flush with housing
- Powder-coated drawers **with slotted side walls on a 25 mm grid** for dividers – fast, comprehensive, rational subdivision is guaranteed

- All drawer cabinets of series T736 with a front height from 75 mm with load capacity 100 kg, can be fitted with **soft close**.

- When placing your order, please indicate the desired number of drawers with soft close.

- Retrofitting on existing drawers is not possible.

- **Please note!**

When opening the drawer, it must stay open for at least 5 seconds because of the soft close cylinder; otherwise the soft close mechanism will be damaged. Perfect functioning is then no longer guaranteed.

- **Cylinder lock with 180° closure**

- Cabinet housing, maximum load of up to 1.5 t



- TÜV-Rheinland certificate: "GS" mark for tested safety

■ Ball bearing guides

- **Full pull-out (FP) 100 %, load capacity 70 kg** (with 50 mm front height)
- **Full pull-out (FP) 100 %, load capacity 100 kg** (from 75 mm front height)
- **Full pull-out (FP) 100 %, load capacity 180 kg** (from 100 mm front height)
- **Full pull-out (FP) 100 %, load capacity 300 kg** (for front height 200, 250 and 300 mm)

■ Drawers with front heights:

50, 75, 100, 125, 150, 175, 200, 250, 300 & 400 mm

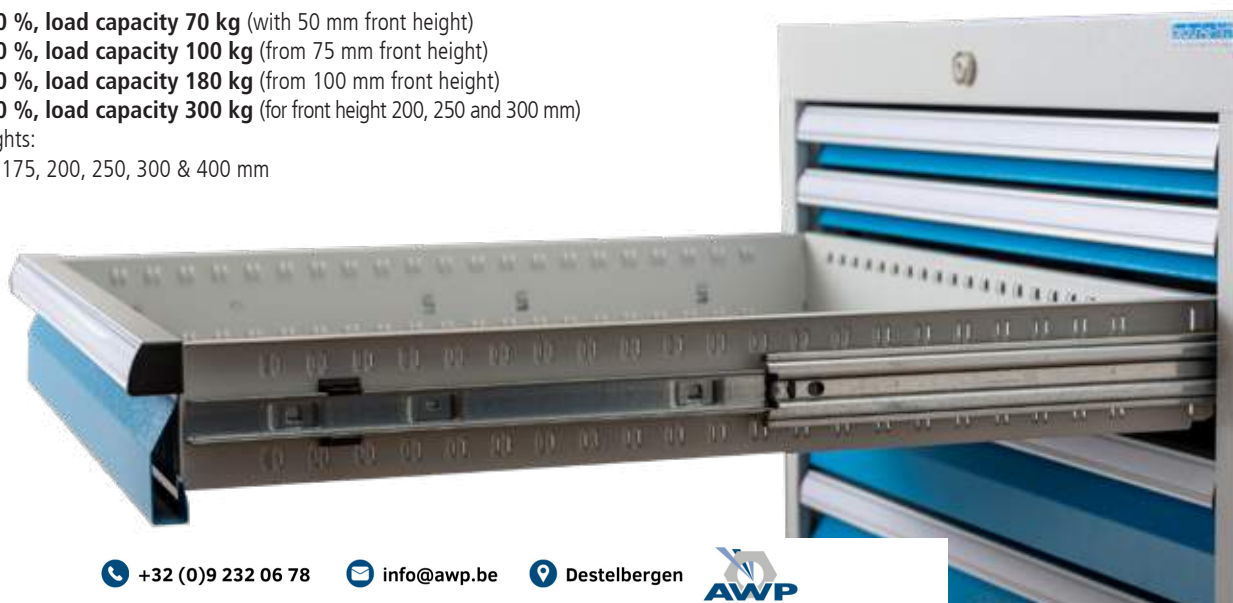

New heights



Series	Series	Series	Series
T736	T736	T736	T736

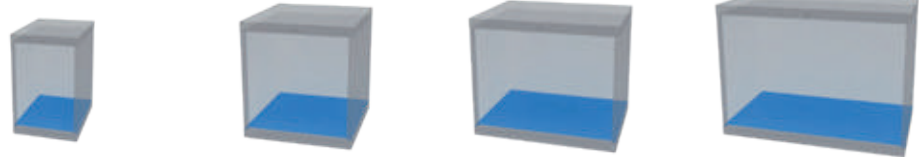

Housing height	Housing W x D	Housing W x D	Housing W x D	Housing W x D
	555 x 736	705 x 736	1005 x 736	1305 x 736
	Usable heights	Usable heights	Usable heights	Usable heights
519	400	400	400	–
619	500	500	500	–
719	600	600	600	–
819	700	700	700	700
919	800	800	800	800
1019	900	900	900	900
1119	1000	1000	1000	1000
1219	1100	1100	1100	1100
1319	1200	1200	1200	1200
1419	1300	13000	1300	1300
1519	1400	1400	1400	1400



Front height	Shell height	Drawer W x D	Drawer W x D	Drawer W x D	Drawer W x D
		450 x 600	600 x 600	900 x 600	1200 x 600
		Load capacity	Load capacity	Load capacity	Load capacity
50	28	70 kg	70 kg	70 kg	–
75	56	100 kg	100 kg	100 kg	100 kg
100	81	100 / 180 kg	100 / 180 kg	100 / 180 kg	180 kg
125	81	100 / 180 kg	100 / 180 kg	100 / 180 kg	180 kg
150	131	100 / 180 kg	100 / 180 kg	100 / 180 kg	180 kg
175	131	100 / 180 kg	100 / 180 kg	100 / 180 kg	180 kg
200	181	100 / 180 / 300 kg	100 / 180 / 300 kg	100 / 180 / 300 kg	180 kg
250	181	100 / 180 / 300 kg	100 / 180 / 300 kg	100 / 180 / 300 kg	180 kg
300	181	100 / 180 / 300 kg	100 / 180 / 300 kg	100 / 180 / 300 kg	–
400	81	100 / 180 kg	100 / 180 kg	100 / 180 kg	–



Series	Series	Series	Series
T736	T736	T736	T736
T736 18-24	T736 24-24	T736 36-24	T736 48-24
Grid:	R 18-24	R 24-24	R 36-24

All dimensions in mm

Grid: R 12-14 R 24-12 R 12-16 R 18-16 R 24-16 R 36-16 **R 18-24** R 24-24 R 36-24 R 48-24



Usable height 400 to 1400 mm
 Example:
 Usable height 400 mm
 Item no.
 0550

Number of drawers (front height)
 Example:
 3 drawers
 Usable height 400 mm

Complete order example:
 Item no.
 0550+
 2x 60.50.100V10
 1x 60.50.200V10

Housing including locking system, cylinder lock and two keys

New heights

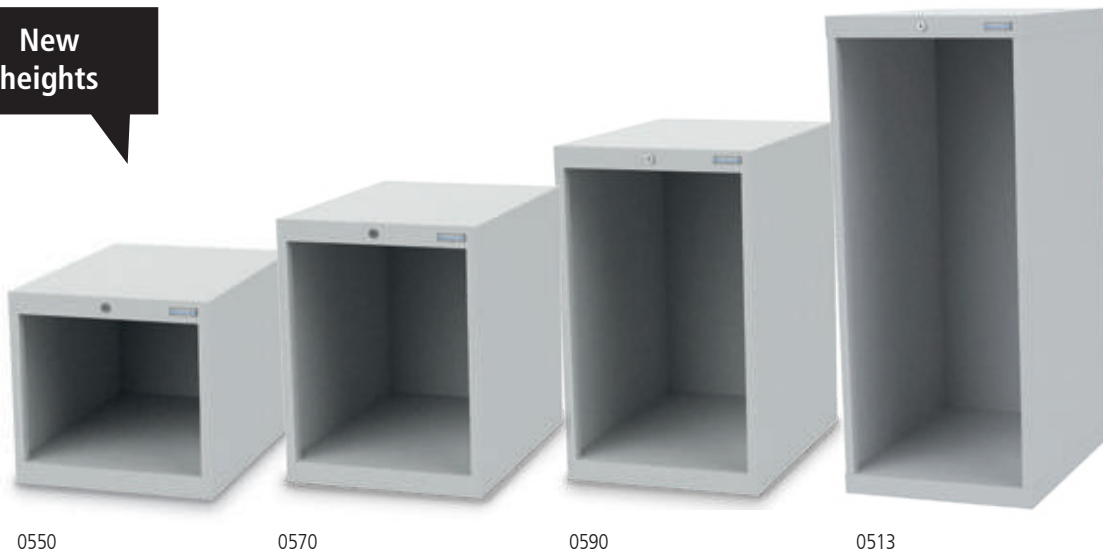

0550

0570

0590

0513

Total height = usable height + 119 mm

Item no.	Dimensions in mm (WxDxH)	Usable height in mm
0550	555 x 736 x 519	400
0560	555 x 736 x 619	500
0570	555 x 736 x 719	600
0580	555 x 736 x 819	700
0590	555 x 736 x 919	800
0500	555 x 736 x 1019	900
0511	555 x 736 x 1119	1000
0512	555 x 736 x 1219	1100
0513	555 x 736 x 1319	1200
0514	555 x 736 x 1419	1300
0515	555 x 736 x 1519	1400



Please visit our drawer cabinet configurator
www.bedrunka-hirth.de



Drawers R 18-24 incl. rails



450 x 600 mm (W x D) with full pull-out 100 % - 70/100 kg

Item no.	Front height	Shell height	Usable height	Load capacity
60.50.050V07	50	28	30	70 kg
60.50.075V10	75	56	58	100 kg
60.50.100V10	100	81	83	100 kg
60.50.125V10	125	81	108	100 kg
60.50.150V10	150	131	133	100 kg
60.50.175V10	175	131	158	100 kg
60.50.200V10	200	181	183	100 kg
60.50.250V10	250	181	233	100 kg
60.50.300V10	300	181	283	100 kg



450 x 600 mm (W x D) with full pull-out 100 % - 180 kg

Item no.	Front height	Shell height	Usable height	Load capacity
60.50.100V18	100	81	83	180 kg
60.50.125V18	125	81	108	180 kg
60.50.150V18	150	131	133	180 kg
60.50.175V18	175	131	158	180 kg
60.50.200V18	200	181	183	180 kg
60.50.250V18	250	181	233	180 kg
60.50.300V18	300	181	283	180 kg
60.50.30V18CNC	300	81	283	180 kg
60.50.40V18CNC	400	81	383	180 kg



450 x 600 mm (W x D) with full pull-out 100 % - 300 kg

Item no.	Front height	Shell height	Usable height	Load capacity
60.50.200V30	200	181	183	300 kg
60.50.250V30	250	181	233	300 kg
60.50.300V30	300	181	283	300 kg

Grid: R 12-14 R 24-12 R 12-16 R 18-16 R 24-16 R 36-16 **R 18-24** R 24-24 R 36-24 R 48-24

555 x 736 x 519 mm (W x D x H)

- Welded sheet steel construction
- Housing: powder-coated
- Central locking
- Drawers with full pull-out (FP) 100%
- Drawers with 50 mm front height, load capacity 70 kg
Drawers from 75 mm front height, load capacity 100 kg
- Drawer guides on ball-bearings
- Individual pull-out lock
- Individual locking per drawer possible
- Handle bars with insertable labelling strip
- Drawer front height: 50, 75, 100, 125, 150, 175, 200, 250, 300, 400 mm
- Usable drawer dimension: 450 x 600 mm
- Individual arrangements with 180 and 300 kg load capacity see page 70/71



Drawer soft close

- Possible from front height 75 mm
- When placing your order, please indicate the desired number of drawers with soft close.
- The specified price is understood as a surcharge per drawer.
- Retrofitting on existing drawers is not possible.
- Please note!** When opening the drawer, it must stay open for at least 5 seconds because of the soft close cylinder; otherwise the soft close mechanism will be damaged. Perfect functioning is then no longer guaranteed.

Item no.	Use from FH/load capacity
60.100.SC	75 mm - 100 kg



2x drawer

Item no.
550/0002V10



3x drawer

Item no.
550/0201V10



4x drawer

Item no.
550/1210V10



4x drawer

Item no.
550/0400V10



5x drawer

Item no.
550/3110V10



5x drawer

Item no.
550/12200V10

555 x 736 x 819 mm (W x D x H)

- Welded sheet steel construction
- Housing: powder-coated
- Central locking
- Drawers with full pull-out (FP) 100%
- Drawers with 50 mm front height, load capacity 70 kg
Drawers from 75 mm front height, load capacity 100 kg
- Drawer guides on ball-bearings
- Individual pull-out lock
- Individual locking per drawer possible
- Handle bars with insertable labelling strip
- Drawer front height: 50, 75, 100, 125, 150, 175, 200, 250, 300, 400 mm
- Usable drawer dimension: 450 x 600 mm
- Individual arrangements with 180 and 300 kg load capacity see page 70/71



Pin-Code

RFID

Equip your drawer cabinet with an E-lock. More information can be found on page 110



Suitable divider material can be found on page 75



▪ 6x drawer

Item no.
580/0501V10



▪ 7x drawer

Item no.
580/1222V10



▪ 7x drawer

Item no.
580/22111V10



▪ 8x drawer

Item no.
580/3410V10



▪ 8x drawer

Item no.
580/2600V10



▪ 8x drawer

Item no.
580/32201V10

Grid: R 12-14 R 24-12 R 12-16 R 18-16 R 24-16 R 36-16 **R 18-24** R 24-24 R 36-24 R 48-24

555 x 736 x 1019 mm (W x D x H)

- Welded sheet steel construction
- Housing: powder-coated
- Central locking
- Drawers with full pull-out (FP) 100%
- Drawers with 50 mm front height, load capacity 70 kg
Drawers from 75 mm front height, load capacity 100 kg
- Drawer guides on ball-bearings
- Individual pull-out lock
- Individual locking per drawer possible
- Handle bars with insertable labelling strip
- Drawer front height: 50, 75, 100, 125, 150, 175, 200, 250, 300, 400 mm
- Usable drawer dimension: 450 x 600 mm
- Individual arrangements with 180 and 300 kg load capacity see page 70/71



Drawer soft close

- Possible from front height 75 mm
- When placing your order, please indicate the desired number of drawers with soft close.
- The specified price is understood as a surcharge per drawer.
- Retrofitting on existing drawers is not possible.
- **Please note!** When opening the drawer, it must stay open for at least 5 seconds because of the soft close cylinder; otherwise the soft close mechanism will be damaged. Perfect functioning is then no longer guaranteed.

Item no.	Use from FH/load capacity
60.100.SC	75 mm - 100 kg



■ 7x drawer

Item no.
500/1222V10



■ 7x drawer

Item no.
500/1231V10



■ 8x drawer

Item no.
500/3131V10



■ 8x drawer

Item no.
500/1223V10



■ 9x drawer

Item no.
500/0900V10



■ 9x drawer

Item no.
500/4302V10



Drawer inserts | ABS

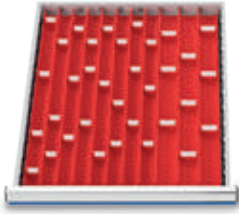

Trough plates | 46 parts

- 8x TP with 4 troughs
- 4x TP with 3 troughs
- 25x SDIV for 4 troughs
- 9x SDIV for 3 troughs

Item no.	Front height in mm
111	50/75

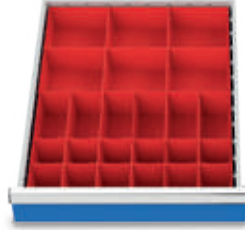

Small parts boxes | 24 parts

- 6x SPB 150 x 150 mm
- 6x SPB 75 x 150 mm
- 12x SPB 75 x 75 mm

Item no.	Front height in mm
112BLH50	50
112BLH75	75
112BLH100	100

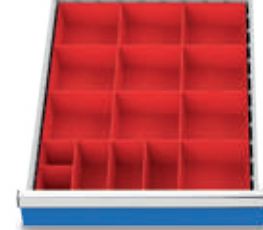

Small parts boxes | 15 parts

- 10x SPB 150 x 150 mm
- 3x SPB 75 x 150 mm
- 2x SPB 75 x 75 mm

Item no.	Front height in mm
119BLH50	50
119BLH75	75
119BLH100	100

Metal divider | galvanised sheet steel

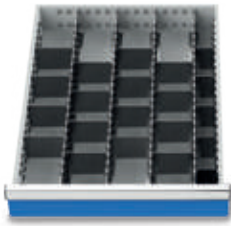

Metal divider | 25 parts

- 4x CCR 600 mm
- 5x DIV 50 mm
- 16x DIV 100 mm

Item no.	Front height in mm
110BLH50	50
110BLH75	75
110BLH100	100/125
110BLH150	150/175

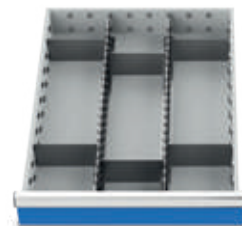

Metal divider | 8 parts

- 2x CCR 600 mm
- 6x DIV 150 mm

Item no.	Front height in mm
113BLH50	50
113BLH75	75
113BLH100	100/125
113BLH150	150/175
113BLH200	200/250/300

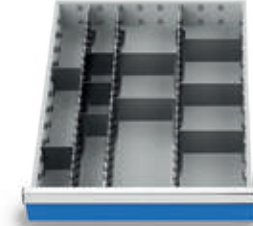

Metal divider | 13 parts

- 3x CCR 600 mm
- 5x DIV 75 mm
- 5x DIV 150 mm

Item no.	Front height in mm
114BLH50	50
114BLH75	75
114BLH100	100/125
114BLH150	150/175

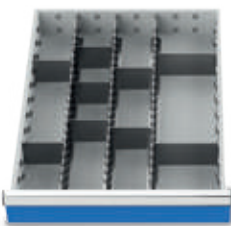

Metal divider | 12 parts

- 3x CCR 600 mm
- 7x DIV 100 mm
- 2x DIV 150 mm

Item no.	Front height in mm
116BLH50	50
116BLH75	75
116BLH100	100/125
116BLH150	150/175
116BLH200	200/250/300

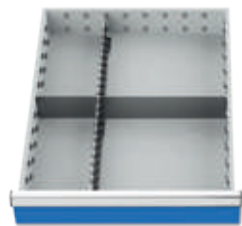

Metal divider | 3 parts

- 1x CCR 600 mm
- 1x DIV 150 mm
- 1x DIV 300 mm

Item no.	Front height in mm
115BLH75	75
115BLH100	100/125
115BLH150	150/175
115BLH200	200/250/300

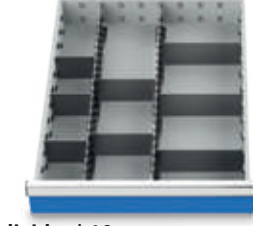

Metal divider | 10 parts

- 2x CCR 600 mm
- 3x DIV 100 mm
- 2x DIV 150 mm
- 3x DIV 200 mm

Item no.	Front height in mm
117BLH50	50
117BLH75	75
117BLH100	100/125
117BLH150	150/175
117BLH200	200/250/300

CCR = Centre compartment rails, DIV = Divider, SPB = Small Parts Box, TP = Trough Plate, SDIV = Slot-in divider

Grid: R 12-14 R 24-12 R 12-16 R 18-16 R 24-16 R 36-16 R 18-24 **R 24-24** R 36-24 R 48-24

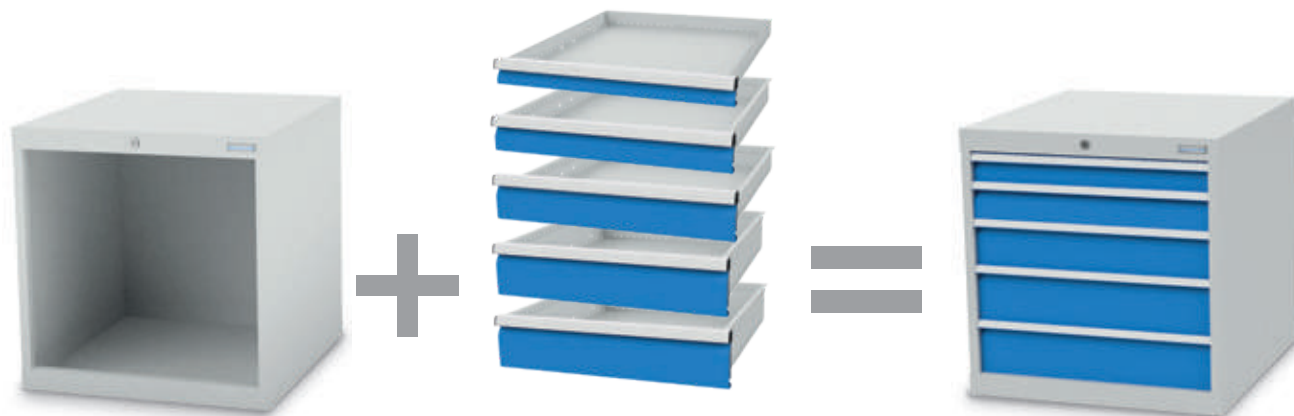

Usable height 300 to 1400 mm
 Example:
 Usable height 600 mm
 Item no. 0770

Number of drawers (front height)
 Example:
 5 drawers
 Usable height 600 mm

Complete order example:
 Item no.
 0770 +
 1x 60.70.075V10
 1x 60.70.100V10
 1x 60.70.125V10
 2x 60.70.150V10

Housing including locking system, cylinder lock and two keys

New heights

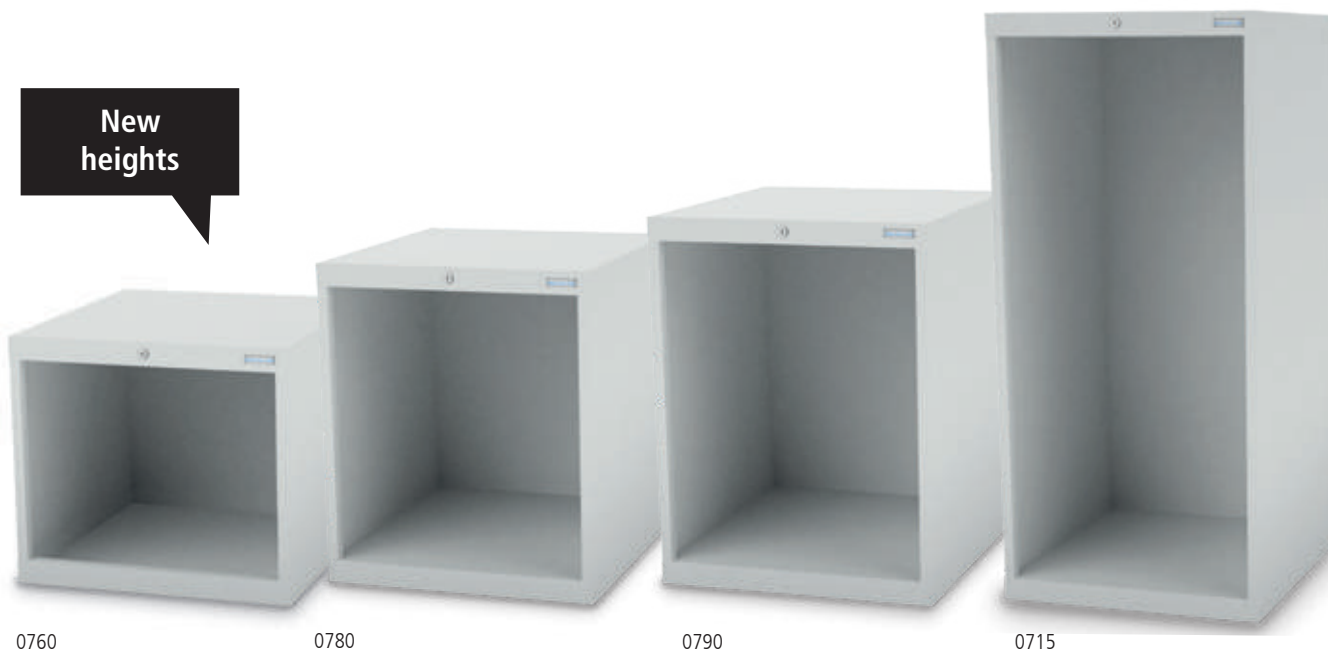

Total height = usable height + 119 mm

Item no.	Dimensions in mm (WxDxH)	Usable height in mm
0750	705 x 736 x 519	400
0760	705 x 736 x 619	500
0770	705 x 736 x 719	600
0780	705 x 736 x 819	700
0790	705 x 736 x 919	800
0700	705 x 736 x 1019	900
0711	705 x 736 x 1119	1000
0712	705 x 736 x 1219	1100
0713	705 x 736 x 1319	1200
0714	705 x 736 x 1419	1300
0715	705 x 736 x 1519	1400



Please visit our drawer cabinet configurator
www.bedrunka-hirth.de



Drawers R 24-24 incl. rails

600 x 600 mm (W x D) with full pull-out 100 % - 70/100 kg



Item no.	Front height	Shell height	Usable height	Load capacity
60.70.050V07	50	28	30	70 kg
60.70.075V10	75	56	58	100 kg
60.70.100V10	100	81	83	100 kg
60.70.125V10	125	81	108	100 kg
60.70.150V10	150	131	133	100 kg
60.70.175V10	175	131	158	100 kg
60.70.200V10	200	181	183	100 kg
60.70.250V10	250	181	233	100 kg
60.70.300V10	300	181	283	100 kg

600 x 600 mm (W x D) with full pull-out 100 % - 180 kg



Item no.	Front height	Shell height	Usable height	Load capacity
60.70.100V18	100	81	83	180 kg
60.70.125V18	125	81	108	180 kg
60.70.150V18	150	131	133	180 kg
60.70.175V18	175	131	158	180 kg
60.70.200V18	200	181	183	180 kg
60.70.250V18	250	181	233	180 kg
60.70.300V18	300	181	283	180 kg
60.70.30V18CNC	300	81	283	180 kg
60.70.40V18CNC	400	81	383	180 kg

600 x 600 mm (W x D) with full pull-out 100 % - 300 kg



Item no.	Front height	Shell height	Usable height	Load capacity
60.70.200V30	200	181	183	300 kg
60.70.250V30	250	181	233	300 kg
60.70.300V30	300	181	283	300 kg

Grid: R 12-14 R 24-12 R 12-16 R 18-16 R 24-16 R 36-16 R 18-24 **R 24-24** R 36-24 R 48-24

705 x 736 x 719 mm (W x D x H)

- Welded sheet steel construction
- Housing: powder-coated
- Central locking
- Drawers with full pull-out (FP) 100%
- Drawers with 50 mm front height, load capacity 70 kg
Drawers from 75 mm front height, load capacity 100 kg
- Drawer guides on ball-bearings
- Individual pull-out lock
- Individual locking per drawer possible
- Handle bars with insertable labelling strip
- Drawer front height: 50, 75, 100, 125, 150, 175, 200, 250, 300, 400 mm
- Usable drawer dimension: 600 x 600 mm
- Individual arrangements with 180 and 300 kg load capacity see page 76/77



Drawer soft close

- Possible from front height 75 mm
- When placing your order, please indicate the desired number of drawers with soft close.
- The specified price is understood as a surcharge per drawer.
- Retrofitting on existing drawers is not possible.
- Please note!** When opening the drawer, it must stay open for at least 5 seconds because of the soft close cylinder; otherwise the soft close mechanism will be damaged. Perfect functioning is then no longer guaranteed.

Item no.	Use from FH/load capacity
60.100.SC	75 mm - 100 kg



- 4x drawer

Item no.
770/0121V10



- 4x drawer

Item no.
770/0040V10



- 5x drawer

Item no.
770/0320V10



- 5x drawer

Item no.
770/1112V10



- 6x drawer

Item no.
770/2220V10



- 6x drawer

Item no.
770/0600V10

705 x 736 x 819 mm (W x D x H)

- Welded sheet steel construction
- Housing: powder-coated
- Central locking
- Drawers with full pull-out (FP) 100%
- Drawers with 50 mm front height, load capacity 70 kg
Drawers from 75 mm front height, load capacity 100 kg
- Drawer guides on ball-bearings
- Individual pull-out lock
- Individual locking per drawer possible
- Handle bars with insertable labelling strip
- Drawer front height: 50, 75, 100, 125, 150, 175, 200, 250, 300, 400 mm
- Usable drawer dimension: 600 x 600 mm
- Individual arrangements with 180 and 300 kg load capacity see page 76/77



Pin-Code

RFID

Equip your drawer cabinet with an E-lock. More information can be found on page 110



Suitable divider material can be found on page 83



■ 6x drawer

Item no.
780/0420V10



■ 6x drawer

Item no.
780/2121V10



■ 6x drawer

Item no.
780/1311V10



■ 7x drawer

Item no.
780/1222V10



■ 8x drawer

Item no.
780/4220V10



■ 8x drawer

Item no.
780/3221V10

Grid: R 12-14 R 24-12 R 12-16 R 18-16 R 24-16 R 36-16 R 18-24 **R 24-24** R 36-24 R 48-24

705 x 736 x 1019 mm (W x D x H)

- Welded sheet steel construction
- Housing: powder-coated
- Central locking
- Drawers with full pull-out (FP) 100%
- Drawers with 50 mm front height, load capacity 70 kg
Drawers from 75 mm front height, load capacity 100 kg
- Drawer guides on ball-bearings
- Individual pull-out lock
- Individual locking per drawer possible
- Handle bars with insertable labelling strip
- Drawer front height: 50, 75, 100, 125, 150, 175, 200, 250, 300, 400 mm
- Usable drawer dimension: 600 x 600 mm
- Individual arrangements with 180 and 300 kg load capacity see page 76/77



Drawer soft close

- Possible from front height 75 mm
- When placing your order, please indicate the desired number of drawers with soft close.
- The specified price is understood as a surcharge per drawer.
- Retrofitting on existing drawers is not possible.
- Please note!** When opening the drawer, it must stay open for at least 5 seconds because of the soft close cylinder; otherwise the soft close mechanism will be damaged. Perfect functioning is then no longer guaranteed.

Item no.	Use from FH/load capacity
60.100.SC	75 mm - 100 kg



- 8x drawer

Item no.
700/4112V10



- 8x drawer

Item no.
700/2321V10



- 9x drawer

Item no.
700/3411V10



- 9x drawer

Item no.
700/2223V10



- 9x drawer

Item no.
700/4302V10



- 10x drawer

Item no.
700/4501V10

705 x 736 x 1319 mm (W x D x H)

- Welded sheet steel construction
- Housing: powder-coated
- Central locking
- Drawers with full pull-out (FP) 100%
- Drawers with 50 mm front height, load capacity 70 kg
Drawers from 75 mm front height, load capacity 100 kg
- Drawer guides on ball-bearings
- Individual pull-out lock
- Individual locking per drawer possible
- Handle bars with insertable labelling strip
- Drawer front height: 50, 75, 100, 125, 150, 175, 200, 250, 300, 400 mm
- Usable drawer dimension: 600 x 600 mm
- Individual arrangements with 180 and 300 kg load capacity see page 76/77



Suitable divider material can be found on page 83

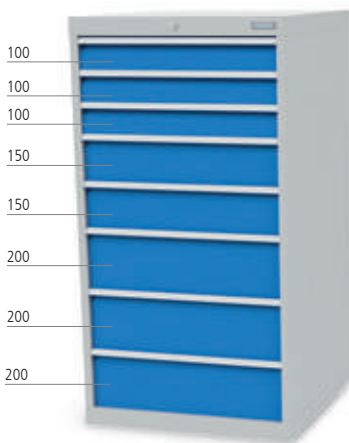

■ 8x drawer

Item no.
713/0323V10

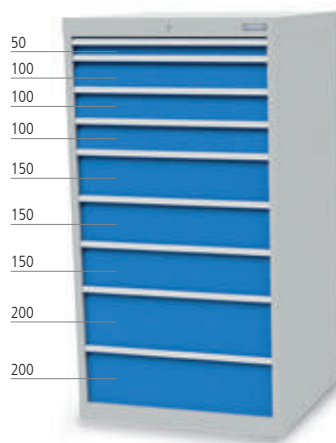

■ 9x drawer

Item no.
713/1332V10

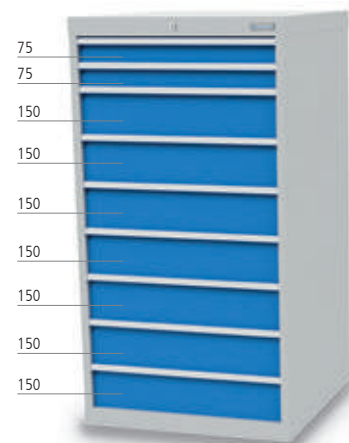

■ 9x drawer

Item no.
713/0270V10

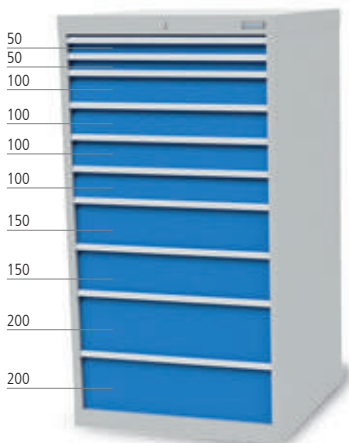

■ 10x drawer

Item no.
713/2422V10

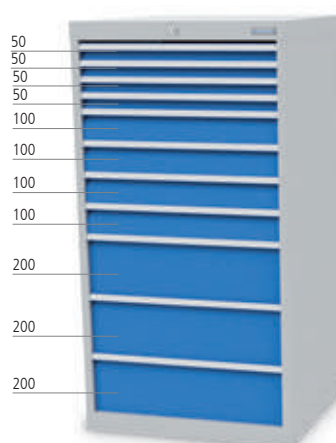

■ 11x drawer

Item no.
713/4403V10

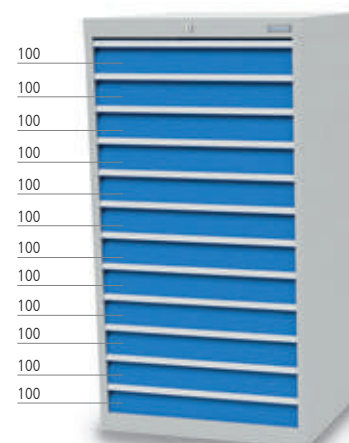

■ 12x drawer

Item no.
713/0120V10

Grid: R 12-14 R 24-12 R 12-16 R 18-16 R 24-16 R 36-16 R 18-24 **R 24-24** R 36-24 R 48-24

705 x 736 x 1519 mm (W x D x H)

- Welded sheet steel construction
- Housing: powder-coated
- Central locking
- Drawers with full pull-out (FP) 100%
- Drawers with 50 mm front height, load capacity 70 kg
Drawers from 75 mm front height, load capacity 100 kg
- Drawer guides on ball-bearings
- Individual pull-out lock
- Individual locking per drawer possible
- Handle bars with insertable labelling strip
- Drawer front height: 50, 75, 100, 125, 150, 175, 200, 250, 300, 400 mm
- Usable drawer dimension: 600 x 600 mm
- Individual arrangements with 180 and 300 kg load capacity
see page 76/77



Drawer soft close

- Possible from front height 75 mm
- When placing your order, please indicate the desired number of drawers with soft close.
- The specified price is understood as a surcharge per drawer.
- Retrofitting on existing drawers is not possible.
- Please note!** When opening the drawer, it must stay open for at least 5 seconds because of the soft close cylinder; otherwise the soft close mechanism will be damaged. Perfect functioning is then no longer guaranteed.

Item no.	Use from FH/load capacity
60.100.SC	75 mm - 100 kg

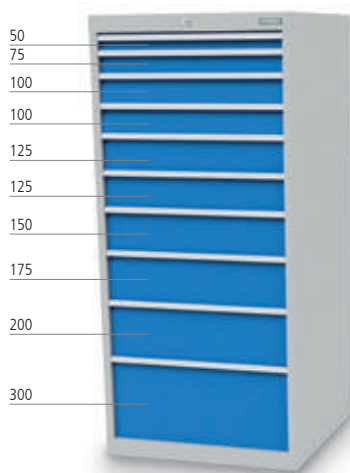

10x drawer

Item no.
715/0100V10

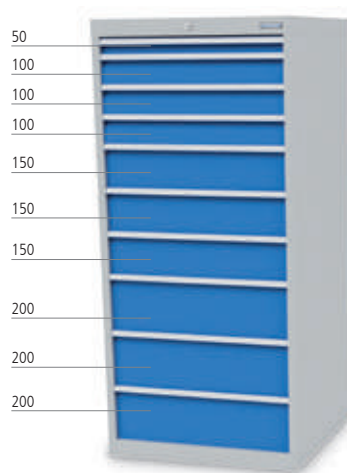

10x drawer

Item no.
715/1333V10

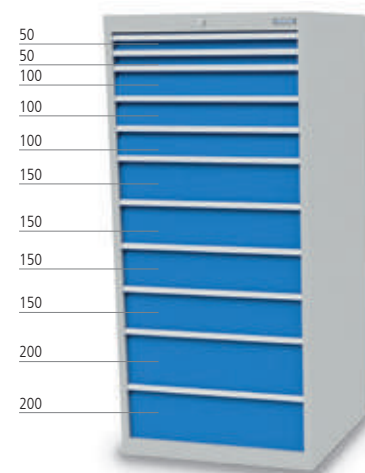

11x drawer

Item no.
715/2342V10

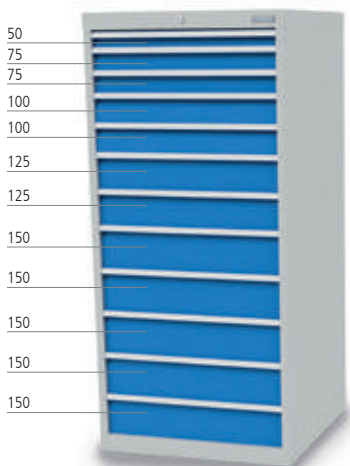

12x drawer

Item no.
715/0120V10

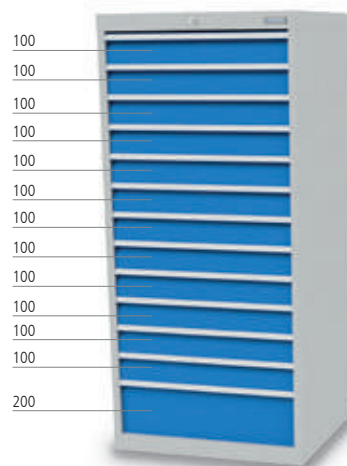

13x drawer

Item no.
715/0130V10

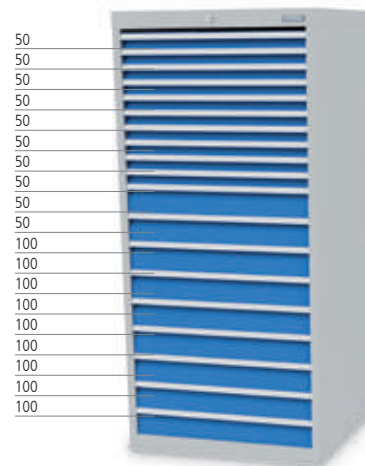

19x drawer

Item no.
715/1900V10

Drawer inserts | ABS

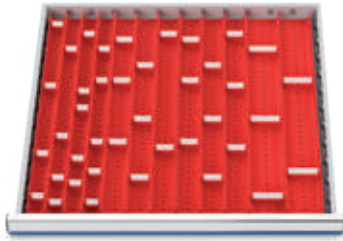

Trough plates | 56 parts

- 4x TP with 4 troughs
- 8x TP with 3 troughs
- 4x TP with 2 troughs
- 18x SDIV for 4 troughs
- 17x SDIV for 3 troughs
- 5x SDIV for 2 troughs

Item no.	Front height in mm
130	50/75



Small parts boxes | 32 parts

- 8x SPB 150 x 150 mm
- 8x SPB 75 x 150 mm
- 16x SPB 75 x 75 mm

Item no.	Front height in mm
132BLH50	50
132BLH75	75
132BLH100	100

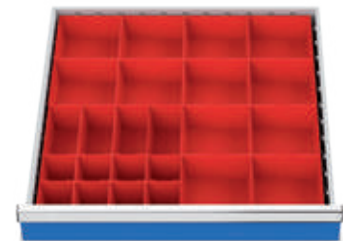

Small parts boxes | 24 parts

- 12x SPB 150 x 150 mm
- 4x SPB 75 x 150 mm
- 8x SPB 75 x 75 mm

Item no.	Front height in mm
134BLH50	50
134BLH75	75
134BLH100	100



Metal divider | 7 parts

- 2x CCR 600 mm
- 5x DIV 200 mm

Item no.	Front height in mm
135BLH50	50
135BLH75	75
135BLH100	100/125
135BLH150	150/175
135BLH200	200/250/300



Metal divider | 13 parts

- 3x CCR 600 mm
- 10x DIV 150 mm

Item no.	Front height in mm
138BLH50	50
138BLH75	75
138BLH100	100/125
138BLH150	150/175
138BLH200	200/250/300



Metal divider | 11 parts

- 2x CCR 600 mm
- 3x DIV 100 mm
- 3x DIV 200 mm
- 3x DIV 300 mm

Item no.	Front height in mm
147BLH75	75
147BLH100	100/125
147BLH150	150/175
147BLH200	200/250/300



Metal divider | 10 parts

- 2x CCR 600 mm
- 8x DIV 200 mm

Item no.	Front height in mm
139BLH50	50
139BLH75	75
139BLH100	100/125
139BLH150	150/175
139BLH200	200/250/300



Metal divider | 5 parts

- 1x CCR 600 mm
- 4x DIV 300 mm

Item no.	Front height in mm
144BLH75	75
144BLH100	100/125
144BLH150	150/175
144BLH200	200/250/300

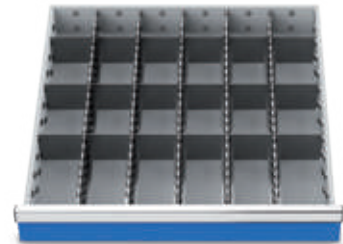

Metal divider | 23 parts

- 5x CCR 600 mm
- 18x DIV 100 mm

Item no.	Front height in mm
149BLH50	50
149BLH75	75
149BLH100	100/125
149BLH150	150/175
149BLH200	200/250/300

CCR = Centre compartment rails, DIV = Divider, SPB = Small Parts Box, TP = Trough Plate, SDIV = Slot-in divider

Grid: R 12-14 R 24-12 R 12-16 R 18-16 R 24-16 R 36-16 R 18-24 R 24-24 **R 36-24** R 48-24



Usable height 400 to 1400 mm
 Example:
 Usable height 600 mm
 Item no.
 1070

Number of drawers (front height)
 Example:
 5 drawers
 Usable height 600 mm

Complete order example:
 Item no.
 1050 +
 3x 60.10.100V10
 2x 60.10.150V10

Housing including locking system, cylinder lock and two keys

New heights



1070



1090

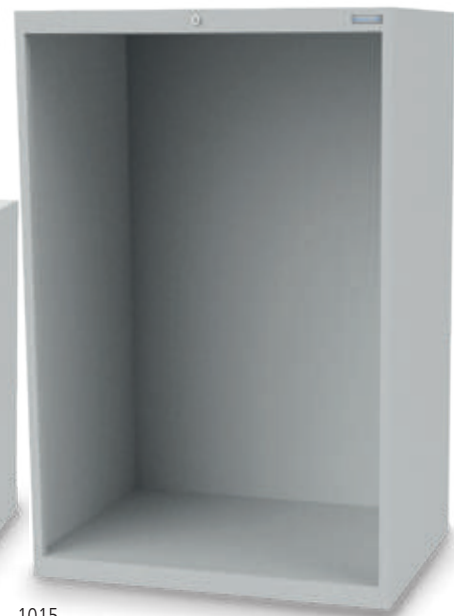

1015

Total height = usable height + 119 mm

Item no.	Dimensions in mm (WxDxH)	Usable height in mm
1050	1005 x 736 x 519	400
1060	1005 x 736 x 619	500
1070	1005 x 736 x 719	600
1080	1005 x 736 x 819	700
1090	1005 x 736 x 919	800
1000	1005 x 736 x 1019	900
1011	1005 x 736 x 1119	1000
1012	1005 x 736 x 1219	1100
1013	1005 x 736 x 1319	1200
1014	1005 x 736 x 1419	1300
1015	1005 x 736 x 1519	1400



Please visit our drawer cabinet configurator
www.bedrunka-hirth.de



Drawers R 36-24 incl. rails



900 x 600 mm (W x D) with full pull-out 100 % - 70/100 kg

Item no.	Front height	Shell height	Usable height	Load capacity
60.10.050V07	50	28	30	70 kg
60.10.075V10	75	56	58	100 kg
60.10.100V10	100	81	83	100 kg
60.10.125V10	125	81	108	100 kg
60.10.150V10	150	131	133	100 kg
60.10.175V10	175	131	158	100 kg
60.10.200V10	200	181	183	100 kg
60.10.250V10	250	181	233	100 kg
60.10.300V10	300	181	283	100 kg



900 x 600 mm (W x D) with full pull-out 100 % - 180 kg

Item no.	Front height	Shell height	Usable height	Load capacity
60.10.100V18	100	81	83	180 kg
60.10.125V18	125	81	108	180 kg
60.10.150V18	150	131	133	180 kg
60.10.175V18	175	131	158	180 kg
60.10.200V18	200	181	183	180 kg
60.10.250V18	250	181	233	180 kg
60.10.300V18	300	181	283	180 kg
60.10.30V18CNC	300	81	283	180 kg
60.10.40V18CNC	400	81	383	180 kg



900 x 600 mm (W x D) with full pull-out 100 % - 300 kg

Item no.	Front height	Shell height	Usable height	Load capacity
60.10.200V30	200	181	183	300 kg
60.10.250V30	250	181	233	300 kg
60.10.300V30	300	181	283	300 kg

id: R 12-14 R 24-12 R 12-16 R 18-16 R 24-16 R 36-16 R 18-24 R 24-24 **R 36-24** R 48-24

1005 x 736 x 719 mm (W x D x H)

- Welded sheet steel construction
- Housing: powder-coated
- Central locking
- Drawers with full pull-out (FP) 100%
- Drawers with 50 mm front height: load capacity 70 kg; drawers from 75 mm front height: load capacity 100 kg
- Drawer guides on ball-bearings
- Individual pull-out lock
- Individual locking per drawer possible
- Handle bars with insertable labelling strip
- Drawer front height: 50, 75, 100, 125, 150, 175, 200, 250, 300, 400 mm
- Usable drawer dimension: 900 x 600 mm
- Individual arrangements with 180 and 300 kg load capacity see page 84/85



Drawer soft close

- Possible from front height 75 mm
- When placing your order, please indicate the desired number of drawers with soft close.
- The specified price is understood as a surcharge per drawer.
- Retrofitting on existing drawers is not possible.
- Please note!** When opening the drawer, it must stay open for at least 5 seconds because of the soft close cylinder; otherwise the soft close mechanism will be damaged. Perfect functioning is then no longer guaranteed.

Item no.	Use from FH/load capacity
60.100.SC	75 mm - 100 kg



- 4x drawer

Item no.
170/0040V10



- 5x drawer

Item no.
170/0320V10



- 5x drawer

Item no.
170/1112V10



- 6x drawer

Item no.
170/2220V10



- 6x drawer

Item no.
170/0600V10



- 7x drawer

Item no.
170/4210V10

1005 x 736 x 819 mm (W x D x H)

- Welded sheet steel construction
- Housing: powder-coated
- Central locking
- Drawers with full pull-out (FP) 100%
- Drawers with 50 mm front height: load capacity 70 kg;
drawers from 75 mm front height: load capacity 100 kg
- Drawer guides on ball-bearings
- Individual pull-out lock
- Individual locking per drawer possible
- Handle bars with insertable labelling strip
- Drawer front height: 50, 75, 100, 125,
150, 175, 200, 250, 300, 400 mm
- Usable drawer dimension: 900 x 600 mm
- Individual arrangements with 180 and 300 kg load capacity
see page 84/85



Pin-Code

RFID

Equip your drawer cabinet with an E-lock. More information can be found on page 110



Suitable divider material can be found on page 91



■ 5x drawer

Item no.
180/0221V10



■ 6x drawer

Item no.
180/2040V10



■ 6x drawer

Item no.
180/2121V10



■ 7x drawer

Item no.
180/3211V10



■ 7x drawer

Item no.
180/22111V10



■ 8x drawer

Item no.
180/4310V10

Grid: R 12-14 R 24-12 R 12-16 R 18-16 R 24-16 R 36-16 R 18-24 R 24-24 **R 36-24** R 48-24

1005 x 736 x 1019 mm (W x D x H)

- Welded sheet steel construction
- Housing: powder-coated
- Central locking
- Drawers with full pull-out (FP) 100%
- Drawers with 50 mm front height: load capacity 70 kg; drawers from 75 mm front height: load capacity 100 kg
- Drawer guides on ball-bearings
- Individual pull-out lock
- Individual locking per drawer possible
- Handle bars with insertable labelling strip
- Drawer front height: 50, 75, 100, 125, 150, 175, 200, 250, 300, 400 mm
- Usable drawer dimension: 900 x 600 mm
- Individual arrangements with 180 and 300 kg load capacity see page 84/85



Drawer soft close

- Possible from front height 75 mm
- When placing your order, please indicate the desired number of drawers with soft close.
- The specified price is understood as a surcharge per drawer.
- Retrofitting on existing drawers is not possible.
- Please note!** When opening the drawer, it must stay open for at least 5 seconds because of the soft close cylinder; otherwise the soft close mechanism will be damaged. Perfect functioning is then no longer guaranteed.

Item no.	Use from FH/load capacity
60.100.SC	75 mm - 100 kg



6x drawer

Item no.
100/0213V10



7x drawer

Item no.
100/1231V10



8x drawer

Item no.
100/2141V10



9x drawer

Item no.
100/4221V10



9x drawer

Item no.
100/4311V10



10x drawer

Item no.
100/22510V10

1005 x 736 x 1319 mm (W x D x H)

- Welded sheet steel construction
- Housing: powder-coated
- Central locking
- Drawers with full pull-out (FP) 100%
- Drawers with 50 mm front height, load capacity 70 kg
Drawers from 75 mm front height, load capacity 100 kg
- Drawer guides on ball-bearings
- Individual pull-out lock
- Individual locking per drawer possible
- Handle bars with insertable labelling strip
- Drawer front height: 50, 75, 100, 125, 150, 175, 200, 250, 300, 400 mm
- Usable drawer dimension: 900 x 600 mm
- Individual arrangements with 180 and 300 kg load capacity see page 84/85



Pin-Code

RFID

Equip your drawer cabinet with an E-lock. More information can be found on page 110



Suitable divider material can be found on page 91



■ 8x drawer

Item no.
113/0323V10



■ 9x drawer

Item no.
113/2223V10

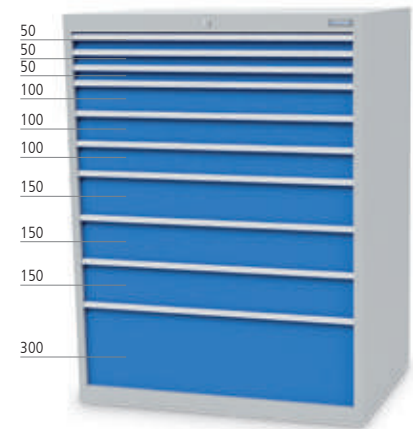

■ 10x drawer

Item no.
113/3331V10



■ 11x drawer

Item no.
113/22331V10



■ 11x drawer

Item no.
113/2423V10

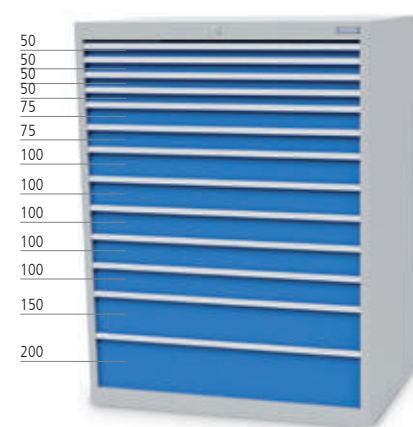

■ 13x drawer

Item no.
113/42511V10

Grid: R 12-14 R 24-12 R 12-16 R 18-16 R 24-16 R 36-16 R 18-24 R 24-24 **R 36-24** R 48-24

1005 x 736 x 1519 mm (W x D x H)

- Welded sheet steel construction
- Housing: powder-coated
- Central locking
- Drawers with full pull-out (FP) 100%
- Drawers with 50 mm front height, load capacity 70 kg
- Drawers from 75 mm front height, load capacity 100 kg
- Drawer guides on ball-bearings
- Individual pull-out lock
- Individual locking per drawer possible
- Handle bars with insertable labelling strip
- Drawer front height: 50, 75, 100, 125, 150, 175, 200, 250, 300, 400 mm
- Usable drawer dimension: 900 x 600 mm
- Individual arrangements with 180 and 300 kg load capacity see page 106/107



Drawer soft close

- Possible from front height 75 mm
- When placing your order, please indicate the desired number of drawers with soft close.
- The specified price is understood as a surcharge per drawer.
- Retrofitting on existing drawers is not possible.
- Please note!** When opening the drawer, it must stay open for at least 5 seconds because of the soft close cylinder; otherwise the soft close mechanism will be damaged. Perfect functioning is then no longer guaranteed.

Item no.	Use from FH/load capacity
60.100.SC	75 mm - 100 kg

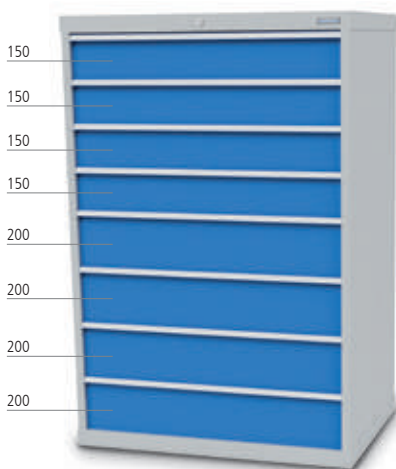

8x drawer

Item no.
115/0044V10

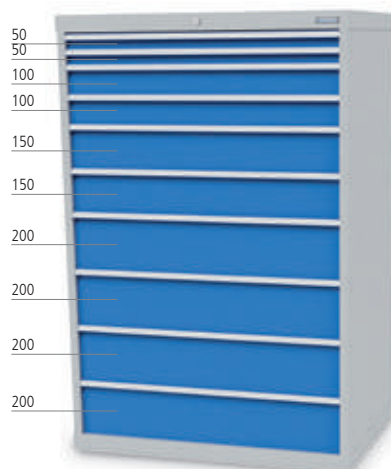

10x drawer

Item no.
115/2224V10

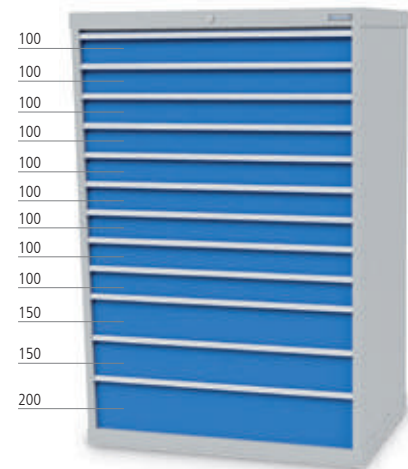

12x drawer

Item no.
115/0921V10

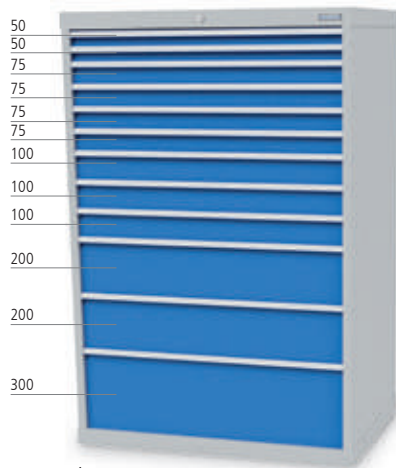

12x drawer

Item no.
115/24321V10

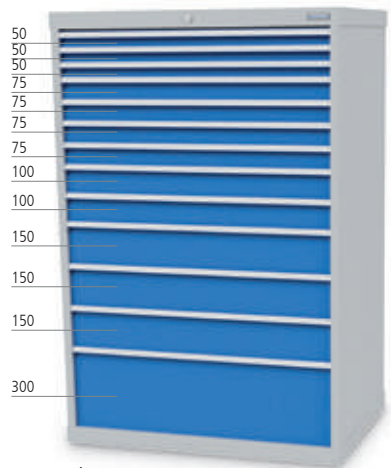

13x drawer

Item no.
115/34231V10

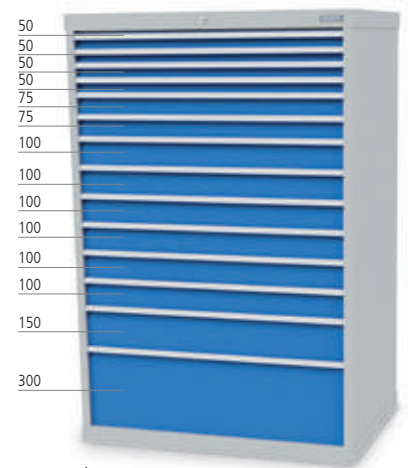

14x drawer

Item no.
115/42611V10

Drawer inserts | ABS

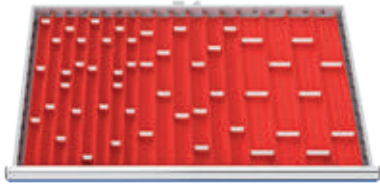

Trough plates | 71 parts

- 8x TP with 4 troughs
- 8x TP with 3 troughs
- 8x TP with 2 troughs
- 23x SDIV for 4 troughs
- 14x SDIV for 3 troughs
- 10x SDIV for 2 troughs

Item no.	Front height in mm
150	50/75



Small parts boxes | 40 parts

- 16x SPB 150 x 150 mm
- 8x SPB 75 x 150 mm
- 16x SPB 75 x 75 mm

Item no.	Front height in mm
159BLH50	50
159BLH75	75
159BLH100	100/125

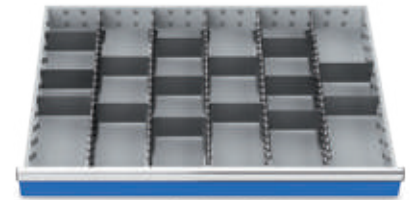

Metal divider | 20 parts

- 5x CCR 600 mm
- 15x DIV 150 mm

Item no.	Front height in mm
153BLH50	50
153BLH75	75
153BLH100	100/125
153BLH150	150/175
153BLH200	200/300



Metal divider | 5 parts

- 2x CCR 600 mm
- 3x DIV 300 mm

Item no.	Front height in mm
155BLH75	75
155BLH100	100/125
155BLH150	150/175
155BLH200	200/250/300



Metal divider | 24 parts

- 4x CCR 600 mm
- 16x DIV 150 mm
- 4x DIV 300 mm

Item no.	Front height in mm
171BLH75	75
171BLH100	100/125
171BLH150	150/175
171BLH200	200/250/300

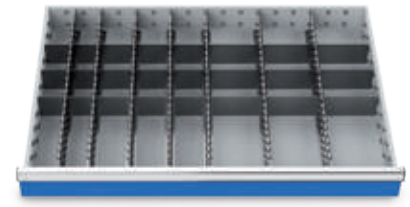

Metal divider | 31 parts

- 7x CCR 600 mm
- 6x DIV 75 mm
- 9x DIV 100 mm
- 9x DIV 150 mm

Item no.	Front height in mm
172BLH50	50
172BLH75	75
172BLH100	100/125
172BLH150	150/175
172BLH200	200/250/300

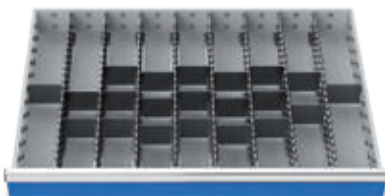

Metal divider | 29 parts

- 8x CCR 600 mm
- 21x DIV 100 mm

Item no.	Front height in mm
161BLH50	50
161BLH75	75
161BLH100	100/125
161BLH150	150/175
161BLH200	200/250/300



Metal divider | 10 parts

- 2x CCR 600 mm
- 8x DIV 300 mm

Item no.	Front height in mm
166BLH75	75
166BLH100	100/125
166BLH150	150/175
166BLH200	200/250/300

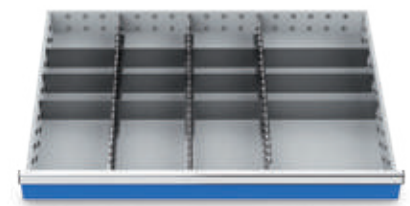

Metal divider | 15 parts

- 3x CCR 600 mm
- 9x DIV 200 mm
- 3x DIV 300 mm

Item no.	Front height in mm
170BLH75	75
170BLH100	100/125
170BLH150	150/175
170BLH200	200/250/300

CCR = Centre compartment rails, DIV = Divider, SPB = Small Parts Box, TP = Trough Plate, SDIV = Slot-in divider

Modular system

Grid: R 12-14 R 24-12 R 12-16 R 18-16 R 24-16 R 36-16 R 18-24 R 24-24 R 36-24 R 48-24

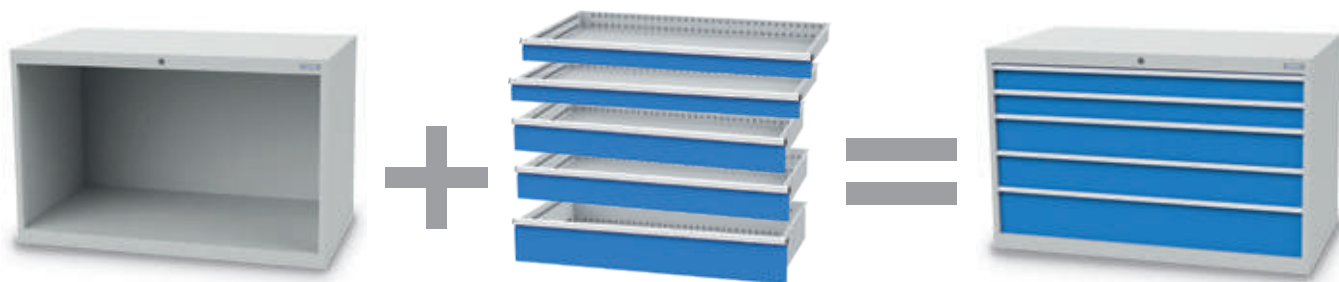

Usable height 700 to 1400 mm
 Example:
 Usable height 700 mm
 Item no. 1380

Number of drawers (front height)
 Example:
 5 drawers
 Usable height 700 mm

Complete order example:
 Item no.
 1380 +
 2x 60.13.100V18
 2x 60.13.150V18
 1x 60.13.200V18

Housing including locking system, cylinder lock and two keys

New heights



1380

1300

1313

Housing incl. cylinder lock

Total height = usable height + 119 mm

Item no.	Dimensions in mm (WxDxH)	Usable height in mm
1350	1305 x 736 x 519	400
1360	1305 x 736 x 619	500
1370	1305 x 736 x 719	600
1380	1305 x 736 x 819	700
1390	1305 x 736 x 919	800
1300	1305 x 736 x 1019	900
1311	1305 x 736 x 1119	1000
1312	1305 x 736 x 1219	1100
1313	1305 x 736 x 1319	1200
1314	1305 x 736 x 1419	1300
1315	1305 x 736 x 1519	1400



Drawers R 48-24 incl. rails



Width 1200 x 600 with full pull-out 100 %



Item no.	Front height	Shell height	Usable height	Load capacity
60.13.075V10	75	56	58	100 kg
60.13.100V18	100	81	83	180 kg
60.13.125V18	125	81	108	180 kg
60.13.150V18	150	131	133	180 kg
60.13.175V18	175	131	158	180 kg
60.13.200V18	200	181	183	180 kg
60.13.250V18	250	181	233	180 kg

Drawers with load capacity 300 kg on request.

Grid: R 12-14 R 24-12 R 12-16 R 18-16 R 24-16 R 36-16 R 18-24 R 24-24 R 36-24 **R 48-24**

1305 x 736 x 819 mm (W x D x H)

- Welded sheet steel construction
- Housing: powder-coated
- Central locking
- Drawers with full pull-out (FP) 100%
- Drawers with 75 mm front height: load capacity 100 kg; drawers from 100 mm front height: load capacity 180 kg
- Drawer guides on ball-bearings
- Individual pull-out lock
- Individual locking per drawer possible
- Handle bars with insertable labelling strip
- Drawer front height: 75, 100, 125, 150, 175, 200, 250 mm
- Usable drawer dimension: 1200 x 600 mm
- Individual arrangements with 180 kg load capacity see page 92/93



Drawer soft close

- Possible from front height 75 mm
- When placing your order, please indicate the desired number of drawers with soft close.
- The specified price is understood as a surcharge per drawer.
- Retrofitting on existing drawers is not possible.
- **Please note!** When opening the drawer, it must stay open for at least 5 seconds because of the soft close cylinder; otherwise the soft close mechanism will be damaged. Perfect functioning is then no longer guaranteed.

Item no.	Use from FH/load capacity
60.100.SC	75 mm - 100 kg



- 5x drawer

Item no.
1380/0221V18



- 6x drawer

Item no.
1380/0420V18



- 6x drawer

Item no.
1380/2211V18



- 7x drawer

Item no.
1380/0700V18

1305 x 736 x 1019 mm (W x D x H)

- Welded sheet steel construction
- Housing: powder-coated
- Central locking
- Drawers with full pull-out (FP) 100%
- Drawers with 75 mm front height, load capacity 100 kg
Drawers from 100 mm front height, load capacity 180 kg
- Drawer guides on ball-bearings
- Individual pull-out lock
- Individual locking per drawer possible
- Handle bars with insertable labelling strip
- Drawer front height: 75, 100, 125, 150, 175, 200, 250 mm
- Usable drawer dimension: 1200 x 600 mm
- Individual arrangements with 180 kg load capacity see page 92/93



Pin-Code

RFID

Equip your drawer cabinet with an E-lock. More information can be found on page 110



Suitable divider material can be found on page 87



■ 6x drawer

Item no.

1300/0222V18



■ 6x drawer

Item no.

1300/1122V18



■ 7x drawer

Item no.

1300/2131V18



■ 9x drawer

Item no.

1300/0900V18

Grid: R 12-14 R 24-12 R 12-16 R 18-16 R 24-16 R 36-16 R 18-24 R 24-24 R 36-24 **R 48-24**

1305 x 736 x 1319 mm (W x D x H)

- Welded sheet steel construction
- Housing: powder-coated
- Central locking
- Drawers with full pull-out (FP) 100%
- Drawers with 75 mm front height, load capacity 100 kg
Drawers from 100 mm front height, load capacity 180 kg
- Drawer guides on ball-bearings
- Individual pull-out lock
- Individual locking per drawer possible
- Handle bars with insertable labelling strip
- Drawer front height: 75, 100, 125, 150, 175, 200, 250 mm
- Usable drawer dimension: 1200 x 600 mm
- Individual arrangements with 180 kg load capacity see page 92/93



Drawer soft close

- Possible from front height 75 mm
- When placing your order, please indicate the desired number of drawers with soft close.
- The specified price is understood as a surcharge per drawer.
- Retrofitting on existing drawers is not possible.
- **Please note!** When opening the drawer, it must stay open for at least 5 seconds because of the soft close cylinder; otherwise the soft close mechanism will be damaged. Perfect functioning is then no longer guaranteed.

Item no.	Use from FH/load capacity
60.100.SC	75 mm - 100 kg



- 8 drawers

Item no.
1313/0323V18

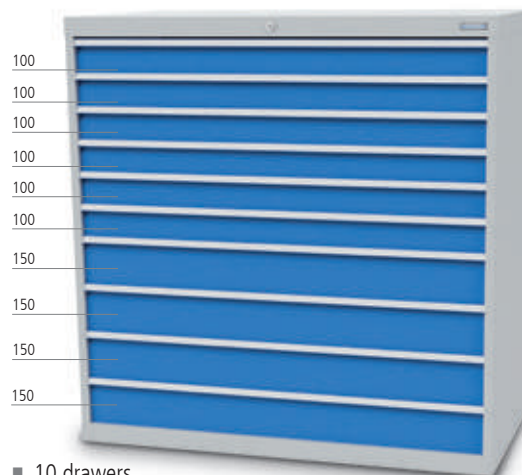

- 10 drawers

Item no.
1313/0640V18

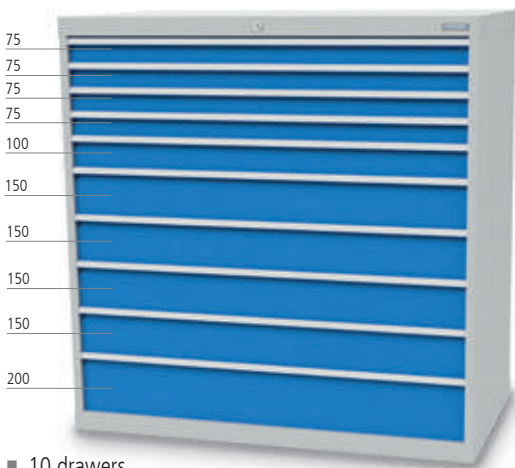

- 10 drawers

Item no.
1313/4141V18

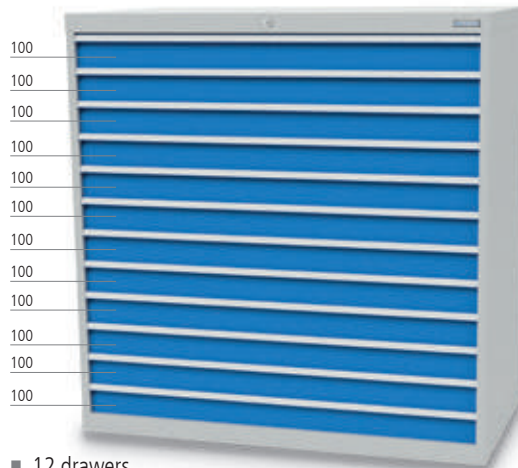

- 12 drawers

Item no.
1313/0120V18

Drawer inserts | ABS and galvanised sheet steel



Small parts boxes | 48 parts

- 16x SPB 150 x 150 mm
- 32x SPB 75 x 150 mm

Item no.	Front height in mm
182BLH75	75
182BLH100	100/125



Small parts boxes | 64 parts

- 16x SPB 150 x 150 mm
- 16x SPB 75 x 150 mm
- 32x SPB 75 x 75 mm

Item no.	Front height in mm
181BLH75	75
181BLH100	100/125

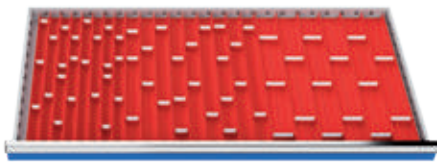

Trough plates | 91 parts

- 8x TP with 4 troughs
- 12x TP with 3 troughs
- 12x TP with 2 troughs
- 23x SDIV for 4 troughs
- 21x SDIV for 3 troughs
- 15x SDIV for 2 troughs

Item no.	Front height in mm
180BLH75	75

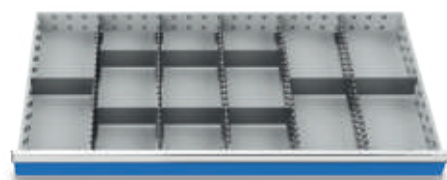

Metal divider | 14 parts

- 5x CCR 600 mm
- 9x DIV 200 mm

Item no.	Front height in mm
185BLH75	75
185BLH100	100/125
185BLH150	150
185BLH200	200/250

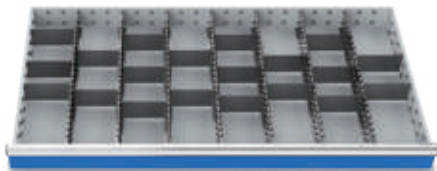

Metal divider | 27 parts

- 7x CCR 600 mm
- 20x DIV 150 mm

Item no.	Front height in mm
184BLH75	75
184BLH100	100/125
184BLH150	150
184BLH200	200/250



Metal divider | 27 parts

- 8x CCR 600 mm
- 4x DIV 200 mm
- 15x DIV 100 mm

Item no.	Front height in mm
183BLH75	75
183BLH100	100/125
183BLH150	150
183BLH200	200/250

CCR = Centre compartment rails, DIV = Divider, SPB = Small Parts Box, TP = Trough Plate, SDIV = Slot-in divider

Insertable labelling strip

- Fold up transparent panel and insert label. Press panel down again.
- Labelling strip and transparent cover kit
- Height 20 mm

Item no.	Designation
01.050.007-1	R 18-24
01.070.007-1	R 24-24
01.100.007-1	R 36-24
01.130.007-1	R 48-24



Divider elements, galvanised sheet steel

- Metal divider elements made from galvanised high-quality sheet metal
- Fine subdivision on the grid 25:25 mm

Metal divider, to be fixed between the drawer side and a slotted through or between 2 slotted throughs

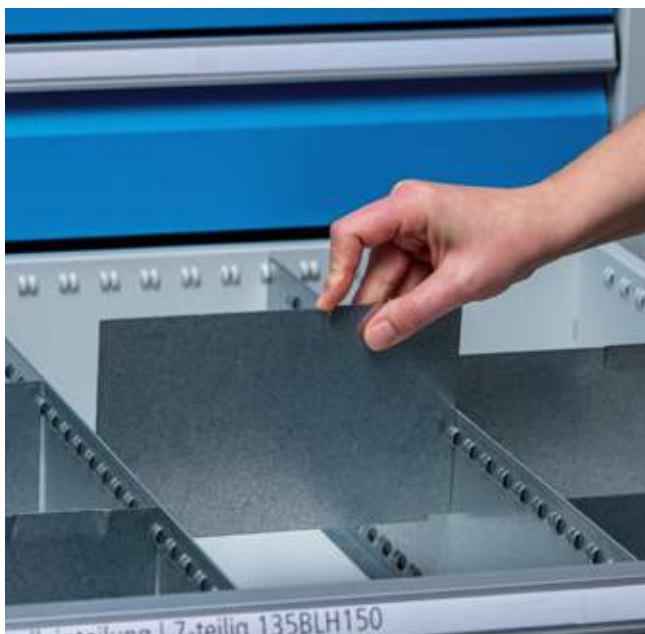

Centre compartment rail

Item no.	Front in mm	WxD in mm
20.600.030	50	600 x 30
20.600.050	75	600 x 50
20.600.075	100	600 x 75
20.600.125	150	600 x 125
20.600.175	200-300	600 x 175



Divider

- Front 50 mm



Item no.	WxD in mm
30.050.30	50 x 30
30.075.30	75 x 30
30.100.30	100 x 30
30.150.30	150 x 30
30.200.30	200 x 30
30.225.30	225 x 30
30.300.30	300 x 30



Divider

- Front 75 mm

Item no.	WxD in mm
30.050.050	50 x 50
30.075.050	75 x 50
30.100.050	100 x 50
30.150.050	150 x 50
30.200.050	200 x 50
30.225.050	225 x 50
30.300.050	300 x 50



Divider

- Front 100 mm

Item no.	WxD in mm
30.050.075	50 x 75
30.075.075	75 x 75
30.100.075	100 x 75
30.150.075	150 x 75
30.200.075	200 x 75
30.225.075	225 x 75
30.300.075	300 x 75



Divider

- Front 150 mm

Item no.	WxD in mm
30.050.125	50 x 125
30.075.125	75 x 125
30.100.125	100 x 125
30.150.125	150 x 125
30.200.125	200 x 125
30.225.125	225 x 125
30.250.125	250 x 125
30.300.125	300 x 125



Divider

- Front 200, 250, 300 mm

Item no.	WxD in mm
30.075.175	75 x 175
30.100.175	100 x 175
30.125.175	125 x 175
30.150.175	150 x 175
30.200.175	200 x 175
30.225.175	225 x 175
30.250.175	250 x 175
30.300.175	300 x 175
30.400.175	400 x 175

Other sizes on request

MDF tool boards

- With the tool boards, you create order and a clear overview when storage of your tools.
- Quickly to hand and sorted according to size, the MDF tool boards make work easier.
- Ready for use with cabinet widths 555, 705 and 1005 mm.
- Possible for the following drawer front heights 100, 150, 200, 250, 300 mm
- Tool boards available in MDF (medium density fibreboard) In two synthetic resin decor coatings; white and walnut
- Due to the upright storage in the individual tool places, damage to expensive carbide milling tools is avoided
- No unprotected tool cutting edges lying next to each other
- Special solutions, as well as individually manufactured solutions possible
- Examples: Compression and tension collets, holders for eroding machines erosion machines, turning steels, workpiece clamping devices, hand tools, measuring equipment!



Upon submission of an original sample, additional shapes can be produced individually.

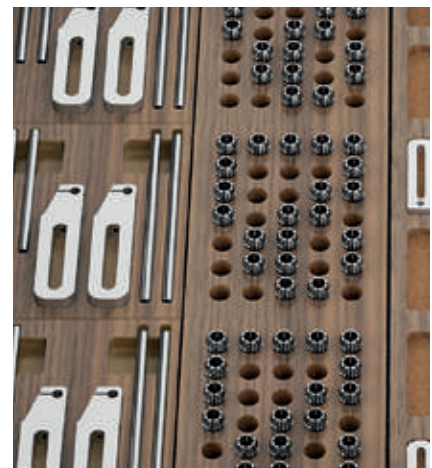
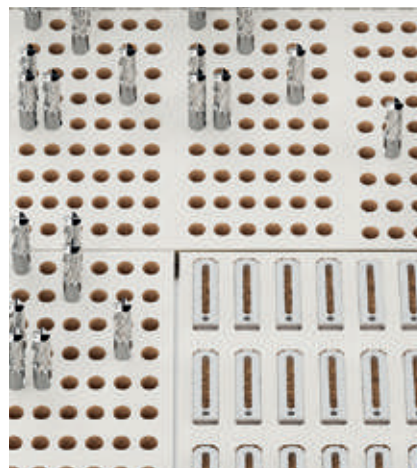

Individual equipment T736 series

**Hinged doors | cabinet width 555 und 705 mm, hinge left**

- Hinged doors with twist lock cylinder lock and 2 keys

Item no.	Grid	Design	for usable height
01.050.700EL	R 18-24	one door	700 mm
01.070.700EL	R 24-24	one door	700 mm
01.050.800EL	R 18-24	one door	800 mm
01.070.800EL	R 24-24	one door	800 mm
01.050.900EL	R 18-24	one door	900 mm
01.070.900EL	R 24-24	one door	900 mm

Hinged doors | cabinet width 555 und 705 mm, hinge right

- Hinged doors with twist lock cylinder lock and 2 keys

Item no.	Grid	Design	for usable height
01.050.700ER	R 18-24	one door	700 mm
01.070.700ER	R 24-24	one door	700 mm
01.050.800ER	R 18-24	one door	800 mm
01.070.800ER	R 24-24	one door	800 mm
01.050.900ER	R 18-24	one door	900 mm
01.070.900ER	R 24-24	one door	900 mm

Double doors | cabinet width 1005 mm

- Hinged doors with twist lock cylinder lock and 2 keys

Item no.	Grid	Design	for usable height
01.100.700E	R 36-24	two doors	700 mm
01.100.800E	R 36-24	two doors	800 mm
01.100.900E	R 36-24	two doors	900 mm

Double doors | cabinet width 1305 mm

- Hinged doors with twist lock cylinder lock and 2 keys

Item no.	Grid	Design	for usable height
01.130.700E	R 48-24	two doors	700 mm
01.130.800E	R 48-24	two doors	800 mm
01.130.900E	R 48-24	two doors	900 mm

Metal cover upon double doors vor cabinet width 1005 and 1305 mm

- For a cabinet with drawers on top and doors below a metal cover will be fixed upon the doors.
- The using height is reduced by 100 mm

Item no.	Grid
01.100.BLFL	R 36-24
01.130.BLFL	R 48-24



Ribbed rubber mat on cabinet

- Oil-proof

Item no.	Dimensions in mm (WxDxH)
65.050.730	555 x 736 x 3
65.070.730	705 x 736 x 3
65.100.730	1005 x 736 x 3
65.130.730	1305 x 736 x 3

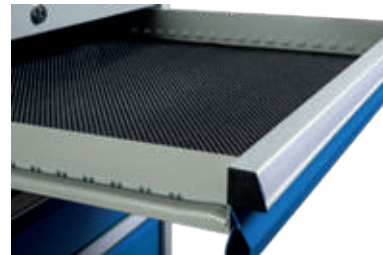

Ribbed rubber insert for drawer

- Oil-proof
- Smooth closing of the drawer also in connection with metal drawer subdivision

Item no.	Dimensions in mm (WxDxH)
120	450 x 600 x 3
140	600 x 600 x 3
160	900 x 600 x 3
186	1200 x 600 x 3



Cover plate

- Beech multiplex, oiled

Item no.	Dimensions in mm (WxDxH)
67.050.017	555 x 736 x 25
67.070.017	705 x 736 x 25
67.100.017	1005 x 736 x 25
67.130.017	1305 x 736 x 25



Cover plate

- Melamine resin coated chipboard
- RAL 7035
- 19 mm, screwable

Item no.	Dimensions in mm (WxDxH)
67.050.016	555 x 736 x 19
67.070.016	705 x 736 x 19
67.100.016	1005 x 736 x 19
67.130.016	1305 x 736 x 19



Shelf

Item no.	Dimensions in mm (WxDxH)
01.050.013	497 x 685 x 40
01.070.013	647 x 685 x 40
01.100.013	947 x 685 x 40
01.130.013	1247 x 685 x 40



Metal roll-off edge on 3 sides

- 20 mm height

Item no.	Dimensions in mm (WxDxH)
66.050.025	555 x 736 x 20
66.070.025	705 x 736 x 20
66.100.025	1005 x 736 x 20
66.130.025	1305 x 736 x 20



Non-slip mat secures tools

- Insert for drawer
- Smooth closing of the drawer also in connection with metal drawer subdivision

Item no.	Dimensions in mm (WxDxH)
65.051.731	450 x 600 x 3
65.071.731	600 x 600 x 3
65.101.731	900 x 600 x 3
65.131.731	1200 x 600 x 3



Soft PVC workbench coverings

- Transparent
- Bluish

Item no.	Dimensions in mm (WxDxH)
015557364TRA	555 x 736 x 4
017057364TRA	705 x 736 x 4
011057364TRA	1005 x 736 x 4
011307364TRA	1305 x 736 x 4



Shelf pull-out

- Full pull-out 100 %, load capacity 100 kg

Item no.	Grid
60.050.AZ VA	R 18-24
60.070.AZ VA	R 24-24
60.100.AZ VA	R 36-24
60.130.AZ VA	R 48-24



Machine feet for drawer cabinets

- Load capacity 1200 kg
- plate Ø 50 mm
- Base made of polished and chrome-plated sheet steel
- Easy height adjustment with vibration damping

Item no.	Packaging unit
01.ASF50-M8	Set with 4 pieces

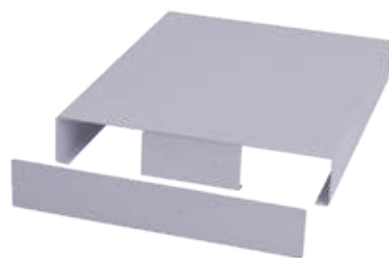

Lift truck base

- Cover plate front and rear

Item no.	Dimensions in mm (WxDxH)
01.050.012	555 x 736 x 112
01.070.012	705 x 736 x 112
01.100.012	1005 x 736 x 112
01.130.012	1305 x 736 x 112



Mobile addition

- 2x plastic push handle
- With 2 fixed and 2 steering casters Ø 125 mm, of which 2 with locks
- Steel plate for 555 mm and 705 mm width
- Steel tub for 1005 mm width



Item no.	Dimensions in mm (WxDxH)	Push handle arrangement
01.050.009	555 x 736 x 150	front
01.070.009	705 x 736 x 150	front
01.100.009	1005 x 736 x 150	front

Grid: R 12-14 R 24-12 R 12-16 R 18-16 R 24-16 R 36-16 R 18-24 R 24-24 R 36-24 R 48-24

For all series

The drawer inserts are made from high-grade plastic and can be inserted into the drawer using the modular principle.

The trough plates and small parts boxes can be inserted lengthwise and widthwise. Basic grid 150 x 150 mm. Material ABS.



Trough plates 150 x 150 x 30 mm



- With 2 troughs 70 mm

Item no.	Packaging unit
50.002.070	1
50002070SE	4



- With 3 troughs 46 mm

Item no.	Packaging unit
50.003.046	1
50003046SE	4



- With 4 troughs 34 mm

Item no.	Packaging unit
50.004.034	1
50004034SE	4

Trough dividers including labelling strip



- For 1x trough
- Wide 68 mm

Item no.	Packaging unit
51.002.070	1
51002070SE	10



- For 3x trough
- Wide 44 mm

Item no.	Packaging unit
51.003.046	1
51003046SE	20



- For 4x trough
- Wide 32 mm

Item no.	Packaging unit
51.004.034	1
51004034SE	20

Spacer bars

Spacer bars are used to secure the plastic subdivision per drawer. Sizes that are not indicated do not require spacer bars.

Spacer bars for trough plates

Item no.	Usable drawer dimension
50.500.MP	450 x 600 mm
50.700.MP	600 x 600 mm
50.100.MP	900 x 600 mm

Spacer bars



CCR = Centre compartment rails, DIV = Divider, SPB = Small Parts Box, TP = Trough Plate, SDIV = Slot-in divider
U = Packaging unit



Small parts boxes including labelling strip



Front 50 mm

- 150 x 150 x 28 mm

Item no.	Packaging unit
53.150.150.30	1
5315015030SE	4



Front 75 mm

- 150 x 150 x 52 mm

Item no.	Packaging unit
52.150.150	1
52150150SE	4



Front 100 mm

- 150 x 150 x 66 mm

Item no.	Packaging unit
53.150.150.65	1
5315015065SE	4



Front 50 mm

- 150 x 75 x 28 mm

Item no.	Packaging unit
53.150.075.30	1
5315007530SE	8



Front 75 mm

- 150 x 75 x 52 mm

Item no.	Packaging unit
52.150.075	1
52150075SE	8



Front 100 mm

- 150 x 75 x 66 mm

Item no.	Packaging unit
53.150.075.65	1
5315007565SE	8



Front 50 mm

- 75 x 75 x 28 mm

Item no.	Packaging unit
53.075.075.30	1
5307507530SE	16



Front 75 mm

- 75 x 75 x 52 mm

Item no.	Packaging unit
52.075.075	1
52075075SE	16



Front 100 mm

- 75 x 75 x 66 mm

Item no.	Packaging unit
53.075.075.65	1
5307507565SE	16

Spacer bars

Spacer bars are used to secure the plastic subdivision per drawer. Sizes that are not indicated do not require spacer bars.

For small parts box front 50

50.700.KTK1	600 x 600 mm
50.100.KTK1	900 x 600 mm

For small parts box front 100

50.700.KTK2	600 x 600 mm
50.100.KTK2	900 x 600 mm



Accessories and spare parts

Grid: R 12-14 R 24-12 R 12-16 R 18-16 R 24-16 R 36-16 R 18-24 R 24-24 R 36-24 R 48-24

Aqurado ABS drawer divider

Create order according to the 5S method and organise your workplace more effectively. Well-structured workplace organisation improves work efficiency, reduces search times and thus increases productivity.

Concept:

- Selecting
- Sorting
- Cleaning
- Standardise
- Self-discipline



Textured mat

Item no.	Dimensions in mm (WxD)
03.AQ.555	456 x 600 mm
03.AQ.705	600 x 600 mm
03.AQ.3907	624 x 1584 mm

Score and break to fit textured mat to size.



Item no.	03.AQ-0100	03.AQ-0101	03.AQ-0112	03.AQ-0122	03.AQ-0104	03.AQ-0110
Dimensions in mm (WxDxH)	96 x 48 x 24	96 x 96 x 24	96 x 144 x 24	72 x 192 x 24	96 x 192 x 24	96 x 288 x 24
Internal dimensions in mm (WxDxH)	37 x 85 x 18	85 x 85 x 18	85 x 133 x 18	62 x 181 x 18	85 x 151 x 18	85 x 277 x 18



Item no.	03.AQ-0105	03.AQ-0111	03.AQ-0121	03.AQ-0106	03.AQ-0107	03.AQ-0108
Dimensions in mm (WxDxH)	96 x 96 x 48	96 x 144 x 48	72 x 192 x 48	96 x 192 x 48	96 x 240 x 48	96 x 288 x 48
Internal dimensions in mm (WxDxH)	85 x 85 x 42	85 x 133 x 42	62 x 182 x 42	85 x 181 x 42	85 x 229 x 42	85 x 277 x 42



Item no.	03.AQ-0109	03.AQ-0116	03.AQ-0117	03.AQ-0114	03.AQ-0115
Dimensions in mm (WxDxH)	96 x 336 x 48	144 x 144 x 48	144 x 192 x 48	144 x 384 x 48	240 x 336 x 48
Internal dimensions in mm (WxDxH)	85 x 325 x 42	133 x 133 x 42	133 x 181 x 42	133 x 373 x 42	229 x 325 x 42

Aqrado drawer divider

Drawer cabinets

New



Item no.	03.AQ-2118	03.AQ-2119	03.AQ-2120	03.AQ-2122
Dimensions in mm (WxDxH)	144 x 144 x 48	288 x 96 x 48	288 x 96 x 48	336 x 96 x 48
Collet module	For 10 x collets ER16	For 16 x collets ER25	For 12 x collets ER32	For 13 x collets ER40



	3 troughs	2 troughs	8 troughs	End piece, 1 trough for length adaptation	End piece, 1 trough for length adaptation	End piece, 1 trough for length adaptation
Item no.	03.AQ-0102	03.AQ-0103	03.AQ-0113	03.AQ-1118	03.AQ-1122	03.AQ-1119
Dimensions in mm (WxDxH)	192 x 96 x 24	96 x 288 x 24	144 x 192 x 24	48 x 73 x 24	72 x 92 x 24	96 x 96 x 24
Internal dimensions/trough	24 x 181 x 18	40 x 277 x 18	132 x 22 x 18	Trough 37	Trough 62	Trough 85



	Allen key box 1.5 / 2 / 2.5 / 3 / 4 / 5 / 6 / 8 / 10	Calliper gauge box, up to measuring range 150	Twist drill box, 1.0 - 6.0 0.1 increasing	Twist drill box, 6.1 - 10 0.1 increasing	Open-ended/ring spanners 12 spanners AF 4 - 24	Double-ended ring spanners 8 spanners AF 6 - 24
Item no.	03.AQ-2112	03.AQ-2113	03.AQ-2115	03.AQ-2116	03.AQ-2110	03.AQ-2111
Dimensions in mm (WxDxH)	96 x 288 x 24	96 x 288 x 24	144 x 144 x 48	144 x 192 x 48	240 x 336 x 48	240 x 336 x 48



	Screwdriver box, for 6 screwdrivers	Socket key box 1/2, for 22 pieces AF 10 - 32	Multimedia box for 11 CDs	Adhesive pads PU 34 pieces not shown	Label plate, vertical	Label plate, horizontal
Item no.	03.AQ-2114	03.AQ-2123	03.AQ-2117	03.AQ-4103	03.AQ-4104	03.AQ-4105
Dimensions in mm (WxDxH)	144 x 384 x 48	144 x 384 x 48	144 x 192 x 48		13 x 45	15 x 48

Individual equipment

- Drawer cabinet R 24-24
- Full pull-out 100 %, load capacity 100 kg per drawer



- 7 drawers

Item no.	Dimensions in mm (WxDxH)
700/0421V10	705 x 736 x 1019

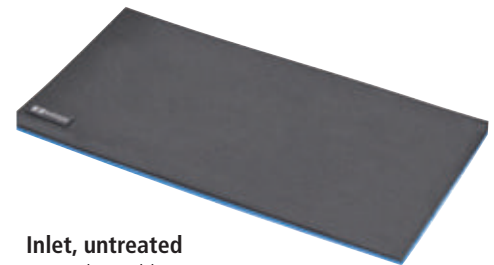

Inlet, untreated

- 2 colours: blue 5 mm
- Black: 20 mm height

Item no.	LxW in mm
08.90.10	600 x 300
08.90.11	600 x 400
08.90.45.60	450 x 600
08.90.60.60	600 x 600
08.90.90.60	900 x 600



Cutting tool, narrow, 20 mm

Item no.
08.90.02



Cutting tool, semi-circular, 20 x 20 mm

Item no.
08.90.03



Cutting tool, wide, 50 mm

Item no.
08.90.01

Detailed description from page 471

Tool sets 565 x 300 mm

New

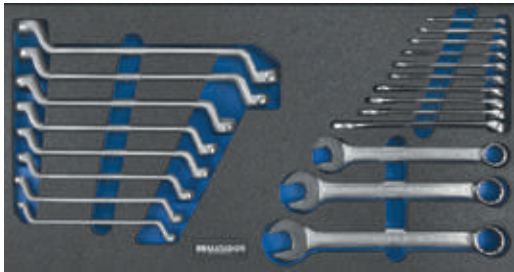

Key set, 21 pcs

Item no.
08.88.204



Tool set, pipe socket and open-ended double ring spanner set 15 pcs.

Item no.
08.88.207



Set of T-handle screwdrivers, 15 pcs

Item no.
08.88.200



Set of pliers/screwdrivers, 14 pcs

Item no.
08.88.206



Set of hammers, files, chisels and saws, 16 pcs

Item no.
08.88.203

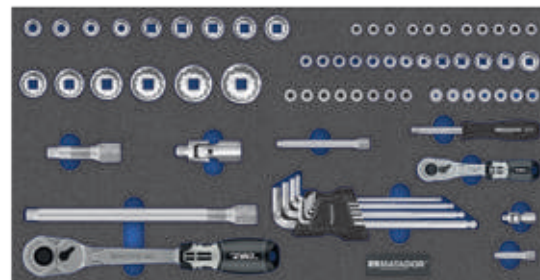

Set of 1/4"-12" socket keys, 71 pcs

Item no.
08.88.205

Locking system

Grid: R 12-14 R 24-12 R 12-16 R 18-16 R 24-16 R 36-16 R 18-24 R 24-24 R 36-24 R 48-24



Mechanical locking

- Cylinder lock with 180° locking
- Handle lock for hinged doors with 90° locking
- Central locking
- Individual locking per drawer possible
- User-friendly operation
- Keyed alike or different locking versions possible

Electronic locking

Pin code

- Operation via keys
- Management with electronic keys
- 4-7 digit numerical code
- Emergency power supply via management key
- Horizontal alignment
- With 90° or 180 °closure

Electronic locking

RFID

- RFID standards: iClass and Mifare
- Management with electronic keys
- Emergency power supply via management key
- Horizontal alignment
- With 90° or 180 °closure



Standard locking with one key

- Opening and closing by turning the key through 180° in the case of Drawers
- Opening and closing by turning the key 90° for hinged doors and hinged doors and single drawers
- Single, different or keyed alike as a locking system

Possibilities:

- Access to any number of locks with one key
- Access to each lock with a different key

Standard version with different locks

Only one specific locker can be opened with each lock

Keyed alike

All locks have the same key

Master key system

With one master key, lockers with different locking systems can be opened.

Mechanical locking

Item no.	Description	version	
01.050.001	Cylinder lock with 2 x keys, 180° locking	different locking	
01.050.002	Cylinder lock with 2 x keys, 180° locking	keyed alike	
01.050.003	Key set of 2		
01.050.005B	Master key for locking system. When reordering, please state the year of purchase.		
03.785.001-1	Cylinder lock with 2 x keys, 90° for single drawer recessed fitted	different locking	
04GSSGS-L-GK	Handle lock left with 2 x key 90° lock	keyed alike	
04GSSGS-R-GK	Handle lock right with 2 x key 90° lock	keyed alike	
04GSSVS-L-GK	Handle lock left with 2 x key 90° lock	different locking	
04GSSVS-R-GK	Handle lock right with 2 x key 90° lock	different locking	

Key management of the e-locks

For programming the e-locks with pin code and RFID, one programming key is required per hall/plant facility. This programming key is used to teach 1-6 management keys. The emergency power supply in case of disregard of the warning signals is possible with the programming key as well as with the management key.

The users are taught in with the help of the management key. With the pin code lock, the user has the option of creating a 4-7-digit individual user code for himself. With the RFID lock, the user learns his RFID chip or card.



User key

Up to 20 users can be assigned per lock, more on request

Management keys

Up to 6 management keys can be assigned per lock.

Programming key

1 programming key is required per lock system



Application	User key	Management key	Programming key
Operation of the lock	X	X	X
General key function		X	X
Inspection function		X	X
External power supply		X	X
Allocation of management keys			X
Assign user key or transponder (only for personal use)		X	
Setting lock function			X

Accessories for e-locks



User key RFID card

- Up to 20 users can be assigned per lock, more on request

Item no.

ML32RFIDK



User key chip

- Up to 20 users can be assigned per lock, more on request

Item no.

ML32CHIP



Management key

- Up to 6 management keys can be management keys can be assigned

Item no.

01ESCHLOSSVS



Programming key

- 1 programming key is required programming key is required

Item no.

01ESCHLOSSPS

Grid: R 12-14 R 24-12 R 12-16 R 18-16 R 24-16 R 36-16 R 18-24 R 24-24 R 36-24 R 48-24



Please note!

To set up an e-lock, you need the key management in the form of the management key and the programming key.

Pin code E-lock

The pin code e-lock can be opened with a 4-7 digit numerical code. The programming of the users and their pin codes is done by means of administration and programming keys.



Video Pin code E-lock

- Key is replaced with numerical code
- Lever mechanism
- Management with management and programming key
- Lock housing made entirely of steel
- Inlet mounting
- Rotation angle 90° or 180°
- Opening and closing by turning the knob
- Operation via buttons; management with electronic keys
- Emergency power supply via management key
- Surface finish: brushed nickel
- Horizontal alignment
- Vertical orientation for vertical pull-outs (MRS®)

Technical data recessed lock

- Locking with a 4-7 digit numerical code
- Protection class IP55
- Power supply via 2x AAA batteries
- Dimensions (W x D x H): 105.17mm x 2.7mm x 29.57 mm (incl. knob 9.75mm)
- 2 years warranty



Technical data surface-mounted lock (retrofitting)

- Locking with a 4-7 digit numerical code
- Protection class IP55
- Power supply via 2 x lithium batteries CR2450
- Dimensions (W x D x H): 133 mm x 31.5 mm x 20.4mm (incl. knob depth 7.7mm)
- 2 years warranty

Pin code E-lock

Item no.	Lock variant	
01PINSLEIN	Pin code E-lock 180° locking, recessed built-in (cannot be retrofitted)	
01PINSLAUF	Pin code E-lock 180° locking, surface-mounted (retrofittable)	
01PINSLEINZ	Pin code E-lock 90° for single drawer recessed fitted	
01PINFLRE	Pin code E-lock hinged right for hinged door	
01PINFLLI	Pin code E-lock hinged left for hinged door	
01PINFL2	Pin code E-lock for double wing door	



Please note!

To set up an e-lock, you need the key management in the form of the management key and the programming key.

RFID E-lock

The RFID e-lock can be opened with an RFID card or a chip. The programming of the locks is done by means of management and programming keys.



Video RFID E-lock

- Key or numerical code is replaced with RFID
- Lever mechanism
- Management with management and programming key
- Operation via RFID
- Inlet mounting
- Rotation angle 90° or 180°
- Opening and closing by turning the knob
- 4 x AA batteries; protection class IP55
- Emergency power supply via management key
- Housing made entirely of metal
- Surface finish: brushed nickel
- Horizontal alignment
- Vertical orientation for vertical pull-outs (MRS®)

Technical data recessed lock

- Closure with RFID standards: iClass and Mifare (13.56 MHz)
ISO 14443A - ISO 14443B - ISO 15693
- Protection class IP55
- Power supply via 4 x AA batteries
- Dimensions (W x D x H): 105.17mm x 2.7mm x 29.57 mm
(incl. knob 9.75mm)
- 2 years warranty

Technical data surface-mounted lock (retrofitting)

- Closure with RFID standards: iClass and Mifare (13.56 MHz)
ISO 14443A - ISO 14443B - ISO 15693
- Protection class IP55
- Power supply via 4 x AA batteries
- Dimensions (W x D x H): 133 mm x 31.5 mm x 20.4 mm
(incl. knob depth 7.7 mm)
- 2 years warranty



RFID E-Lock

Item no.	Lock variant	
01RFIDSLEIN	RFID e-lock 180° locking, recessed built-in (cannot be retrofitted)	
01RFIDSLAUF	RFID e-lock 180° locking, fitted on top (can be retrofitted)	
01RFIDSLEINZ	RFID e-lock 90° for single drawer recessed built-in	
01RFIDFLRE	RFID E-lock hinged right for hinged door	
01RFIDFLLI	RFID E-lock hinged left for hinged door	
01RFIDFL2	RFID e-lock for double wing door	

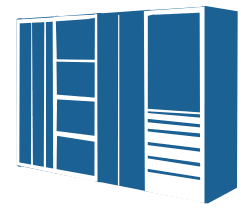

MRS® Modular shelving system





The MRS® at a glance

Page 116



1. Frames and walls

Page 124



2. Shelves and dividers

Page 126



3. Drawers

Page 130



4. Vertical pull-outs

Page 136



5. Accessories for vertical pull-outs

Page 138



6. Hinged doors

Page 140



Finished modules

Page 144



Modulares Regal System at a glance

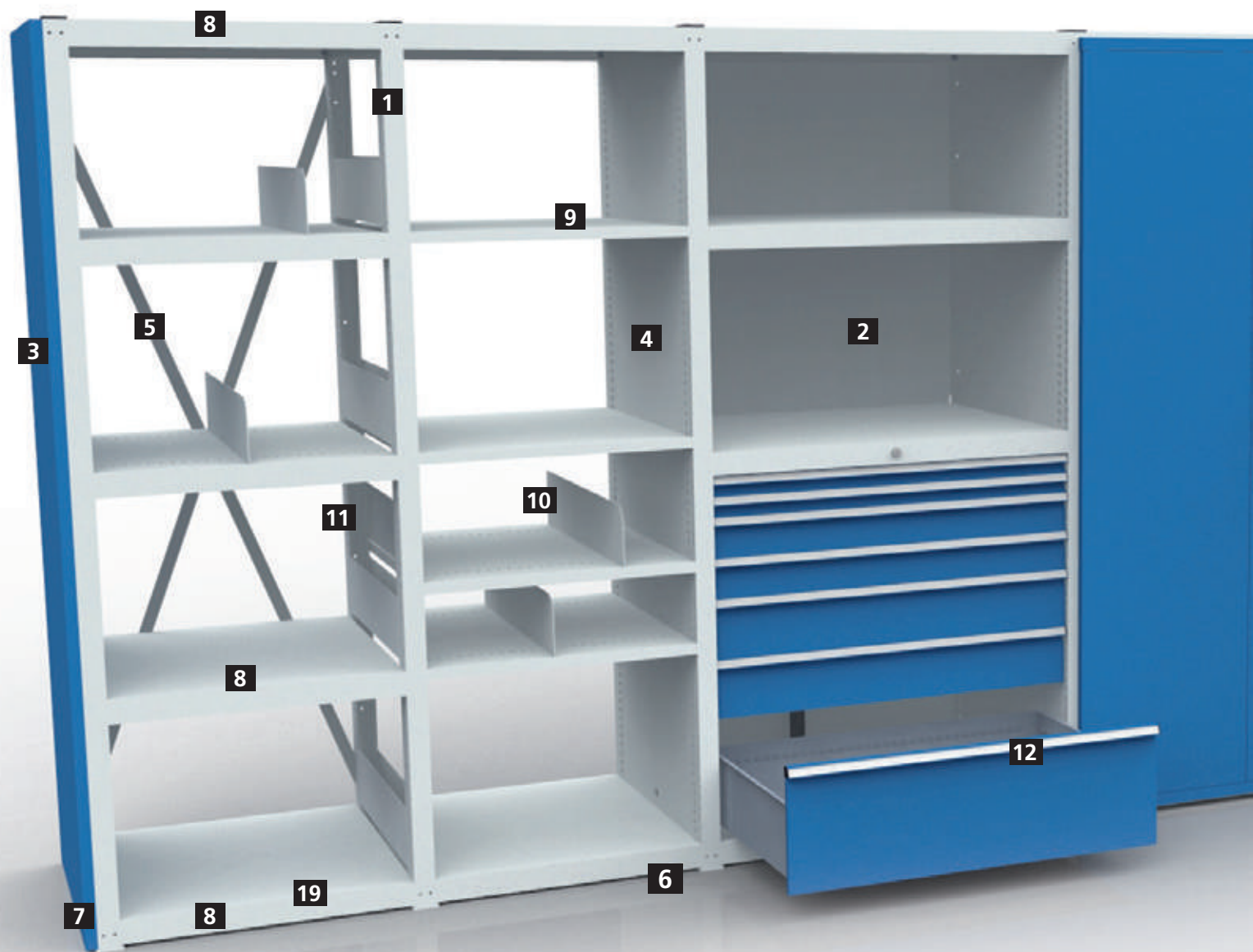

- | | | | |
|-------------------------------|----------|-----------------------------------|----------|
| 1 Support frame | Page 124 | 6 Level compensation plate | Page 124 |
| 2 Rear wall | Page 125 | 7 Floor anchoring | Page 124 |
| 3 Side end wall | Page 125 | 8 Universal shelf 500 kg | Page 127 |
| 4 Partition wall | Page 125 | 9 Shelf 250 kg | Page 127 |
| 5 Diagonal cross-brace | Page 125 | 10 Divider for shelf | Page 126 |



6 steps to your MRS®

Example illustration. Other variants are possible!

1. Frames and walls

Select the required height and width of your drawer shelving and rear wall or diagonal cross-braces for stabilisation.

2. Shelves and dividers

In the 2nd step, you can select your shelves and dividers.

3. Drawers

Select the desired drawers or CNC drawers and if necessary divider materials. Electrical locking systems are also possible.

4. Vertical pull-outs

In the 4th step, you can select vertical pull-outs. These are ideal for heavy CNC tools.

5. Accessories for vertical pull-outs

Here you can obtain accessories such as shelves or perforated walls for vertical pull-outs. Give your MRS® the finishing touch.

6. Hinged doors

Are you still missing hinged doors? You can find these on/ from page 141

11 Side panel	Page 126	16 CNC half shelf	Page 139
12 Drawers	Page 130	17 CNC suspension	Page 139
13 Vertical pull-outs	Page 137	18 Hinged doors	Page 141
14 Half shelf/vertical pull-out	Page 138	19 Fitted shelf	Page 127
15 Perforated wall	Page 138		

Modulares Regal System

The MRS® - modular shelving system - enables flexible interior design at all times. Drawers, shelves, vertical pull-outs, CNC storage systems and closed hinged door cabinets can be ideally integrated into a single product. The system offers three different heights.

The unique feature of the product is its individuality. Configure your drawer shelving as you require. Our extensive range of equipment and accessories offers you a large number of constructive alternatives for implementing highly diverse spatial planning economically. The drawer shelving can be subsequently extended and expanded with additional modules. It combines the advantages of a drawer cabinet with the advantages of shelving, thus creating a product that can be perfectly adapted to your requirements thanks to the optimal use of space. Not only can you use the MRS® as wall cabinet shelving, but also as a room divider.

“ We offer our customers complete support, from planning to installation. ”

Precise visualisation of your draw shelving thanks to our planning programs

With a library containing all our products for the SketchUp drawing program, this planning program - along with the pCon drawing program - is the ideal design tool for fast, efficient, three-dimensional modelling and presentation.

Free, flexible designs are produced in no time at all in order to implement your requirements, layouts, size and colour choice with creativity and dynamism.

By building up our extensive library, we are in a position to visualise your ideas and suggestions quickly and easily in 3D.

Can you visualise what your modular shelving system could look like? Let us show you.



Loads:



UNIVERSAL SHELF



VERTICAL PULL-OUTS



SHELF



DRAWER FP 100 KG



DRAWER FP 180 KG

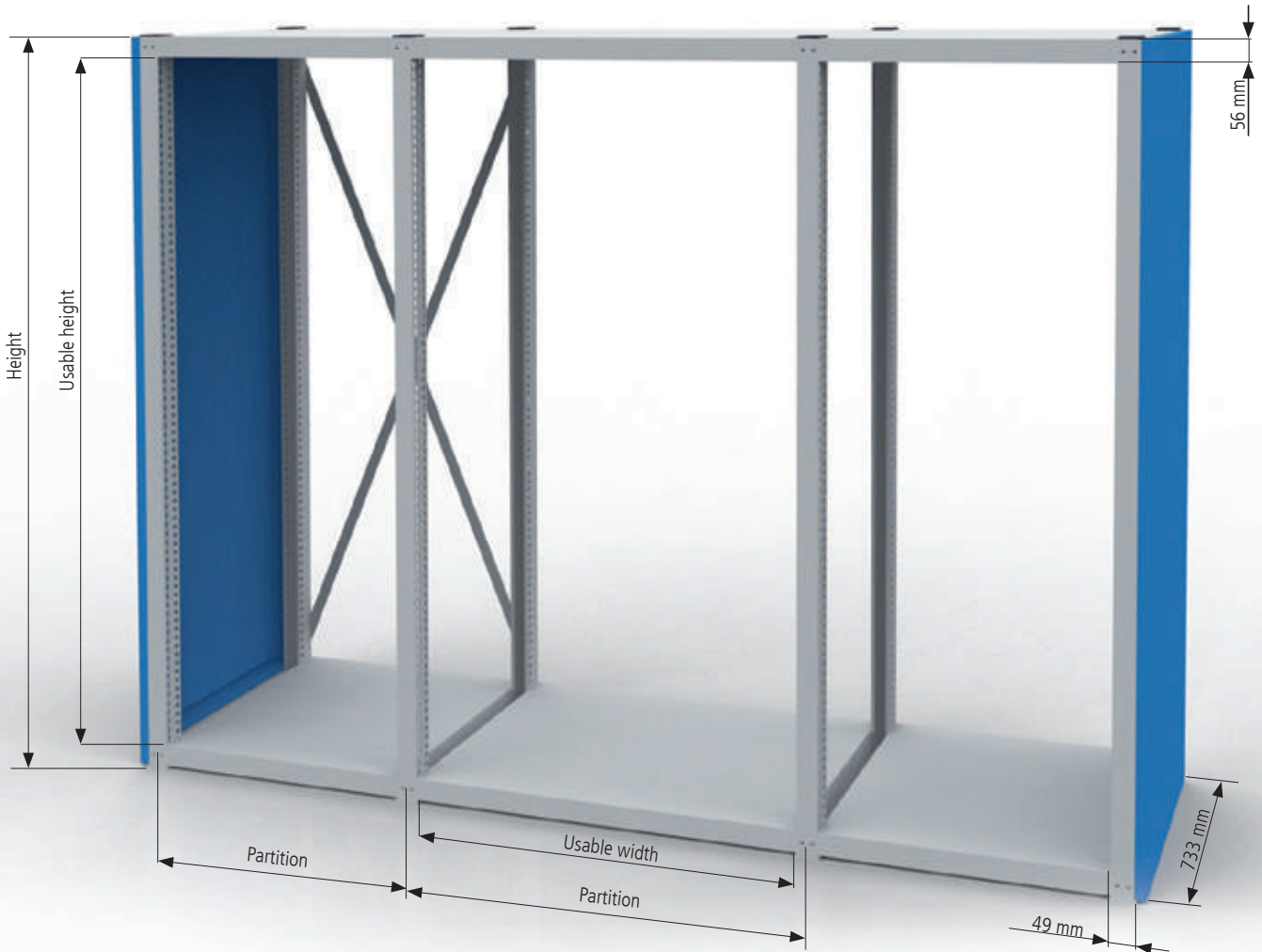

New Heights

Module height

Height in mm	Usable height in mm
1030	906
2030	1906
2430	2306
2830	2706

Module width

Partition	Usable width in mm	Depth in mm
700	651	733
1000	951	733

Usable drawer dimensions

Partition	Internal dimensions in mm	Grid
700	600 x 600	R 24-24
1000	900 x 600	R 36-24

Locking system



Mechanical locking

- Cylinder lock with 180° locking
- Handle lock for hinged doors with 90° locking
- Central locking
- Individual locking per drawer possible
- User-friendly operation
- Keyed alike or different locking versions possible

Electronic locking

Pin code



- Operation via keys
- Management with electronic keys
- 4-7 digit numerical code
- Emergency power supply via management key
- Horizontal alignment
- With 90° or 180° closure

Electronic locking

RFID

- RFID standards: iClass and Mifare
- Management with electronic keys
- Emergency power supply via management key
- Horizontal alignment
- With 90° or 180° closure



Lock 180° for drawer cabinet, recessed built-in | not retrofittable

Item no.	Description	
01.050.001	Cylinder lock	
01PINSLEIN	Pin code E-lock	
01RFIDSLEIN	RFID code E-lock	



Lock 180° for drawer cabinet, fitted on top | retrofittable

Item no.	Description	
01PINSLAUF	Pin code E-lock	
01RFIDSLAUF	RFID code E-lock	

Lock 90° for single drawer, recessed fitted

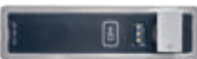

Item no.	Description	
03.785.001-1	Cylinder lock	
01PINSLEINZ	Pin code E-lock	
01RFIDSLEINZ	RFID code E-lock	

Lock 90° for hinged door

Item no.	Description	
04GSSGS-L-GK	Handle lock left with 2 x key, keyed alike	
04GSSGS-R-GK	Grip lock right with 2 x key, keyed alike	
04GSSVS-L-GK	Handle lock on the left with 2 x key, keyed differently	
04GSSVS-R-GK	Grip lock on the right with 2 x key, different keyings	
01PINFLRE	Pin code E-lock hinged right for hinged door	
01PINFLLI	Pin code E-lock hinged left for hinged door	
01PINFL2	Pin code E-lock for double wing door	
01RFIDFLRE	RFID E-lock hinged right for hinged door	
01RFIDFLLI	RFID E-lock hinged left for hinged door	
01RFIDFL2	RFID e-lock for double wing door	

For more information,
see page 137, 141

Lock 180° for vertical pull-out, recessed built-in

Item no.	Description	
01.050.001	Cylinder lock	
01PINSLEIN	Pin code E-lock	
01RFIDSLEIN	RFID code E-lock	



User key

Up to 20 users can be assigned per lock, more on request

Management keys

Up to 6 management keys can be assigned per lock.

Programming key

1 programming key is required per lock system



Application	User key	Management key	Programming key
Operation of the lock	X	X	X
General key function		X	X
Inspection function		X	X
External power supply		X	X
Allocation of management keys			X
Assign user key or transponder (only for personal use)		X	
Setting lock function			X

Accessories for e-locks



User key RFID card

- Up to 20 users can be assigned per lock, more on request

Item no.
ML32RFIDK



User key chip

- Up to 20 users can be assigned per lock, more on request

Item no.
ML32CHIP



Management key

- Up to 6 management keys can be assigned

Item no.
01ESCHLOSSVS



Programming key

- 1 programming key is required

Item no.
01ESCHLOSSPS

Individual solutions

MRS® – the modular shelving system is designed in an endless construction.

Expand your furnishing requirements at any time. If they do not fit in exactly, we will offer you our wall endings as an individual solution. Contact us!

Thanks to its excellent workmanship and material quality, the MRS® is a long-term investment for your company.

- Good price-performance ratio
- High flexibility
- High quality
- Order and structure
- Perfect detailed solutions
- Various RAL colours

Dimensioning in mm

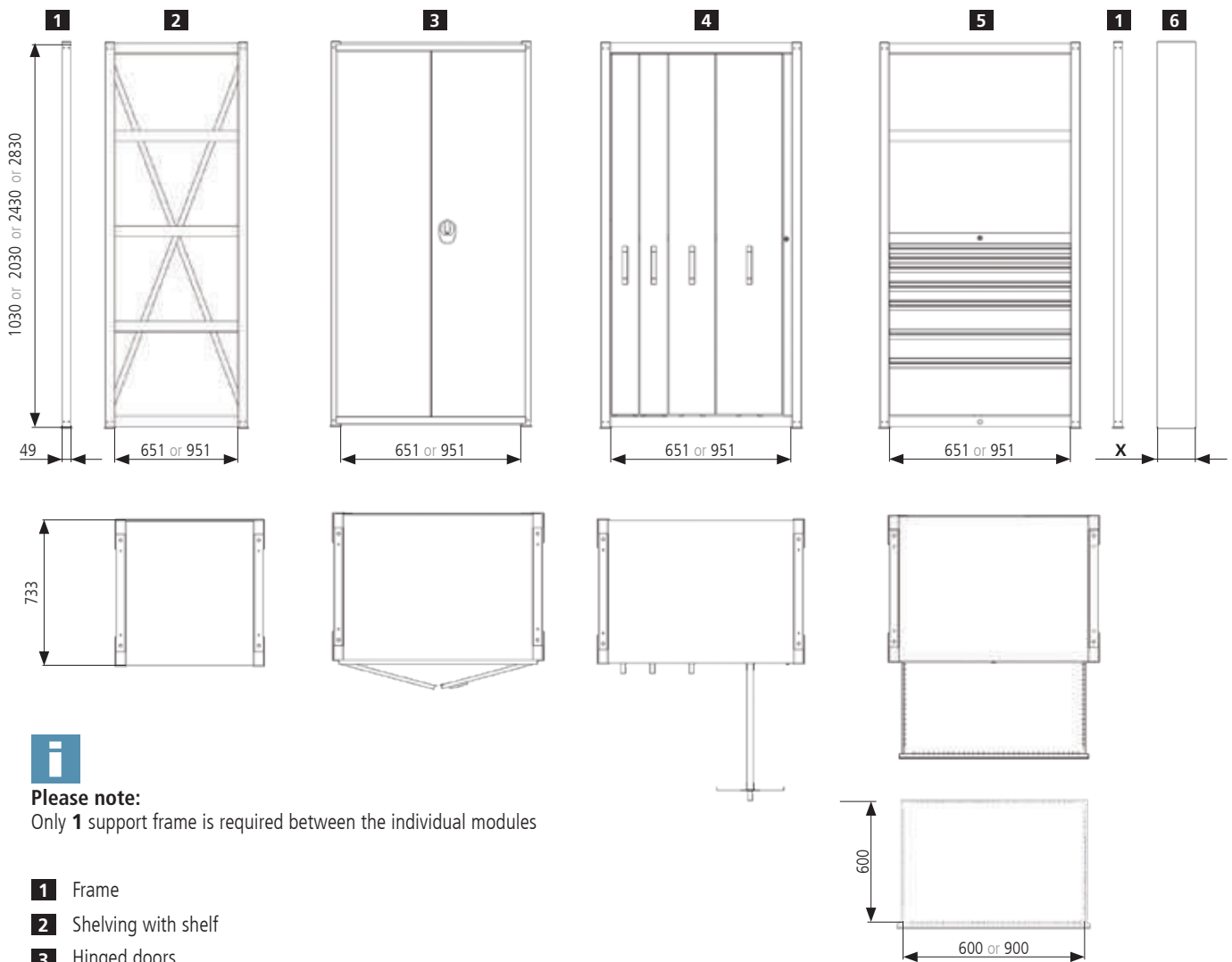

Please note:

Only **1** support frame is required between the individual modules

- 1** Frame
- 2** Shelving with shelf
- 3** Hinged doors
- 4** Vertical pull-out 300 kg
- 5** Drawers FP 100 kg, FP 180 kg
- 6** Wall ending

	SHELVING LENGTH =	number of frames x 49 mm + usable widths. With side end walls, an additional 25 mm must be added per wall.
	WALL ENDING X =	Wall length- SHELVING LENGTH

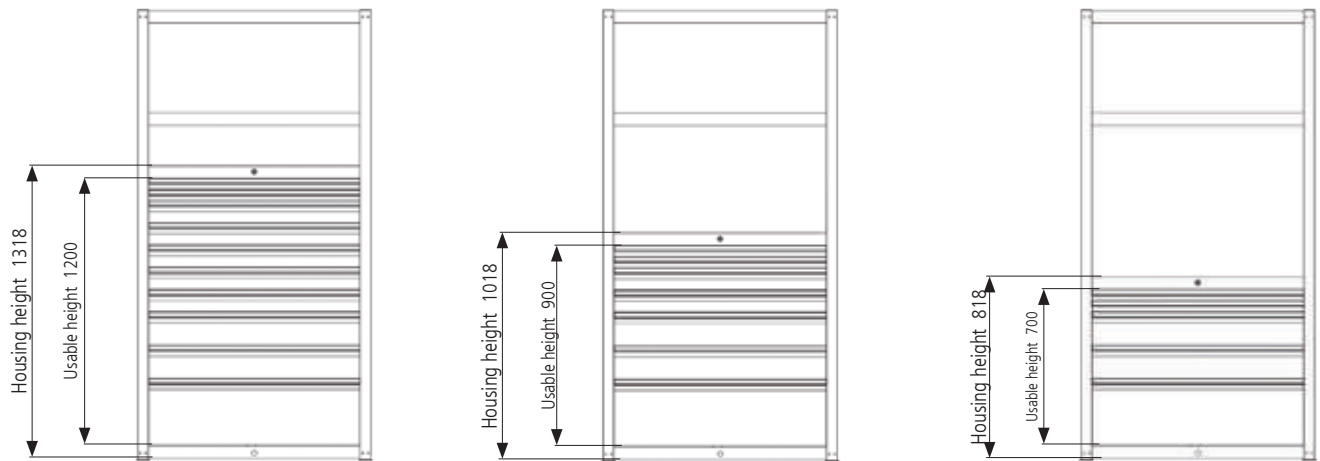
**Please note:**

The usable heights 1400, 1200, 900 and 700 correspond to the total height of fronts.

Example:

Usable height 1400 → 14 x 100 mm front height = 1400 mm total height of fronts

Usable height 1200 → 12 x 100 mm front height = 1200 mm total height of fronts

Usable height 900 → 9 x 100 mm front height = 900 mm total height of fronts

Usable height 700 → 7 x 100 mm front height = 700 mm total height of fronts

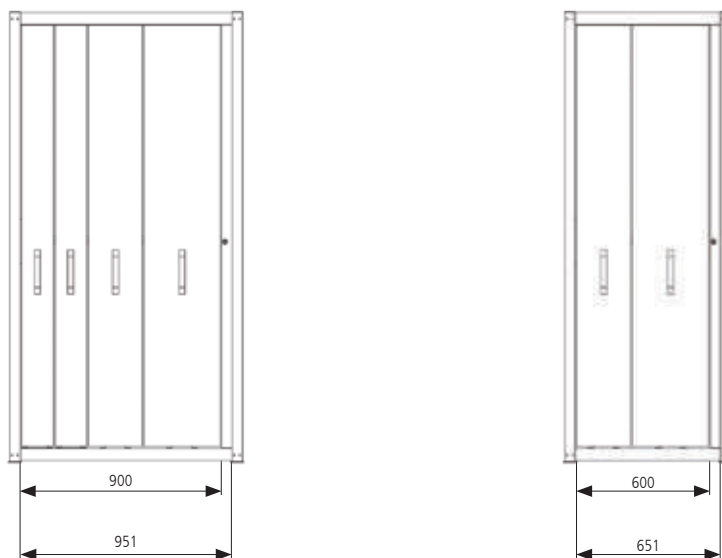
**Please note:**

The usable widths 900 and 600 correspond to the total width of fronts.

Example:

Usable width 900 → 2x 150, 1x 250, 1x 350 mm front width = 900 mm total width of fronts

Usable width 600 → 1x 250, 1x 350 mm front width = 600 mm total width of fronts

Frames and walls

1. Frames and walls



Select the required **height** and **width** of the shelf. For the usable width, you can choose between the two widths **651 mm** and **951 mm**. The support frame with perforations on both sides is used to hang base carriers and drawer rails in position. To achieve a stabilising effect, a divided rear panel made from high-quality steel sheet is bolted into place. Diagonal cross-braces can also be used instead of a rear wall for lengthwise stabilisation. Additionally, you can choose side end walls and partition walls. You can use these in any way you want.



Floor anchoring

- For anchoring the drawer shelving absolutely necessary

Item no.	Dimensions in mm (Ø x H)
SRBV	Ø 12 x 110



Level compensation plate

- Enables precise alignment even on an uneven floor
- Required

Item no.	Dimensions in mm (WxDxH)
SRNAP1	60 x 150 x 1
SRNAP2	60 x 150 x 2
SRNAP4	60 x 150 x 4



Support frame

- Made of high-quality sheet steel
- Carrier with subdividing holes on both sides
- 25 mm spacing between holes
- For hanging the base carriers and drawer rails
- Incl. 1 floor anchors

Item no.	Dimensions in mm (WxDxH)
SRTR100	49 x 733 x 1030
SRTR200	49 x 733 x 2030
SRTR240	49 x 733 x 2430
SRTR280	49 x 733 x 2830

**New height
1018 mm**



Side end wall

- Made of high-quality sheet steel
- For covering the sides of the shelving
- For hanging in the rack frame with base carriers

Item no.	Dimensions in mm (WxDxH)
SRSAW100	25 x 733 x 1018
SRSAW200	25 x 733 x 2018
SRSAW240	25 x 733 x 2418
SRSAW280	25 x 733 x 2818



Partition wall

- Made of high-quality sheet steel
- For hanging in the support frame
- Anti-theft protection
- Can also be used when installing facing doors

Item no.	Dimensions in mm (WxDxH)
SRZW100	18 x 591 x 928
SRZW200	18 x 591 x 1928
SRZW240	18 x 591 x 2328
SRZW280	18 x 591 x 2728



Rear wall

- Made of high-quality sheet steel in two parts
- Rear wall has a stabilising effect
- Prevents reaching through

Item no.	Dimensions in mm (W x H)	Number of parts/height in mm
SRRW070/10	725 x 1003	1 x 1007
SRRW070/20	725 x 2003	2x 1007
SRRW070/24	725 x 2403	1x 1007, 1x 1407
SRRW070/28	725 x 2803	1x 1007, 1x 1807

SRRW100/10	1025 x 1003	1 x 1007
SRRW100/20	1025 x 2003	2x 1007
SRRW100/24	1025 x 2403	1x 1007, 1x 1407
SRRW100/28	1025 x 2803	1x 1007, 1x 1807

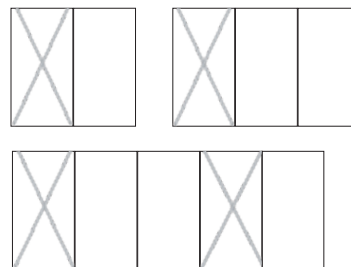

Example arrangements with diagonal cross-braces/rear walls

Diagonal cross-brace

- For lengthwise stabilisation instead of a rear wall from height 2030 mm
- A diagonal cross-brace or a rear wall is required for the 1st and 4th fields
- Standard size for all offered heights and widths

Item no.	Dimensions in mm (WxDxH)
SRDK	728 x 4 x 1870

Shelves and dividers

2. Shelves and dividers



In the 2nd step, you can select your shelves and dividers made of high-quality sheet steel. Universal shelves are used for the top and bottom of the drawer shelving. These are available smooth or slotted and have a load capacity of up to 500 kg. Standard shelves are available with a maximum load capacity of 250 kg. Side panels are used to create the sides of internal spaces. Special dividers are available to subdivide the slotted shelves. In order to use the lower shelf, you require another shelf (universal shelf 500 kg or smooth shelf 250 kg)



Shelf divider for individual subdivision of the slotted shelves.

New



Shelf connector

Item no.	Dimensions in mm (DxH)
SRFBVERB	592 x 80



Divider for shelf

- For subdividing the slotted shelves

Item no.	Dimensions in mm (DxH)
SRFBTB095	700 x 95
SRFBTB145	700 x 145
SRFBTB195	700 x 195



Side panel

- As a side barrier
- Prevents tools/materials from falling off at the sides

Item no.	Dimensions in mm (DxH)
SRSB095	614 x 95
SRSB145	614 x 145
SRSB195	614 x 195

New

2

Floor cover

Is required when the available space above the floor is used as an open compartment.
Example: For hinged doors

1

Fitted shelf

The smooth universal shelf is turned over and placed on the support tray set. A smooth or slotted universal shelf 2 is then placed on top as a floor cover.



Smooth universal shelf

- This shelf is screwed into the support frame as a top and bottom
- Additionally, it can also be used as a heavy load shelf between support frames



Item no.	Dimensions in mm (WxDxH)	Version
1 SRUNFBGL070	651 x 731 x 56	Shelf
1 SRUNFBGL100	951 x 731 x 56	Shelf
2 SRUNDEGL070	651 x 731 x 56	Ground cover
2 SRUNDEGL100	951 x 731 x 56	Ground cover

Universal shelf, slotted

- This shelf is screwed into the support frame as a top and bottom
- Additionally, it can also be used as a heavy load shelf between support frames
- The slots are used to attach dividers



Item no.	Dimensions in mm (WxDxH)	Version
SRUNFBGE070	651 x 731 x 56	Shelf
SRUNFBGE100	951 x 731 x 56	Shelf
2 SRUNDEGE070	651 x 731 x 56	Ground cover
2 SRUNDEGE100	951 x 731 x 56	Ground cover

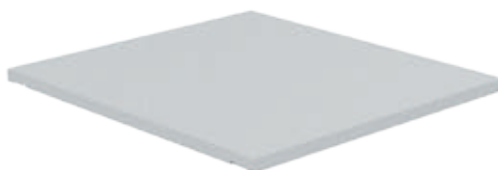

Smooth shelf

- Inserted into the support frame as an intermediate shelf



Item no.	Dimensions in mm (WxDxH)
SRFBGL070	651 x 731 x 25
SRFBGL100	951 x 731 x 25

Slotted shelf

- Inserted into the support frame as an intermediate shelf
- The slots are used to attach dividers



Item no.	Dimensions in mm (WxDxH)
SRFBGE070	651 x 731 x 25
SRFBGE100	951 x 731 x 25

3. Drawers



In the next step, you have the opportunity to adapt the drawer and the drawer divider material to your requirements. Furthermore, you can incorporate various locking systems. You can also select the variants for your CNC area.



Please note:

The usable heights 700, 900, 1200 oder 1400 correspond to the total height of fronts.

EXAMPLE:

Usable height 700 → 7 x 100 mm front height = 700 mm total height of fronts

Usable height 900 → 9 x 100 mm front height = 900 mm total height of fronts

Usable height 1200 → 12 x 100 mm front height = 1200 mm total height of fronts

Usable height 1400 → 14 x 100 mm front height = 1400 mm total height of fronts

Electrical locking systems
please see page 120



New
height

Support tray set with cylinder lock for drawer

- Cylinder lock and two keys
- Various locking mechanisms can be incorporated into the top

Item no.	Dimensions in mm (WxDxH)	Usable drawer heights H	Grid
SRSTS070/080	651 x 731 x 818	700	24-24
SRSTS070/100	651 x 731 x 1018	900	24-24
SRSTS070/130	651 x 731 x 1318	1200	24-24
SRSTS070/150	651 x 731 x 1518	1400	24-24
SRSTS100/080	951 x 731 x 818	700	36-24
SRSTS100/100	951 x 731 x 1018	900	36-24
SRSTS100/130	951 x 731 x 1318	1200	36-24
SRSTS100/150	951 x 731 x 1518	1400	36-24



A rear wall is essential when using drawers. Partition walls or side end walls are important due to the locking mechanism so that anti-theft protection is ensured.

Width 600 mm | Depth 600 mm

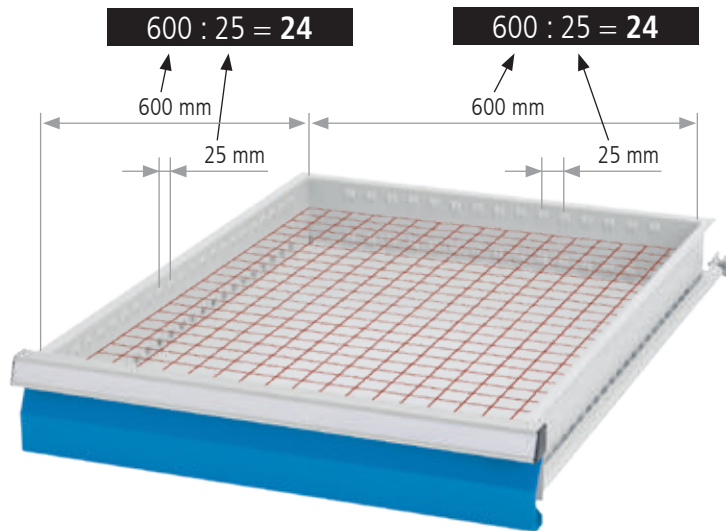

Width 600 x 600 with full pull-out 100 % - 70/100 kg

Item no.	Front height	Shell height	Usable height	Load capacity
60.70.050V07	50	28	30	70 kg
60.70.075V10	75	56	58	100 kg
60.70.100V10	100	81	83	100 kg
60.70.125V10	125	81	108	100 kg
60.70.150V10	150	131	133	100 kg
60.70.175V10	175	131	158	100 kg
60.70.200V10	200	181	183	100 kg
60.70.250V10	250	181	233	100 kg
60.70.300V10	300	181	283	100 kg

Drawers with load capacity 300 kg see page 85



Width 600 x 600 with full pull-out 100 % - 180 kg

Item no.	Front height	Shell height	Usable height	Load capacity
60.70.100V18	100	81	83	180 kg
60.70.125V18	125	81	108	180 kg
60.70.150V18	150	131	133	180 kg
60.70.175V18	175	131	158	180 kg
60.70.200V18	200	181	183	180 kg
60.70.250V18	250	181	233	180 kg
60.70.300V18	300	181	283	180 kg

Drawer inserts | ABS

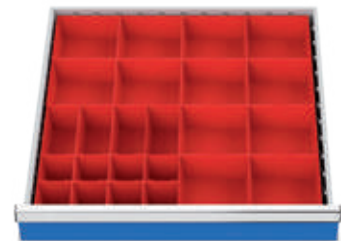
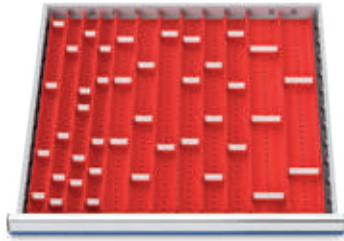

Trough plates | 56 parts

- 4x TP with 4 troughs
- 8x TP with 3 troughs
- 4x TP with 2 troughs
- 18x SDIV for 4 troughs
- 17x SDIV for 3 troughs
- 5x SDIV for 2 troughs

Item no.	Front height in mm
130	50/75

Small parts boxes | 32 parts

- 8x SPB 150 x 150 mm
- 8x SPB 75 x 150 mm
- 16x SPB 75 x 75 mm

Item no.	Front height in mm
132BLH50	50
132BLH75	75
132BLH100	100

Small parts boxes | 24 parts

- 12x SPB 150 x 150 mm
- 4x SPB 75 x 150 mm
- 8x SPB 75 x 75 mm

Item no.	Front height in mm
134BLH50	50
134BLH75	75
134BLH100	100



Metal divider | 7 parts

- 2x CCR 600 mm
- 5x DIV 200 mm

Item no.	Front height in mm
135BLH50	50
135BLH75	75
135BLH100	100/125
135BLH150	150/175
135BLH200	200/300



Metal divider | 13 parts

- 3x CCR 600 mm
- 10x DIV 150 mm

Item no.	Front height in mm
138BLH50	50
138BLH75	75
138BLH100	100/125
138BLH150	150/175
138BLH200	200/300



Metal divider | 11 parts

- 2x CCR 600 mm
- 3x DIV 100 mm
- 3x DIV 200 mm
- 3x DIV 300 mm

Item no.	Front height in mm
147BLH75	75
147BLH100	100/125
147BLH150	150/175
147BLH200	200/300



Metal divider | 10 parts

- 2x CCR 600 mm
- 8x DIV 200 mm

Item no.	Front height in mm
139BLH50	50
139BLH75	75
139BLH100	100/125
139BLH150	150/175
139BLH200	200/300



Metal divider | 5 parts

- 1x CCR 600 mm
- 4x DIV 300 mm

Item no.	Front height in mm
144BLH75	75
144BLH100	100/125
144BLH150	150/175
144BLH200	200/300

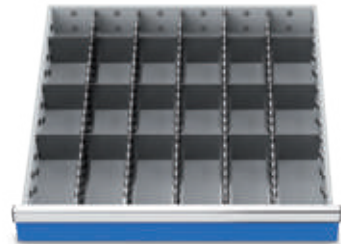

Metal divider | 23 parts

- 5x CCR 600 mm
- 18x DIV 100 mm

Item no.	Front height in mm
149BLH50	50
149BLH75	75
149BLH100	100/125
149BLH150	150/175
149BLH200	200/300

CCR = Centre compartment rails, DIV = Divider, SPB = Small Parts Box, TP = Trough Plate, SDIV = Slot-in divider

Width 900 mm | Depth 600 mm

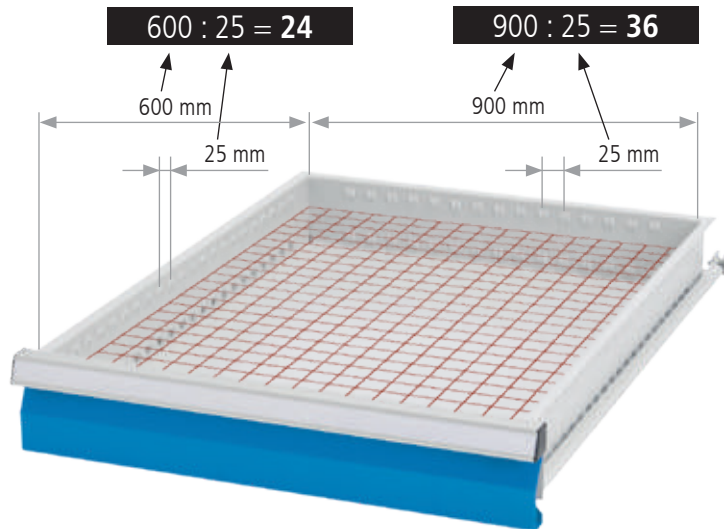

Width 900 x 600 with full pull-out 100 % - 70/100 kg

Item no.	Front height	Shell height	Usable height	Load capacity
60.10.050V07	50	28	30	70 kg
60.10.075V10	75	56	58	100 kg
60.10.100V10	100	81	83	100 kg
60.10.125V10	125	81	108	100 kg
60.10.150V10	150	131	133	100 kg
60.10.175V10	175	131	158	100 kg
60.10.200V10	200	181	183	100 kg
60.10.250V10	250	181	233	100 kg
60.10.300V10	300	181	283	100 kg

Drawers with load capacity
300 kg
see page 85



Width 900 x 600 with full pull-out 100 % - 180 kg

Item no.	Front height	Shell height	Usable height	Load capacity
60.10.100V18	100	81	83	180 kg
60.10.125V18	125	81	108	180 kg
60.10.150V18	150	131	133	180 kg
60.10.175V18	175	131	158	180 kg
60.10.200V18	200	181	183	180 kg
60.10.250V18	250	181	233	180 kg
60.10.300V18	300	181	283	180 kg

Drawer inserts | ABS

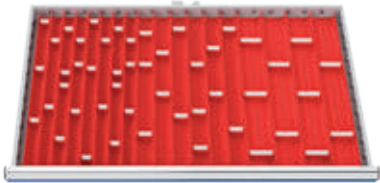

Trough plates | 71 parts

- 8x TP with 4 troughs
- 8x TP with 3 troughs
- 8x TP with 2 troughs
- 23x SDIV for 4 troughs
- 14x SDIV for 3 troughs
- 10x SDIV for 2 troughs

Item no.	Front height in mm
150	50/75



Small parts boxes | 40 parts

- 16x SPB 150 x 150 mm
- 8x SPB 75 x 150 mm
- 16x SPB 75 x 75 mm

Item no.	Front height in mm
159BLH50	50
159BLH75	75
159BLH100	100/125

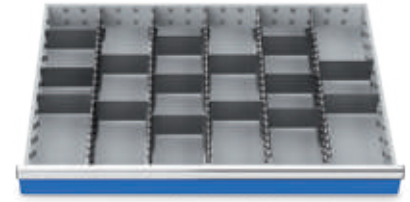

Metal divider | 20 parts

- 5x CCR 600 mm
- 15x DIV 150 mm

Item no.	Front height in mm
153BLH50	50
153BLH75	75
153BLH100	100/125
153BLH150	150/175
153BLH200	200/300



Metal divider | 5 parts

- 2x CCR 600 mm
- 3x DIV 300 mm

Item no.	Front height in mm
155BLH75	75
155BLH100	100/125
155BLH150	150/175
155BLH200	200/300



Metal divider | 24 parts

- 4x CCR 600 mm
- 16x DIV 150 mm
- 4x DIV 300 mm

Item no.	Front height in mm
171BLH75	75
171BLH100	100/125
171BLH150	150/175
171BLH200	200/300

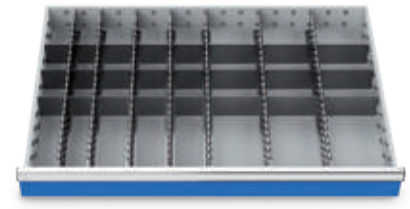

Metal divider | 31 parts

- 7x CCR 600 mm
- 6x DIV 75 mm
- 9x DIV 100 mm
- 9x DIV 150 mm

Item no.	Front height in mm
172BLH50	50
172BLH75	75
172BLH100	100/125
172BLH150	150/175
172BLH200	200/300

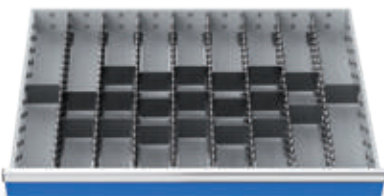

Metal divider | 29 parts

- 8x CCR 600 mm
- 21x DIV 100 mm

Item no.	Front height in mm
161BLH50	50
161BLH75	75
161BLH100	100/125
161BLH150	150/175
161BLH200	200/300



Metal divider | 10 parts

- 2x CCR 600 mm
- 8x DIV 300 mm

Item no.	Front height in mm
166BLH75	75
166BLH100	100/125
166BLH150	150/175
166BLH200	200/300



Metal divider | 15 parts

- 3x CCR 600 mm
- 9x DIV 200 mm
- 3x DIV 300 mm

Item no.	Front height in mm
170BLH75	75
170BLH100	100/125
170BLH150	150/175
170BLH200	200/300

CCR = Centre compartment rails, DIV = Divider, SPB = Small Parts Box, TP = Trough Plate, SDIV = Slot-in divider

CNC drawers

Drawer frames for drawers R 24-24

R 24-24

Static and flexible version | Width 600 – Drawer frame and single carrier

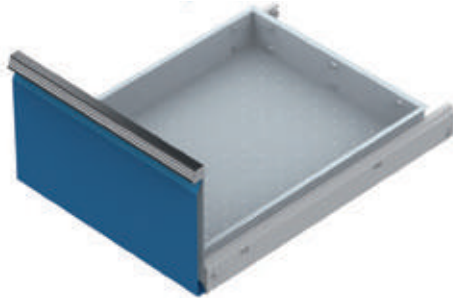

CNC drawers
Width 600 x 600 with full pull-out 100% - 180 kg



Item no.	Front height	Shell height	Usable height
60.70.30V18CNC	300	81	283
60.70.40V18CNC	400	81	383

Suspension rails for CNC for tool holder carrier (WAT)

- For up to 5 CNC tool holder carriers (WAT)
- For all drawers with 600 mm depth
- Supplied in pairs

Item no.	Dimensions in mm (WxDxH)
02.33.87.60	600 x 25 x 75

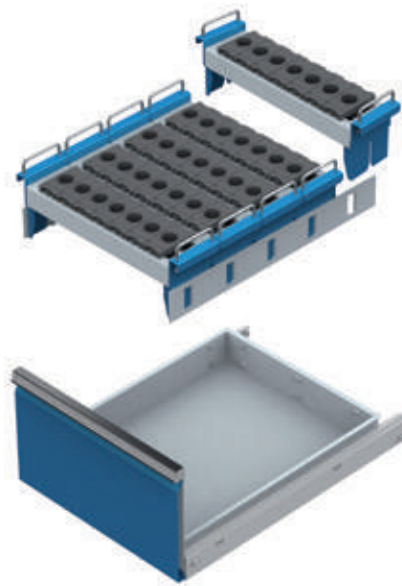
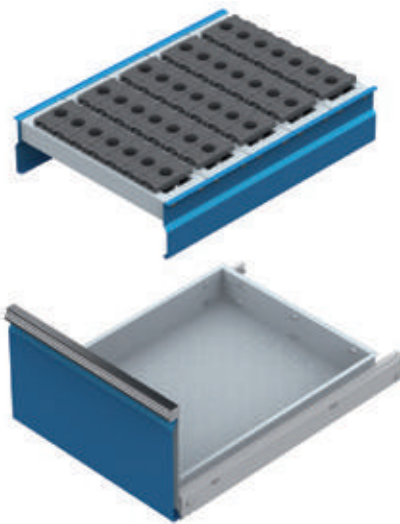

5 single carriers fit in one drawer



CNC drawer frame SR 600 for cabinet R 24-24

Item no.	Dimensions in mm (WxDxH)	CNC E1	CNC E2	CNC E3
02.8707.500	600 x 600 x 130	50*	35*	25*

CNC tool holder carrier (WAT) 600 for cabinet R 24-24

Item no.	Dimensions in mm (WxDxH)	CNC E1	CNC E2	CNC E3
02.8707.100	620 x 120 x 180	10*	7*	5*

*Number of possible inserts for sizes E1, E2, E3

Static and flexible version | Width 900 – Drawer frame and single carrier

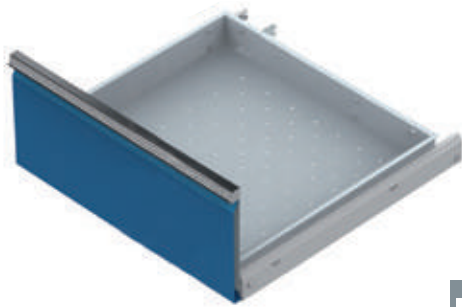

CNC drawers
Width 900 x 600 with full pull-out 100% - 180 kg



Suspension rails for CNC for tool holder carrier (WAT)

- For up to 5 CNC tool holder carriers (WAT)
- For all drawers with 600 mm depth
- Supplied in pairs

Item no.	Front height	Shell height	Usable height
60.10.30V18CNC	300	81	283
60.10.40V18CNC	400	81	383

Item no.	Dimensions in mm (WxDxH)
02.33.87.60	600 x 25 x 75

CNC tool inserts
see page 152/153

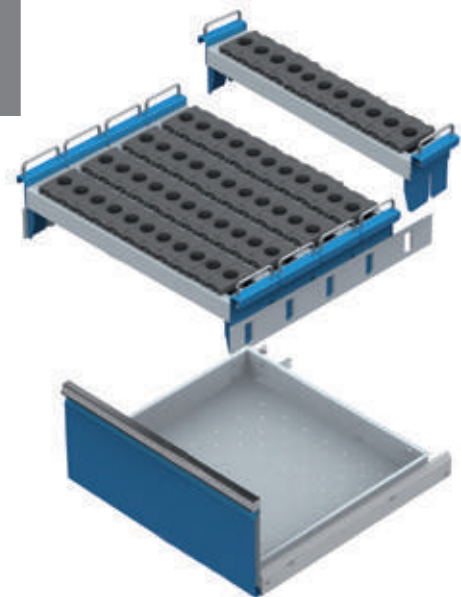
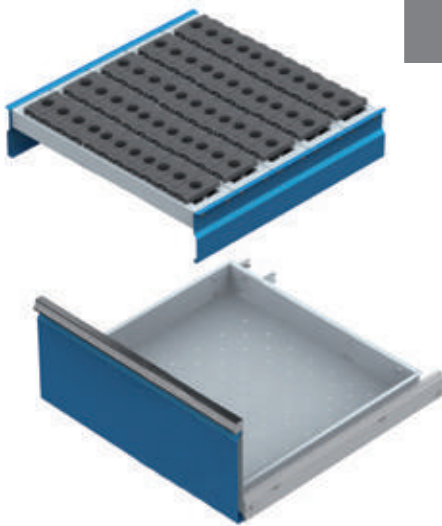

5 single carriers fit in one drawer



CNC drawer frame SR 900 for cabinet R 36-24

Item no.	Dimensions in mm (WxDxH)	CNC E1	CNC E2	CNC E3
02.8710.500	900 x 600 x 130	80*	55*	40*

CNC tool holder carrier (WAT) 900 for cabinet R 36-24

Item no.	Dimensions in mm (WxDxH)	CNC E1	CNC E2	CNC E3
02.8710.100	920 x 120 x 180	16*	11*	8*

*Number of possible inserts for sizes E1, E2, E3

Vertical pull-out

4. Vertical pull-out



Do you need vertical pull-outs? They can be used in the CNC area and are essential for ensuring order in your workshop. Select the size of the vertical pull-outs here. They are noted for their high-quality powder-coated sheet steel construction with a load capacity of 300 kg per full pull-out. Also note the perforated panels, which can be used on both sides on telescopic pull-outs with ball bearing guides, and the complementary range of hooks. You will find more extras on the following pages.



Please note:

The usable widths 900 and 600 correspond to the total width of fronts.

EXAMPLE:

Usable width 900 → 3x 300 mm front width = 900 mm total width of fronts

Usable width 600 → 3x 200 mm front width = 600 mm total width of fronts



Support tray set with cylinder lock for vertical pull-out

- Generally with cylinder lock and 2 keys
- Optionally, electronic locking mechanisms can be incorporated
- Maximum load capacity per drawer shelf 900 kg



Item no.	Dimensions in mm (WxDxH)	For vertical pull-out	Usable width W in mm
SRSTV070/100	651 x 731 x 1018	700/1000	600
SRSTV070/200	651 x 731 x 2018	700/2000	600
SRSTV070/240	651 x 731 x 2418	700/2400	600
SRSTV070/280	651 x 731 x 2818	700/2800	600
SRSTV100/100	951 x 731 x 1018	1000/1000	900
SRSTV100/200	951 x 731 x 2018	1000/2000	900
SRSTV100/240	951 x 731 x 2418	1000/2400	900
SRSTV100/280	951 x 731 x 2818	1000/2800	900

Top and bottom shelf as well as locking system included in delivery, support frame must be ordered separately.



Electronical locking system
for vertical pull-out
More information,
see page 120



Vertical pull-outs

- Soft pull-in
- Full pull-out
- Load capacity per vertical pull-out 300 kg
- **Assembly/installation by professional installation team is recommended**

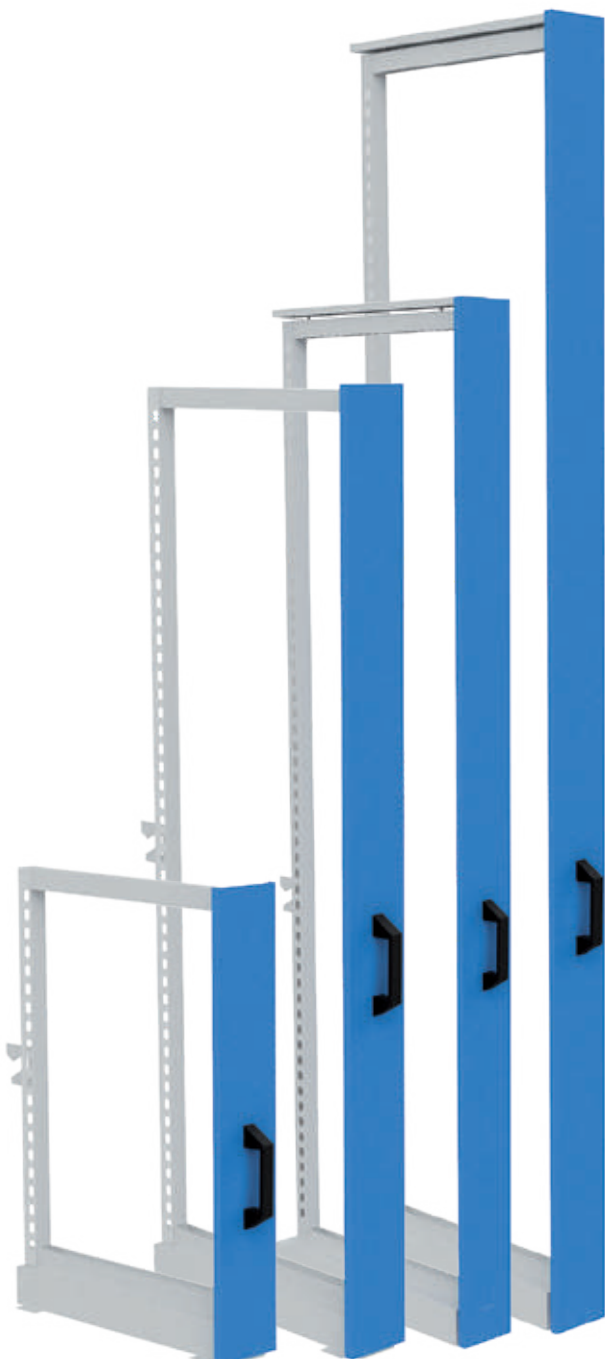

Item no.	Front width in mm	Dimensions in mm (WxDxH)
SRVZ150/100	150	145 x 692 x 905
SRVZ150/200	150	145 x 692 x 1905
SRVZ150/240	150	145 x 692 x 2305
SRVZ150/280	150	145 x 692 x 2705

Item no.	Front width in mm	Dimensions in mm (WxDxH)
SRVZ200/100	200	195 x 692 x 905
SRVZ200/200	200	195 x 692 x 1905
SRVZ200/240	200	195 x 692 x 2305
SRVZ200/280	200	195 x 692 x 2705

Item no.	Front width in mm	Dimensions in mm (WxDxH)
SRVZ250/100	250	245 x 692 x 905
SRVZ250/200	250	245 x 692 x 1905
SRVZ250/240	250	245 x 692 x 2305
SRVZ250/280	250	245 x 692 x 2705

Item no.	Front width in mm	Dimensions in mm (WxDxH)
SRVZ300/100	300	295 x 692 x 905
SRVZ300/200	300	295 x 692 x 1905
SRVZ300/240	300	295 x 692 x 2305
SRVZ300/280	300	295 x 692 x 2705

Item no.	Front width in mm	Dimensions in mm (WxDxH)
SRVZ350/100	350	345 x 692 x 905
SRVZ350/200	350	345 x 692 x 1905
SRVZ350/240	350	345 x 692 x 2305
SRVZ350/280	350	345 x 692 x 2705

Accessories for vertical pull-outs

5. Accessories for vertical pull-outs

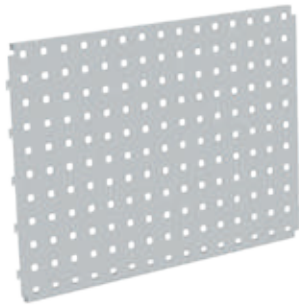

Perforated wall for vertical pull-out

Item no.	Dimensions in mm (WxDxH)
SRVZLW416	590 x 12 x 416

- Maximum number of perforated walls that fits on one side of the vertical pull-out
- Can also be hung on both sides

Support frame height	Number of perforated walls
1030	2 pieces
2030	4 pieces
2430	5 pieces
2830	5 pieces



Half shelf for vertical pull-out

- Can be hung on both sides, creating a full-length support surface

Item no.	Dimensions in mm (WxDxH)	Usable area in mm
SRHFBVZ150	592 x 67 x 91	588 x 61
SRHFBVZ200	592 x 90 x 91	588 x 86
SRHFBVZ250	592 x 115 x 91	588 x 111
SRHFBVZ300	592 x 140 x 91	588 x 136
SRHFBVZ350	592 x 165 x 91	588 x 161

For vertical pull-outs with a width from 200, the following perforated wall accessories are possible. Others on request



Tool clamp, single, small base plate

Item no.	Dimensions in mm (Ø)
03.87.331	6
03.87.332	10
03.87.333	13
03.87.334	16
03.87.335	19



Double tool clamp

Item no.	Dimensions in mm (Ø)
03.87.341	6
03.87.342	10
03.87.343	13
03.87.344	16
03.87.345	19



Double tool holder with slanted hook ends

- Ø 6 mm

Item no.	Dimension in mm (W)
03.87.322	50
03.87.323	75
03.87.324	150



Tool holder with vertical hook end

- Ø 6 mm

Item no.	Dimension in mm (W)
03.87.311	35
03.87.312	75
03.87.313	125



Pliers holder

Item no.	Dimensions in mm (WxD)
03.87.409	20 x 35
03.87.410	50 x 40
03.87.411	75 x 50
03.87.412	20 x 55
03.87.413	20 x 75



Round holder

Item no.	Dimensions in mm (WxD)
03.87.355	65 x 25



CNC half shelf | Static variant for vertical pull-out from a width of 250 mm

- Usable area: 588 x 61 mm

Item no.	Dimensions in mm (WxDxH)	CNC E1	CNC E2	CNC E3
SRVAHFBCN250	592 x 117 x 124	*10	*7	*5

*Number of possible inserts for sizes E1, E2, E3



CNC suspension | Flexible variant for vertical pull-out from a width of 300 mm

- Hang your tool holder carrier here **02.8707.100** (see page 134)

Item no.	Dimensions in mm (WxDxH)
SRVACNWAT300	70 x 49 x 150



Slotted cross-member

- Holds long tools, pipes, etc.

Item no.	Dimensions in mm (WxDxH)
SRTRGE	72 x 20 x 630

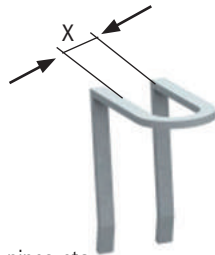

Bracket

- Tilt protection for tools, pipes, etc.

Item no.	Dimensions in mm (WxDxH)	Internal dimensions x
SRHB025	49 x 33 x 71	17
SRHB050	49 x 58 x 71	42
SRHB075	49 x 83 x 71	67
SRHB100	49 x 108 x 71	92



Storage rack

- Lower stop for tools, pipes, etc.
- 2 storage racks are needed in order to utilise the entire depth
- Is hung in the slotted cross-member (SRTRGE)

Item no.	Dimensions in mm (WxDxH)
SRAB150	273 x 61 x 60
SRAB200	273 x 86 x 60
SRAB250	273 x 111 x 60
SRAB300	273 x 136 x 60

CNC tool holder carrier (WAT) see pages 134/135

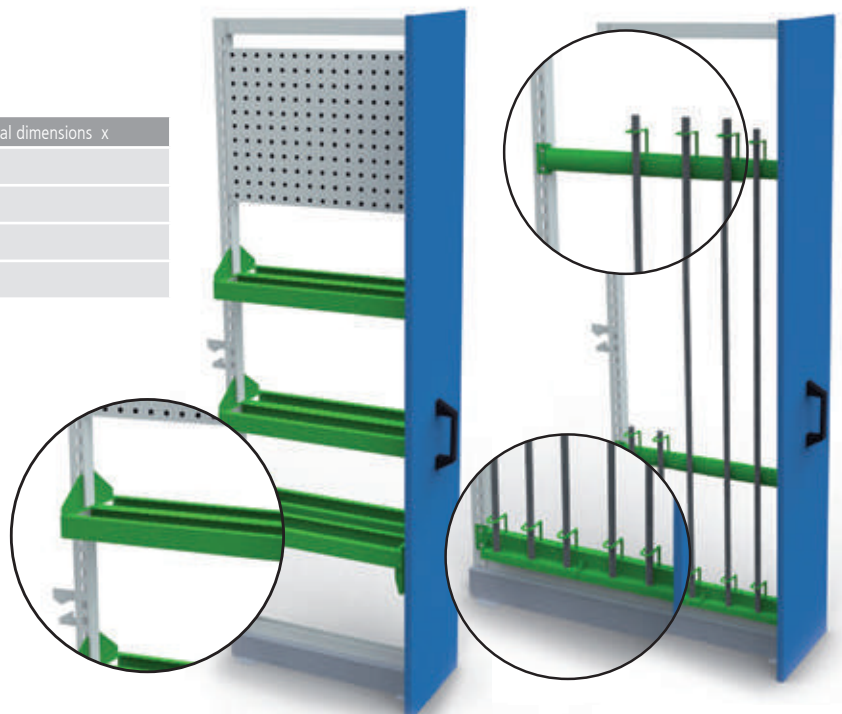

Hinged doors

6. Hinged doors



To protect against theft, our protruding lockable hinged doors ensure optimal protection for access control. This sheet steel construction is very robust and optimally welded. The MRS® has a resistant powder coating. Hinged doors and a PIN code lock can be retrofitted.





Electronical locking system
for hinged doors
More information,
see page 120



Hinged door assembly

- With rotary handle - cylinder lock
- A rear wall and two partition walls or end walls are additionally required to ensure anti-theft protection

Item no.	Dimensions in mm (WxDxH)
SRFLE070/080	695 x 23 x 792
SRFLE070/100	695 x 23 x 992
SRFLE100/080	995 x 23 x 792
SRFLE100/100	995 x 23 x 992
SRFLO070/080	695 x 23 x 767 Can only be used at top
SRFLO070/100	695 x 23 x 967 Can only be used at top
SRFLO100/080	995 x 23 x 767 Can only be used at top
SRFLO100/100	995 x 23 x 967 Can only be used at top
SRFLE070/200	695 x 23 x 1992
SRFLE070/240	695 x 23 x 2392
SRFLE070/280	695 x 23 x 2792
SRFLE100/200	995 x 23 x 1992
SRFLE100/240	995 x 23 x 2392
SRFLE100/280	995 x 23 x 2792

Shelves for hinged door cabinets can be found on page 127

Modules

Combination options with hinged doors



Support frame		Support tray		Hinged door / only be used on top		Column dimension X
Item no.	Dimensions in mm (WxDxH)	Item no.	Dimensions in mm (WxDxH)	Item no.	Dimensions in mm (WxDxH)	Dimensions in mm
SRTR200	49 x 733 x 2030	SRSTS070/080	651 x 731 x 818	SRFLO070/080	695 x 23 x 767	419
				SRFLO070/100	695 x 23 x 967	219
		SRSTS070/100	651 x 731 x 1018	SRFLO070/080	695 x 23 x 767	219
				SRFLO070/100	695 x 23 x 967	0*
		SRSTS070/130	651 x 731 x 1318	SRFLO070/080	695 x 23 x 767	not possible
				SRFLO070/100	695 x 23 x 967	not possible
		SRSTS070/150	651 x 731 x 1518	SRFLO070/080	695 x 23 x 767	not possible
				SRFLO070/100	695 x 23 x 967	not possible
		SRSTS100/080	951 x 731 x 818	SRFLO100/080	995 x 23 x 767	419
				SRFLO100/100	995 x 23 x 967	219
		SRSTS100/100	951 x 731 x 1018	SRFLO100/080	995 x 23 x 767	219
				SRFLO100/100	995 x 23 x 967	0*
		SRSTS100/130	951 x 731 x 1318	SRFLO100/080	995 x 23 x 767	not possible
				SRFLO100/100	995 x 23 x 967	not possible
SRSTS100/150	951 x 731 x 1518	SRFLO100/080	995 x 23 x 767	not possible		
		SRFLO100/100	995 x 23 x 967	not possible		
SRTR240	49 x 733 x 2430	SRSTS070/080	651 x 731 x 818	SRFLO070/080	695 x 23 x 767	819
				SRFLO070/100	695 x 23 x 967	619
		SRSTS070/100	651 x 731 x 1018	SRFLO070/080	695 x 23 x 767	619
				SRFLO070/100	695 x 23 x 967	419
		SRSTS070/130	651 x 731 x 1318	SRFLO070/080	695 x 23 x 767	319
				SRFLO070/100	695 x 23 x 967	119
		SRSTS070/150	651 x 731 x 1518	SRFLO070/080	695 x 23 x 767	119
				SRFLO070/100	695 x 23 x 967	not possible
		SRSTS100/080	951 x 731 x 818	SRFLO100/080	995 x 23 x 767	819
				SRFLO100/100	995 x 23 x 967	619
		SRSTS100/100	951 x 731 x 1018	SRFLO100/080	995 x 23 x 767	619
				SRFLO100/100	995 x 23 x 967	419
		SRSTS100/130	951 x 731 x 1318	SRFLO100/080	995 x 23 x 767	319
				SRFLO100/100	995 x 23 x 967	119
SRSTS100/150	951 x 731 x 1518	SRFLO100/080	995 x 23 x 767	119		
		SRFLO100/100	995 x 23 x 967	not possible		
SRTR280	49 x 733 x 2830	SRSTS070/080	651 x 731 x 818	SRFLO070/080	695 x 23 x 767	1219
				SRFLO070/100	695 x 23 x 967	1019
		SRSTS070/100	651 x 731 x 1018	SRFLO070/080	695 x 23 x 767	1019
				SRFLO070/100	695 x 23 x 967	819
		SRSTS070/130	651 x 731 x 1318	SRFLO070/080	695 x 23 x 767	719
				SRFLO070/100	695 x 23 x 967	519
		SRSTS070/150	651 x 731 x 1518	SRFLO070/080	695 x 23 x 767	519
				SRFLO070/100	695 x 23 x 967	319
		SRSTS100/080	951 x 731 x 818	SRFLO100/080	995 x 23 x 767	1219
				SRFLO100/100	995 x 23 x 967	1019
		SRSTS100/100	951 x 731 x 1018	SRFLO100/080	995 x 23 x 767	1019
				SRFLO100/100	995 x 23 x 967	819
		SRSTS100/130	951 x 731 x 1318	SRFLO100/080	995 x 23 x 767	719
				SRFLO100/100	995 x 23 x 967	519
SRSTS100/150	951 x 731 x 1518	SRFLO100/080	995 x 23 x 767	519		
		SRFLO100/100	995 x 23 x 967	319		

*UNI shelf is inserted on shelf set (not screwed)

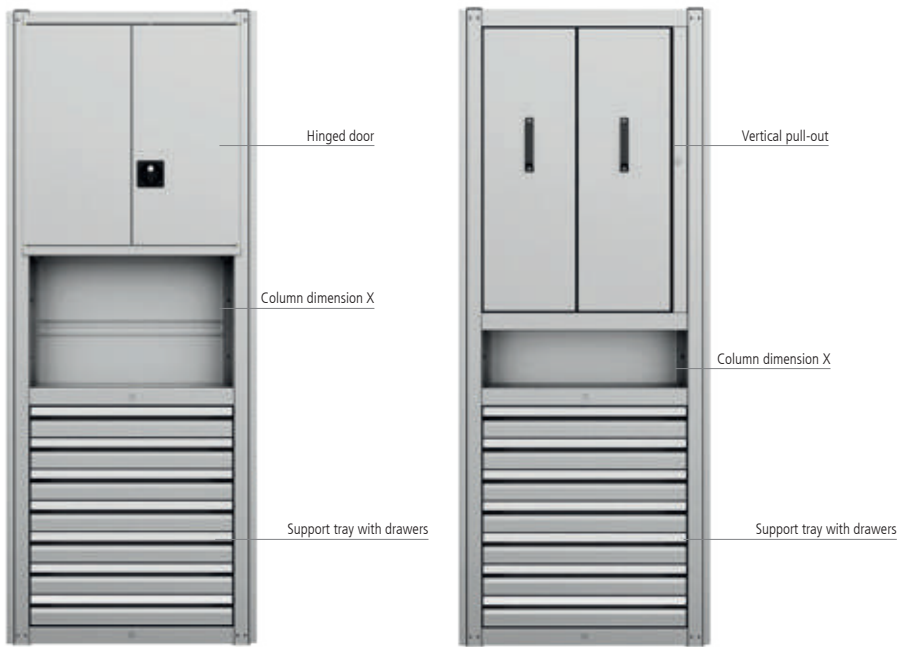

Possible variants for hinged doors and vertical pull-outs



Combination options with vertical pull-out



Support frame

Support tray

Vertical pull-out top

Column dimension X

Item no.	Dimensions in mm (WxDxH)	Item no.	Dimensions in mm (WxDxH)	Item no.	Dimensions in mm (WxDxH)	Dimensions in mm
SRTR200	49 x 733 x 2030	SRSTS070/080	651 x 731 x 818	SRTV070/100	651 x 731 x 1018	182
		SRSTS070/100	651 x 731 x 1018	SRTV070/100	651 x 731 x 1018	not possible
		SRSTS070/130	651 x 731 x 1318	SRTV070/100	651 x 731 x 1018	not possible
		SRSTS070/150	651 x 731 x 1518	SRTV070/100	651 x 731 x 1018	not possible
		SRSTS100/080	951 x 731 x 818	SRTV100/100	951 x 731 x 1018	182
		SRSTS100/100	951 x 731 x 1018	SRTV100/100	951 x 731 x 1018	not possible
		SRSTS100/130	951 x 731 x 1318	SRTV100/100	951 x 731 x 1018	not possible
		SRSTS100/150	951 x 731 x 1518	SRTV100/100	951 x 731 x 1018	not possible
SRTR240	49 x 733 x 2430	SRSTS070/080	651 x 731 x 818	SRTV070/100	651 x 731 x 1018	582
		SRSTS070/100	651 x 731 x 1018	SRTV070/100	651 x 731 x 1018	382
		SRSTS070/130	651 x 731 x 1318	SRTV070/100	651 x 731 x 1018	82
		SRSTS070/150	651 x 731 x 1518	SRTV070/100	651 x 731 x 1018	not possible
		SRSTS100/080	951 x 731 x 818	SRTV100/100	951 x 731 x 1018	582
		SRSTS100/100	951 x 731 x 1018	SRTV100/100	951 x 731 x 1018	382
		SRSTS100/130	951 x 731 x 1318	SRTV100/100	951 x 731 x 1018	82
		SRSTS100/150	951 x 731 x 1518	SRTV100/100	951 x 731 x 1018	not possible
SRTR280	49 x 733 x 2830	SRSTS070/080	651 x 731 x 818	SRTV070/100	651 x 731 x 1018	982
		SRSTS070/100	651 x 731 x 1018	SRTV070/100	651 x 731 x 1018	782
		SRSTS070/130	651 x 731 x 1318	SRTV070/100	651 x 731 x 1018	482
		SRSTS070/150	651 x 731 x 1518	SRTV070/100	651 x 731 x 1018	282
		SRSTS100/080	951 x 731 x 818	SRTV100/100	951 x 731 x 1018	982
		SRSTS100/100	951 x 731 x 1018	SRTV100/100	951 x 731 x 1018	782
		SRSTS100/130	951 x 731 x 1318	SRTV100/100	951 x 731 x 1018	482
		SRSTS100/150	951 x 731 x 1518	SRTV100/100	951 x 731 x 1018	282

Finished modules

Module 1 – 2

- Delivery unassembled



Module 1 | 700

- 2x support frame
- 1x diagonal cross-brace
- 3x smooth universal shelf
- 2x slotted shelf
- 8x shelf side panel
- 5x shelf divider
- 1x fitted shelf

Item no.	Dimensions in mm (WxDxH)
SRK01	749 x 733 x 2030

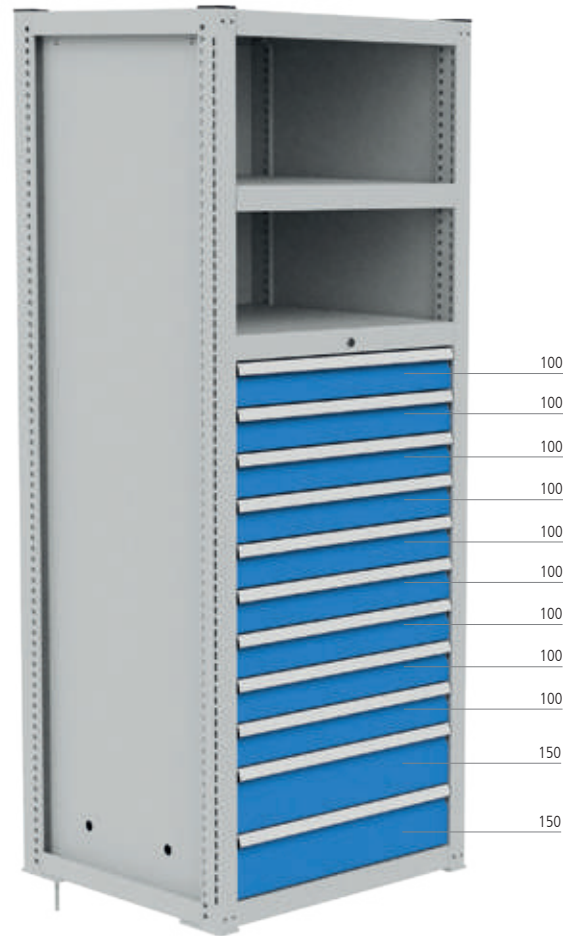

Module 2 | 700

- 2x support frame
- 1x rear wall
- 2x partition wall
- 2x smooth universal shelf
- 1x support tray set with cylinder lock for drawer 700/1300
- 11x drawer

Item no.	Dimensions in mm (WxDxH)
SRK02	749 x 733 x 2030

POSSIBLE MODULE COMBINATIONS

Module 1 Module 2 Module 3 Module 4

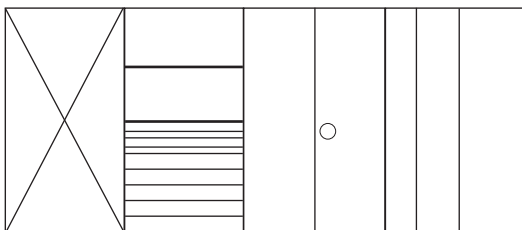

Module 1 Module 3 Module 2 Module 4

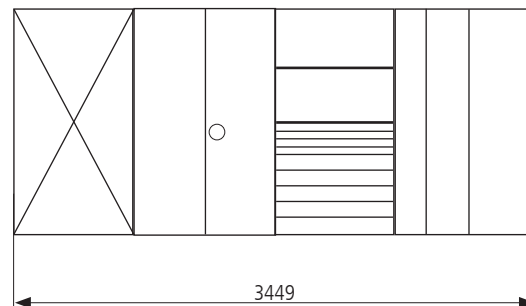

Please note:
Only 1 support frame is required between the individual modules

Example for total length:

5x support frame x 49 mm
 + 2x 651 mm (module 700)
 + 2x 951 mm (module 1000)
 = 3449 mm *Dimensions excluding side end walls*



Module 3 | 1000

- 2x support frame
- 1x rear wall
- 2x partition wall
- 1x hinged door assembly 1000/2000
- 2x universal shelf with height of 56 mm as top and bottom
- 4x shelf with height of 25 mm as intermediate shelf
- 1x fitted shelf

Item no.	Dimensions in mm (WxDxH)
SRK03	1049 x 733 x 2030



Module 4 | 1000

- 2x support frame
- 1x rear wall
- 2x partition wall
- 1x support tray set with cylinder lock for vertical cabinet 1000
- 3x vertical pull-out
- No additional intermediate shelves or perforated walls

Item no.	Dimensions in mm (WxDxH)
SRK04	1049 x 733 x 2030

POSSIBLE MODULE COMBINATIONS

Module 2 Module 4 Module 3 Module 1

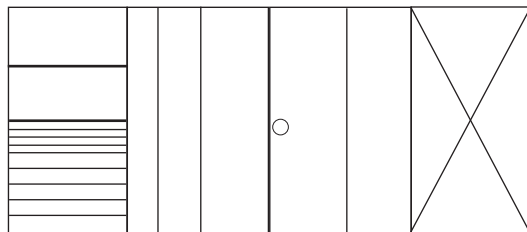

Module 4 Module 3 Module 2 Module 1

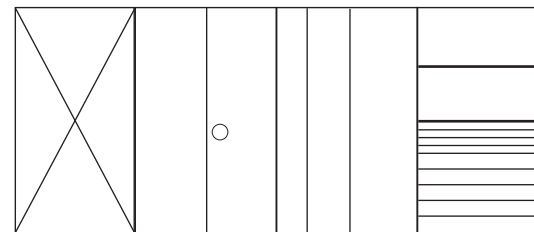

Other combinations are possible

Finished modules

Module 5 – 6

- Delivery unassembled



Module 5 | 1400

- 3x support frame
- 2x rear wall
- 2x side end wall
- 2x partition wall
- 6x smooth universal shelf
- 5x smooth shelf
- 4x shelf side panels
- 1x hinged door assembly 700/2000
- 1x support tray set with cylinder lock for drawer 700/1000
- 7x drawer
- 1x fitted shelf

Item no.	Dimensions in mm (WxDxH)
SRK05	1449 x 733 x 2030

Module 6 | 700

- 2x support frame
- 1x rear wall
- 2x side end wall
- 2x smooth universal shelf
- 2x smooth shelf
- 6x shelf side panels
- 1x hinged door assembly 700/1000, top
- 1x support tray set with cylinder lock for drawer 700/1000
- 7x drawer

Item no.	Dimensions in mm (WxDxH)
SRK06	749 x 733 x 2030



Module 7 | 1000

- 2x support frame
- 1x rear wall
- 2x side end wall
- 4x universal shelf
- 2x shelf
- 2x drawer, not lockable
- 1x hinged door assembly 1000, top
- 1x fitted shelf

Item no.	Dimensions in mm (WxDxH)
SRK07	1049 x 733 x 2030

Module 8 | 1000

- 2x support frame
- 1x rear wall
- 2x side end wall
- 1x support tray set with cylinder lock for vertical pull-out
- 3x vertical pull-out
- 1x shelf
- 2x universal shelf
- 1x Universal shelf, slotted
- 1x fitted shelf

Item no.	Dimensions in mm (WxDxH)
SRK08	1049 x 733 x 2030

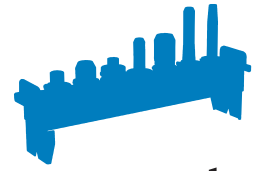

CNC storage and transport systems





CNC modular system

Page 150



CNC tool inserts

Page 152



CNC table mounted frames

Page 154



CNC tool holder carriers

Page 156



CNC cabinets and workbenches

Page 158



Storage of up to
400 inserts

RotaRex® large cabinet

Page 168



CNC workshop and tool trolley

Page 174



CNC storage and transport systems

The modular system

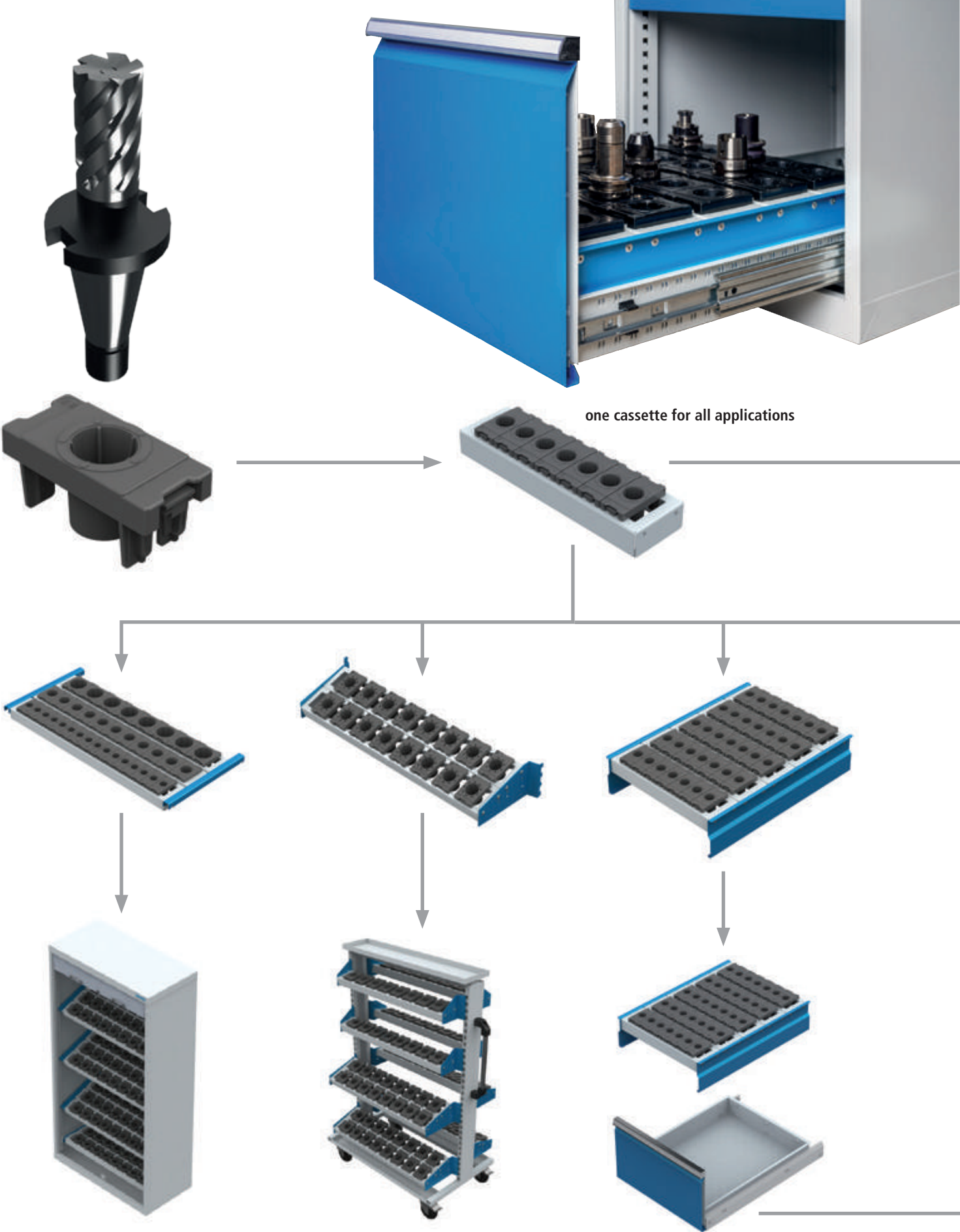

CNC E1 **Tool insert size 1**
Tool insert 49 x 103 x 17 mm

Ergonomics
Efficiency through occupational safety during the activity to be carried out

Mobile
Fast, flexible work process thanks to maximum mobility

CNC E2 **Tool insert size 2**
Tool insert 74 x 103 x 17 mm

Optimisation of the space within reach
Optimal range of movement with short receptacle paths and an unrestricted assembly area

Information
on relevant articles/product groups are shown

CNC E3 **Tool insert size 3**
Tool insert 99 x 103 x 17 mm

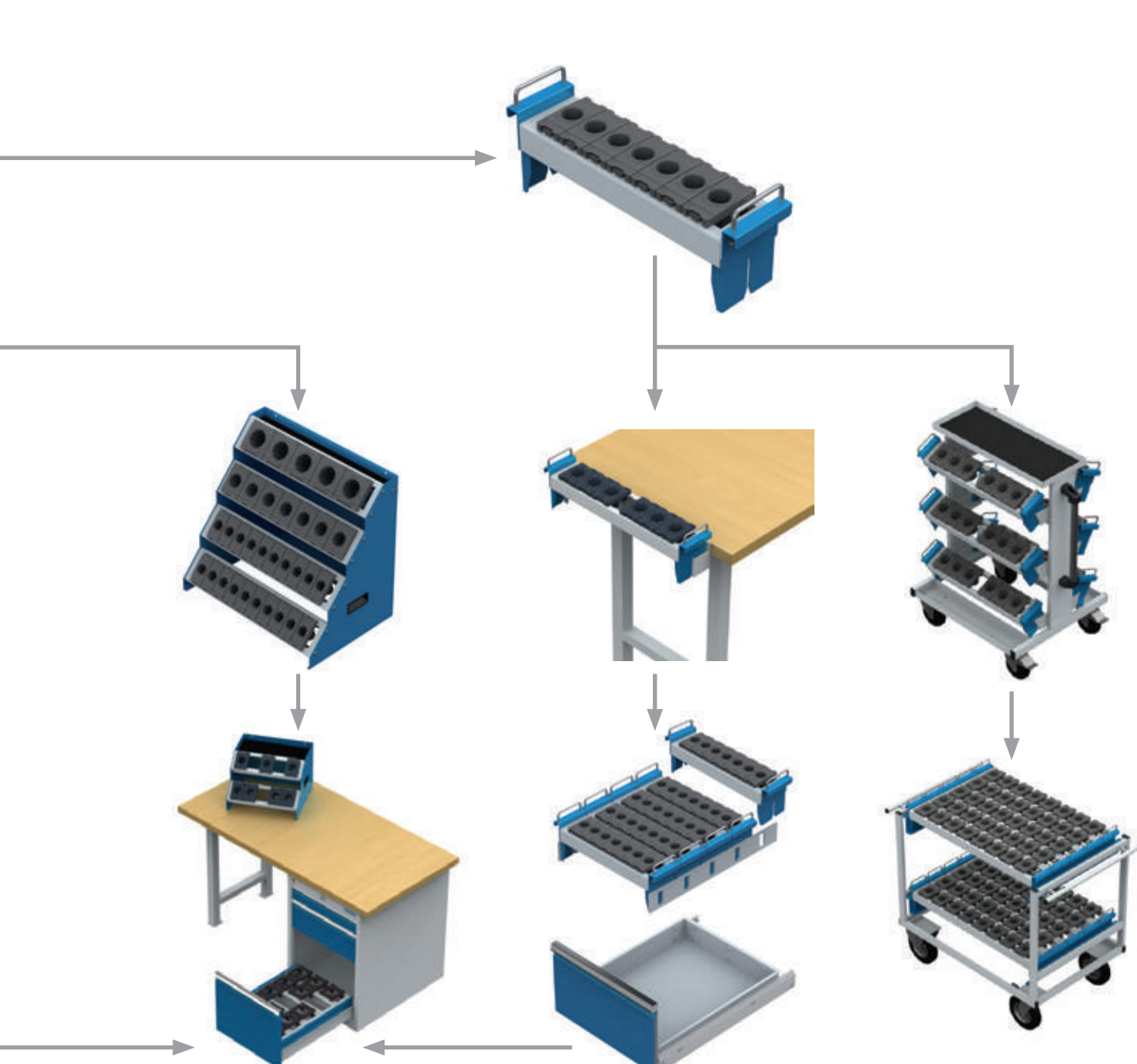

CNC tool inserts

The tool inserts are made of oil-resistant, break-proof and impact-resistant ABS plastic and are noted for their tailored inner struts. The tapered tool holder is thus optimally centred.

- The insert is clicked into our grid system with a clip and can be moved in steps of 25 mm without a tool.
- Nubs on the top of the inserts. In this way, no adhesion occurs and the tool is prevented from attaching itself by vacuum
- All tool sizes can be combined

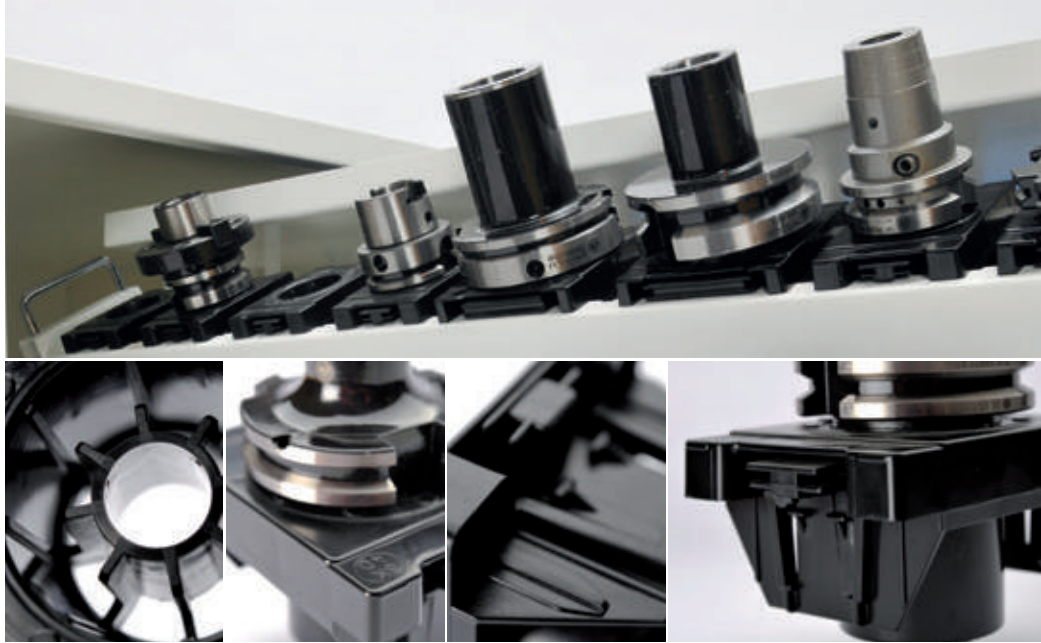

CNC
E1

Item no.	Type
56.01.30	SK 30 / ISO 30
56.02.25	VDI 25
56.02.30	VDI 30
56.03.30	MK 3
56.03.40	MK 4

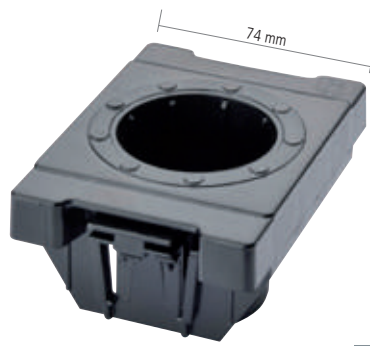

CNC
E2

Item no.	Type
56.01.40	SK 40 / ISO 40
56.02.40	VDI 40
57.01.50	HSK A 50/B 63
57.01.63	HSK A 63/B 80
56.03.50	MK 5



CNC
E3

Item no.	Type
56.01.50	SK 50 / ISO 50
56.02.50	VDI 50
56.02.60	VDI 60
57.01.80	HSK A 80/B 100
57.01.100	HSK A 100/B 125



CNC
E3

Item no.	Type
57.01.40	HSK A 40/B 50



CNC
E3

Item no.	Type
57.01.32	HSK A 32/B 40

Inner struts protect and centre the holders, attachment by vacuum is not possible

Nubs at the top prevent the tool from attaching itself by vacuum

Clip for easy clicking into place – no screwing down

Break-proof, impact-resistant and oil-resistant thanks to ABS material

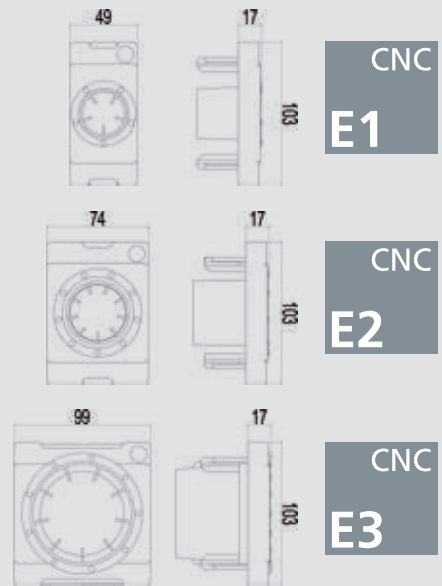
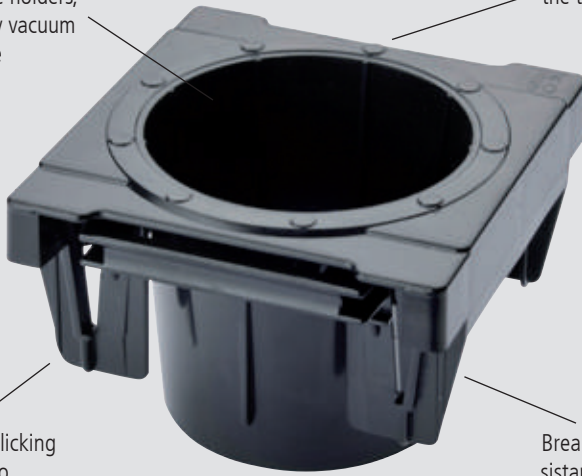

■ With special bore on
On request with surcharge

CNC
E3

Item no.	Type
57.01.00	Universal



CNC
E3

Item no.	Type
57.01.03	Capto C 3

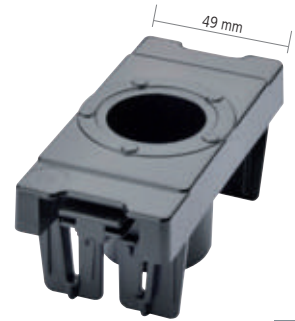

CNC
E1

Item no.	Type
57.01.04	Capto C 4



CNC
E2

Item no.	Type
57.01.05	Capto C 5



CNC
E3

Item no.	Type
57.01.06	Capto C 6

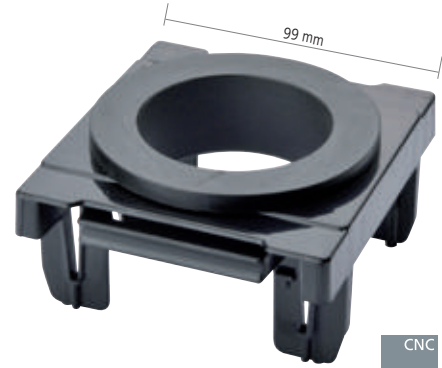

CNC
E3

Item no.	Type
57.01.08	Capto C 8

CNC table mounted frames

CNC table mounted frames (TAG)

- Shelf and handles
- CNC table mounted frames are riveted
- **Supplied without tools and inserts**
- *Number of possible inserts for sizes E1, E2, E3



CNC table mounted frame TAG 2-1

- 2x cassette

Item no.	Dimensions in mm (WxDxH)	CNC E1	CNC E2	CNC E3
02.8705.200	425 x 375 x 300	14*	10*	6*

CNC table mounted frame TAG 2-2

- 2x cassette

Item no.	Dimensions in mm (WxDxH)	CNC E1	CNC E2	CNC E3
02.8707.200	575 x 375 x 300	20*	14*	10*



CNC table mounted frame TAG 4-1

- 4x cassette

Item no.	Dimensions in mm (WxDxH)	CNC E1	CNC E2	CNC E3
02.8705.400	425 x 375 x 525	28*	20*	12*

CNC table mounted frame TAG 4-2

- 4x cassette

Item no.	Dimensions in mm (WxDxH)	CNC E1	CNC E2	CNC E3
02.8707.400	575 x 375 x 525	40*	28*	20*

CNC drawer frame (SR)

- Suitable for 450/600/900 x 600 mm drawers
- CNC drawer frames are riveted
- **Supplied without tools and inserts**
- *Number of possible inserts for sizes E1, E2, E3



CNC drawer frame SR 450 for cabinet R 18-24

Item no.	Dimensions in mm (WxDxH)	CNC E1	CNC E2	CNC E3
02.8705.500	450 x 600 x 130	35*	25*	15*



CNC drawer frame SR 600 for cabinet R 24-24

Item no.	Dimensions in mm (WxDxH)	CNC E1	CNC E2	CNC E3
02.8707.500	600 x 600 x 130	50*	35*	25*



CNC drawer frame SR 900 for cabinet R 36-24

Item no.	Dimensions in mm (WxDxH)	CNC E1	CNC E2	CNC E3
02.8710.500	900 x 600 x 130	80*	55*	40*

CNC tool holder carriers

CNC tool holder carrier (WAT)

- Our modular system offers you a great variety of possibilities
- The cassette is riveted and fitted with grab handles/carry handles
- **Supplied without tools and inserts**
- *Number of possible inserts for sizes E1, E2, E3



CNC tool holder carrier (WAT), 450 for cabinet R 18-24

Item no.	Dimensions in mm (WxDxH)	CNC E1	CNC E2	CNC E3
02.8705.100	470 x 120 x 180	7*	5*	3*



CNC tool holder carrier (WAT), 600 for cabinet R 24-24

Item no.	Dimensions in mm (WxDxH)	CNC E1	CNC E2	CNC E3
02.8707.100	620 x 120 x 180	10*	7*	5*



CNC tool holder carrier (WAT), 800

Item no.	Dimensions in mm (WxDxH)	CNC E1	CNC E2	CNC E3
02.8708.100	820 x 120 x 180	14*	9*	7*



CNC tool holder carrier (WAT), 900 for cabinet R 36-24

Item no.	Dimensions in mm (WxDxH)	CNC E1	CNC E2	CNC E3
02.8710.100	920 x 120 x 180	16*	11*	8*



Suspension rail

- For up to 5 CNC tool holder carriers (WAT)
- For all drawers with 600 mm depth
- Supplied in pairs

Item no.	Dimensions in mm (WxDxH)
02.33.87.60	25 x 600 x 75



Mounting brackets

- For 1 CNC tool holder carrier (WAT)
- Supplied in pairs

Item no.	Dimensions in mm (WxDxH)
02.89.WAT.01	70 x 75 x 88



Aluminium mounting block

- SK 30, SK 40, SK 50
- Other sizes on request

Item no.	Type
02.560.31	SK 30
02.560.41	SK 40
02.560.51	SK 50



New

Steel mounting block

- Swivelling in 5 steps

Item no.	Type	Dimensions in mm (WxDxH)
02.705.30	SK30	125 x 64 x 121
02.705.40	SK40	130 x 64 x 136
02.705.50	SK50	170 x 72 x 170
02.709.25	VDI25	100 x 48 x 97
02.709.30	VDI30	130 x 64 x 121
02.709.40	VDI40	130 x 64 x 136
02.709.50	VDI50	170 x 72 x 170
02.708.32	HSK A 32	100 x 48 x 97
02.708.40	HSK A 40	100 x 48 x 97
02.708.50	HSK A 50	125 x 64 x 121
02.708.63	HSK A 63	130 x 64 x 136
02.708.80	HSK A 80	170 x 72 x 170
02.708.100	HSK A 100	170 x 72 x 170

CNC cabinets and workbenches

CNC combinations from practice R 18-24 | R 24-24

- The CNC drawers of a front height of more than 300 mm are prepared to hold the tool carriers
- 5 tool carriers or 1 drawer frame can be set per drawer
- Tool holder carriers (WAT), drawer frames (SR) and inserts can be found on page 152/153, 155/156
- Lockable with cylinder lock
- Cabinet can be arranged with other drawer front heights
- **Supplied without tools and tool holder frames**

CNC Drawer cabinet R 24-24

- 4x drawer
- Drawers with full pull-out 100 %
- Drawers with 100 mm front height, load capacity 100 kg
- Drawers with 300 and 400 mm front height, load capacity 180 kg
- Usable drawer dimension, internal: 600 x 600 mm

Item no.	Dimensions in mm (WxDxH)
02.140V	705 x 736 x 1019



Note:
Suspension rails on
page 157



CNC inline workbench

- Beech multiplex top 40 mm (H)
- Drawers with full pull-out (FP) 100%
- Drawers with 50 mm front height, load capacity 70 kg
- Drawers with 100, 150, 200 mm front height, load capacity 100 kg
- Drawers with 400 mm front height, load capacity 180 kg
- **Supplied without tool holder carriers (WAT) and drawer frames (SR)**

Item no.	Dimensions in mm (WxDxH)	Designation
580.0111V86	555 x 736 x 819	Left: CNC drawer cabinet R 18-24, 3x drawer Usable drawer dimension, internal: 450 x 600 mm
780.1111V86	705 x 736 x 819	Right: CNC drawer cabinet R 24-24, 4x drawer Usable drawer dimension, internal: 600 x 600 mm
03.15.40	1500 x 750 x 40	Beech multiplex workbench top
03.20.40	2000 x 750 x 40	Beech multiplex workbench top

CNC inline workbench

- Beech multiplex top 1500 x 750 x 40 mm (WxDxH)
- Workbench stand
- Drawer cabinet R 18-24
- 3x drawer
- Drawers with full pull-out 100 %
- Drawers with 100 and 200 mm front height, load capacity 100 kg
- Drawers with 400 mm front height, load capacity 180 kg
- Usable drawer dimension, internal: 450 x 600 mm
- **Supplied without tools, inserts and table mounted frame**

Item no.	Dimensions in mm (WxDxH)
02.580V86	1500 x 750 x 859



Note:
CNC accessories
from page 152/153



CNC box workbench

- Beech multiplex top, 2000 x 750 x 40 mm (WxDxH)
- Drawer cabinets R 24-24
- 7x drawer
- Drawers with full pull-out (FP) 100%
- Drawers with 50 mm front height, load capacity 70 kg
- Drawers with 100 mm front height, load capacity 100 kg
- Drawers with 400 mm front height, load capacity 180 kg
- Usable drawer dimension, internal: 600 x 600 mm
- 2x shelf 500 x 730 x 300 mm (WxDxH)
- incl. levelling feet
- 1000 kg total load capacity
- **Supplied without tools, inserts, drawer frames and tool holder carriers**

Item no.	Dimensions in mm (WxDxH)	Designation
03.20.34V86	2000 x 750 x 859	Left: 3x drawer, usable drawer dimension, internal: 600 x 600 mm Central: 2x shelf, 500 mm Right: 4x drawer, usable drawer dimension, internal: 600 x 600 mm
03.20.34V96	2000 x 750 x 959	Left: 3x drawer, usable drawer dimension, internal: 600 x 600 mm Central: 2x shelf, 500 mm Right: 4x drawer, usable drawer dimension, internal: 600 x 600 mm

CNC cabinets and workbenches

CNC workstation – We offer you the right solution R 18-24 | R 24-24

- Drawers with full pull-out (FP) 100%
- Drawers with 50 mm front height, load capacity 70 kg
Drawers with 100, 150, 200 mm front height, load capacity 100 kg
Drawers with 400 mm front height, load capacity 180 kg
- Supplied without tools, inserts and decoration



Aluminium mounting block
see page 157

Pos.	Item no.	Dimensions in mm (WxDxH)	Description
1	580.0111V86	555 x 736 x 819	CNC drawer cabinet R 18-24 Usable drawer dimension, internal: 450 x 600 mm
2	780.1111V86	705 x 736 x 819	CNC drawer cabinet R 24-24 Usable drawer dimension, internal: 600 x 600 mm
w/ofg.	02.8707.500	600 x 600 x 130	CNC drawer frame SR 600, 600 x 600 x 130 mm (see page 175)
3	03.20.40	2000 x 750 x 40	Beech multiplex workbench top 40 mm
4.1	03.935.125.240	1250	Support column left
4.2	03.935.125.140	1250	Support column right
5	03.983.102	1000 x 20 x 302	Perforated wall for hanging between the support columns
6	02.910.02	942 x 263 x 134	CNC tool holding shelf with 2 x cassettes for hanging between the support columns
7	02.910.01	942 x 147 x 134	CNC tool holding shelf with 1 x cassettes for hanging between the support columns
8	02.89.WAT.01	70 x 75 x 88	Bracket for attaching the CNC carriers to the workbench top
9	02.8707.100	620 x 120 x 180	CNC tool holder carrier for R 24-24
10	02.8705.400	425 x 375 x 525	CNC table mounted frame TAG 4-1
11	05.96.01	–	Work chair with casters, seat and backrest of black PU, safety gas spring, plastic cruciform base, seat and backrest inclination, height 465 - 655 mm



Mobile CNC workbench R 18-24

- Beech multiplex top, 1250 x 750 x 40 mm (WxDxH)
- 7x drawer
- Drawers with full pull-out (FP) 100 %, load capacity 100 kg per drawer
- Drawer with 400 mm front height, load capacity 180 kg per drawer
- Usable drawer dimension, internal: 450 x 600 mm
- Drawer guides on ball-bearings, individual pull-out lock
- Round tube push handle
- 2x fixed and 2x steering caster Ø 200 mm, of which 2 with locks
- *Number of possible inserts for sizes E1, E2, E3

Item no.	Dimensions in mm (WxDxH)
04.12.26V	1250 x 750 x 995

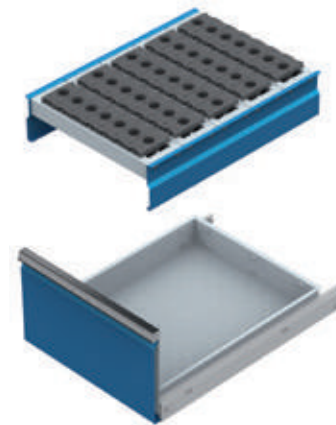

CNC drawer frame SR 450 for the 400 mm drawer

Item no.	Dimensions in mm (WxDxH)	CNC E1	CNC E2	CNC E3
02.8705.500	450 x 600 x 130	35*	25*	15*



Mobile CNC workbench R 18-24

- Beech multiplex top, 1250 x 750 x 40 mm (WxDxH)
- 4x drawer, 1x door
- Drawers with full pull-out (FP) 100 %, load capacity 100 kg per drawer
- Drawer with 400 mm front height, load capacity 180 kg per drawer
- Usable drawer dimension, internal: 450 x 600 mm
- Drawer guides on ball-bearings, individual pull-out lock
- Round tube push handle
- 2x fixed and 2x steering caster Ø 200 mm, of which 2 with locks
- Space for 5x CNC tool holder carrier (WAT), 500
- *Number of possible inserts for sizes E1, E2, E3

Item no.	Dimensions in mm (WxDxH)
04.12.27V	1250 x 750 x 995

Mounting brackets for 1 CNC tool holder carrier (WAT)

- Supplied in pairs



Item no.	Dimensions in mm (WxDxH)
02.89.WAT.01	70 x 75 x 88

Suspension rail for up to 5 x CNC tool holder carriers (WAT)

- Supplied in pairs



Item no.	Dimensions in mm (WxDxH)
02.33.87.60	25 x 600 x 75

CNC tool holder carrier (WAT), 450



Item no.	Dimensions in mm (WxDxH)	CNC E1	CNC E2	CNC E3
02.8705.100	470 x 120 x 180	7*	5*	3*

CNC cabinets and workbenches

CNC combination system R 36-24

- With CNC tool holder frames (WAR) and tool holder carriers (WAT)
- Drawers with full pull-out 100 %
- Drawers with 50 mm front height, load capacity 70 kg
- Drawers with 100 and 150 mm front height, load capacity 100 kg
- Drawers with 400 mm front height, load capacity 180 kg
- **Supplied without tools and inserts**
- *Number of possible inserts for sizes E1, E2, E3



Shelf bracket for roller shutter cabinet and CNC-frame

- 1 piece

CNC roller shutter attachment cabinet (empty)

- Cabinet with plastic roller shutters
- With push cylinder lock

Item no.	Dimensions in mm (WxDxH)
02.98.00	1000 x 500 x 1000

Art.-Nr.
01-00206

1 CNC tool holder frame (WAR) for roller shutter cabinet

- Can be installed straight or inclined
- Load capacity 120 kg

Item no.	Dimensions in mm (WxDxH)
02.89WARG900	950 x 425 x 85

	CNC E1	CNC E2	CNC E3
Maximum insert capacity per carrier	48*	33*	24*

2 CNC tool holder frame (WAR) for roller shutter cabinet, pull-out

- For roller shutter cabinet
- Full pull-out 100 %
- Load capacity 50 kg

Item no.	Dimensions in mm (WxDxH)
02.095.03 VA	950 x 420 x 68

	CNC E1	CNC E2	CNC E3
Maximum insert capacity per carrier	48*	33*	24*

3 CNC drawer cabinet R 36-24

- With cylinder lock
- Usable drawer area, internal: 900 x 600 mm
- 4x drawer
- Drawer with 400 mm BLH without slotted side panels, therefore the use of metal dividers is not possible

Item no.	Dimensions in mm (WxDxH)
02.1080.4V	1005 x 736 x 819



400

CNC drawer frames or single carriers see page 175/176
CNC inserts see page 153/154

CNC tall magazine cabinet

CNC storage and transport systems

- Housing made of sturdy, welded sheet steel
- The possible number of tool frames is based on the tool height and mounting (straight or inclined)
 - Maximum capacity of the **straight** frame: 5
 - Maximum capacity of the **inclined** frame: 4
- *Number of possible inserts for sizes E1, E2, E3

CNC roller shutter cabinet with plastic roller shutters (empty)

- Plastic roller shutters with push cylinder lock

Item no.	Dimensions in mm (WxDxH)
02.95.01	1000 x 500 x 1950

CNC roller shutter cabinet with aluminium roller shutters (empty)

- High-quality aluminium roller shutters with push cylinder lock

Item no.	Dimensions in mm (WxDxH)
02.89.01	1000 x 500 x 1950

1

CNC tool holder frame (WAR)

- Can be installed straight or inclined
- Load capacity 120 kg

Item no.	Dimensions in mm (WxDxH)
02.89WARG900	950 x 425 x 85

	CNC E1	CNC E2	CNC E3
Maximum insert capacity per carrier	48*	33*	24*

2

CNC tool holder frame (WAR) for roller shutter cabinet, pull-out

- For roller shutter cabinet
- Full pull-out 100 %
- Load capacity 50 kg

Item no.	Dimensions in mm (WxDxH)
02.095.03 VA	950 x 420 x 68

	CNC E1	CNC E2	CNC E3
Maximum insert capacity per carrier	48*	33*	24*

3

Shelf for CNC roller shutter cabinet

- Load capacity 100 kg

Item no.	Dimensions in mm (WxDxH)
04.122	950 x 420 x 28

4

Drawer for CNC roller shutter cabinet

- 100 mm front height, full pull-out 100 %
- Load capacity 50 kg
- Usable drawer dimension, internal: 899 x 375 (W x D)

Item no.	Dimensions in mm (WxD)
60.095.100VA	950 x 430



CNC roller shutter cabinet with plastic roller shutters (as shown)

- 2x CNC tool holder frame (WAR), straight/inclined
- 1x CNC tool holder frame (WAR), pull-out
- 1x shelf
- 1x drawer
- **Supplied without tools and inserts**

Item no.	Dimensions in mm (WxDxH)
02.95.01.01	1000 x 500 x 1950



CNC cabinets and workbenches

CNC hinged door cabinet with solid sheet doors R 36-16

- Robust, welded sheet steel construction
- Resistant powder coating
- Drawers with full pull-out 100 %
- Solid sheet doors with moulded recess cylinder lock
- When using drawers and pull-outs, the opening angle must be 130°, therefore these hinged-door wardrobes not be placed directly next to each other.



CNC hinged door cabinet R 36-16

- 1x fixed, inclined tool holder frame (WAR)
- 1x pull-out tool holder frame (WAR)
- 1x shelf
- 3x drawer
- **Supplied without tools and inserts**

Item no.	Dimensions in mm (WxDxH)	Product name	Description
02.118.05.01	980 x 500 x 1838	Hinged door cabinet R 36-16	1x fixed and 1x pull-out tool holder frame (WAR), 1x shelf, without tools and inserts, 3x drawer (100, 150, 200 mm)
02.89WAR900	924 x 425 x 87	CNC tool holder frame (WAR), straight/inclined	Suitable for all hinged door cabinets, can be used straight/inclined, load capacity 80 kg
02.89WARA900	926 x 450 x 60	CNC tool holder frame (WAR), pull-out, for hinged door cabinet	Pull-out 100 %, load capacity 50 kg
04.090.013	925 x 443 x 22	Shelf for hinged door cabinet	Fixed shelf, height-adjustable, load capacity 80 kg
60.098.100VA	900 x 400 x 90	Drawer for hinged door cabinet Front height 100 mm, load capacity 50 kg	Drawer suitable for all hinged door cabinets, pull-out 100 %, internal usable dimension: 900 x 400 mm
60.098.150VA	900 x 400 x 140	Drawer for hinged door cabinet Front height 150 mm, load capacity 50 kg	Drawer suitable for all hinged door cabinets, pull-out 100 %, internal usable dimension: 900 x 400 mm
60.098.200VA	900 x 400 x 190	Drawer for hinged door cabinet Front height 200 mm, load capacity 50 kg	Drawer suitable for all hinged door cabinets, pull-out 100 %, internal usable dimension: 900 x 400 mm

- Robust, welded sheet steel construction
- Resistant powder coating
- Glazed doors with moulded recess cylinder lock
- When using drawers and pull-outs, the opening angle must be 130°, therefore these hinged-door wardrobes not be placed directly next to each other.



CNC hinged door cabinet with glazed doors R 36-16

- 2x fixed, inclined tool holder frame (WAR)
- 2x pull-out tool holder frame (WAR)
- **Supplied without tools and inserts**

Item no.	Dimensions in mm (WxDxH)	Product name	Description
02.117.04.01	980 x 500 x 1838	CNC hinged door cabinet with glazed doors R 36-16	2x fixed and 2x pull-out CNC tool holder frame (WAR), without tools and inserts
04.090.013	925 x 443 x 22	Shelf	Fixed shelf, height-adjustable, load capacity 80 kg
02.89WAR900	924 x 425 x 87	CNC tool holder frame (WAR), straight/inclined	Suitable for all hinged door cabinets, can be used straight/inclined, load capacity 80 kg
02.89WARA900	926 x 450 x 60	CNC tool holder frame (WAR), pull-out	Suitable for all hinged door cabinets, Pull-out 100 %, load capacity 50 kg

CNC inserts see page 153/154

CNC cabinets and workbenches

CNC hinged door cabinet R 36-16

- When using drawers and pull-outs, the opening angle must be 130°, therefore these hinge-door wardrobes cannot be placed directly next to each other.



CNC hinged door cabinet (empty) R 36-16

- Hinged door cabinet with solid sheet doors
- With moulded recess cylinder lock

Item no.	Dimensions in mm (WxDxH)	Usable height in mm
04.109	980 x 500 x 1019	900
04.118	980 x 500 x 1838	1719

CNC hinged door cabinet with glazed doors (empty) R 36-16

- Hinged door cabinet with glazed doors (acrylic glass)
- With moulded recess cylinder lock

Item no.	Dimensions in mm (WxDxH)	Usable height in mm
04.117	980 x 500 x 1838	1719



100 mm front height



150 mm front height

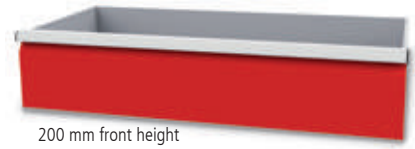

200 mm front height

Drawers for hinged door cabinet R 36-16

- Full pull-out 100 %
- Includes rails and fastening material
- Usable drawer dimension, internal: 900 x 400 mm
- Max. load capacity 50 kg

Item no.	Front height in mm	Shell height in mm	Usable height in mm
60.098.100VA	100	85	90
60.098.150VA	150	135	140
60.098.200VA	200	185	190

New



Pull-out shelf for hinged door cabinet

- Shelf with upstand, pull-out 100 %
- Includes rails and fastening material

Item no.	Dimensions in mm (WxDxH)	Load capacity
04.090.014	926 x 442 x 70	max. 50 kg
04.090.14-75		max. 75 kg



Shelf for hinged door cabinet

- Max. load capacity 80 kg
- Includes fastening material

Item no.	Dimensions in mm (WxDxH)	Designation
04.090.013	925 x 443 x 22	Fixed shelf, height-adjustable, bolted



CNC tool holder frame (WAR) for hinged door cabinet

- Can be used straight/inclined
- Includes fastening material

Item no.	Dimensions in mm (WxDxH)	Load capacity (kg)
02.89WAR900	924 x 425 x 87	80
02.89WAR9005	924 x 425 x 87	140



CNC tool holder frame (WAR) for hinged door cabinet

- Pull-out 100 %
- Includes rails and fastening material

Item no.	Dimensions in mm (WxDxH)	Load capacity (kg)
02.89WARA900	926 x 450 x 60	50

	CNC E1	CNC E2	CNC E3
Maximum insert capacity per carrier for 02.89WAR900 and 02.89WAR9005	48*	33*	24*

	CNC E1	CNC E2	CNC E3
Maximum insert capacity per carrier for 02.89WARA900	48*	33*	24*

Bracket retrofit kit for CNC tool holder frame

- Load capacity 140 kg
- 4-part set



Item no.	Dimensions in mm (WxDxH)
02.89W140	76 x 29 x 12

CNC RotaRex® large cabinet



Your advantages

- Barrier-free access to the cabinet - no impairment by pull-outs
- Space-saving - high quantity of inserts with minimal storage area, up to 400x SK30 or up to 300x SK40 tools fit in 1m²
- Optimised work process as all tools are quickly within reach
- Opening/usable height: 1790 mm
- Forklift base for transport. **Warning!** RotaRex® must not be transported when loaded!

Roller shutters

- The electrically driven roller shutter is operated by remote control
- Alternatively possible with spring-loaded shaft or hinged doors
- Multiple cabinets can be opened simultaneously with one remote control (on request)
- Aluminium-coloured plastic slats
- In case of a power failure or technical defect, emergency unlocking is provided on the rear of the cabinet

Column

- Precision steel tube, Ø 60 mm
- Galvanized
- Total load 1.5 t
- For holding up to 5 CNC rotating frames Individually adjustable on a grid of 25 mm
- Individual readjustment of the column position thanks to a tongue on the bottom



Equipped CNC lathe frames
see page 171



CNC rotating frame

- With handles and locking mechanism
- 16 lines for Tool inserts
- Supplied without inserts

Item no.	Dimensions in mm (Ø)
02.R01	915

CNC-RotaRex® with electric roller shutters

- With remote control
- Without CNC rotating frame

Item no.	Dimensions in mm (WxDxH)
02.1000.1	1055 x 1035 x 2130



CNC-RotaRex® with manual roller shutters

- Without CNC rotating frame

Item no.	Dimensions in mm (WxDxH)
02.1000.2	1055 x 1035 x 2130



CNC-RotaRex® with hinged doors

- Glazed doors with acrylic glass
- Without CNC rotating frame

Item no.	Dimensions in mm (WxDxH)
02.1000.3	1055 x 1035 x 1955

CNC RotaRex® large cabinet

CNC-RotaRex®

Lighting RotaRex®

New

Bring even more clarity to your RotaRex® cabinet.

The self-adhesive lighting set is attached to the inside of the RotaRex® housing and is circumferential. Each storage space is thus optimally illuminated.

The lighting time can be set manually between 30 seconds and 10 minutes. As soon as you open, approach or reach into your storage system, the lighting is activated by the sensor. The lighting is activated by the sensor and gives you a better overview of your tools. Retrofitting is possible.



Lighting set can be flexibly attached



Optimally illuminated tool



Lighting set

- Motion sensor
- LED Stribe warm white, clear coated
- X-adapter for connecting LED Stribes
- Self-adhesive on the back for easy mounting
- Simple plug-in system for easy installation
- Pleasant warm white LED light
- Transparent coating to protect the LED against contact or moisture
- Electrical connection with 230/12V required
- Energy-saving LED technology (saves up to 80 % compared to conventional incandescent lamps)

Item no.	Dimensions in mm (W x D)
02.BELROT	6000 x 10,5

CNC rotating frame only for CNC-RotaRex®

- Dimensions (Ø): 915 mm
- Customer-specific height adjustment thanks to a grid of 25 mm in the column
- Up to 5 x CNC rotating frame fit in the RotaRex®, depending on the tool height
- All frames can be individually rotated 360°
- Maximum load of up to 300 kg per frame
- With handles for optimum access to each tool
- Locking at 90°, 180°, 270°, and 360°
- Smooth rolling with steel ball bearing guides
- **CNC lathe frame only available in combination with a CNC-RotaRex® cabinet available.**

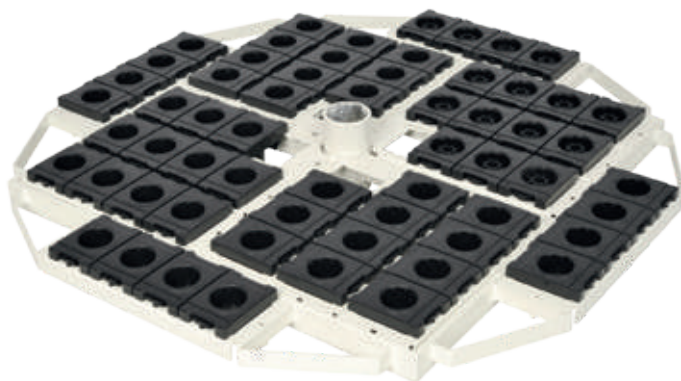

Example: equipped with tool inserts size E2



CNC
E1

Tool insert size 1

- Tool insert 49 x 103 x 17 mm
- CNC rotating frame completely equipped with the inserts listed below
- Only suitable for CNC-RotaRex® cabinet

Item no.	Type	Number of inserts	Number of tools
02.R560130	SK 30	80	80
02.R570104	Capto C4	80	80
02.R560330	MK 3	80	80
02.R560340	MK 4	80	80
02.R560225	VDI 25	80	80
02.R560230	VDI 30	80	80



CNC
E2

Tool insert size 2

- Tool insert 74 x 103 x 17 mm
- CNC rotating frame completely equipped with the inserts listed below
- Only suitable for CNC-RotaRex® cabinet

Item no.	Type	Number of inserts	Number of tools
02.R570150	HSK A 50/B 63	60	60
02.R570163	HSK A 63/B 80	60	60
02.R560140	SK 40	60	60
02.R570405	Capto C5	60	60
02.R560240	VDI 40	60	60
02.R560350	MK5	60	60

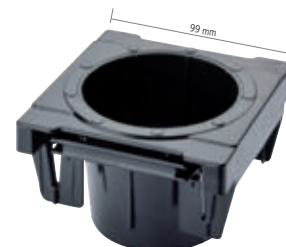

CNC
E3

Tool insert size 3

- Tool insert 99 x 103 x 17 mm
- CNC rotating frame completely equipped with the inserts listed below
- Only suitable for CNC-RotaRex® cabinet

Item no.	Type	Number of inserts	Number of tools
02.R570132	HSK A 32/B 40	32	96
02.R570140	HSK A 40/B 50	32	64
02.R570180	HSK A 80/B 100	32	32
02.R5701100	HSK A 100/B 125	32	32
02.R560150	SK 50	32	32
02.R570103	Capto C3	32	96
02.R570106	Capto C6	32	32
02.R570108	Capto C8	32	32
02.R560250	VDI 50	32	32
02.R570100	Universal	32	32

CNC workshop and transport trolleys

CNC workshop trolley R 18-24 | R 24-24

The optimum storage and safe transport of CNC tools significantly influence economic efficiency.

- Inserts see page 152/153
- **Suspension rails 02.33.87.60 are required when using the single carrier (WAT).**
- **Supplied without tools and inserts**

CNC workshop trolley R18-24

- Raised edges and ribbed rubber mat
- 5x drawer
- Usable drawer dimension, internal: 450 x 600 mm
- Drawers with full pull-out 100 %
- Drawers with 50 mm front height, load capacity 70 kg
Drawers with 100 mm front height, load capacity 100 kg
Drawers with 400 mm front height, load capacity 180 kg
- With individual interlocking
- 2 fixed and 2 steering casters, Ø 125 mm with locks
- Max. load capacity 500 kg

Item no.	Dimensions in mm (WxDxH)	Designation
02.580.05V	555 x 736 x 991	CNC workshop trolley with 5x drawer and raised edges
02.8705.100	470 x 120 x 180	CNC tool holder carrier (WAT), 5x single carrier per drawer possible
02.33.87.60	600 x 25 x 75	Suspension rail for CNC for tool holder carrier (WAT)
02.8705.500	450 x 600 x 130	CNC drawer frame SR 450, without tool inserts



CNC workshop trolley R24-24

- Raised edges and ribbed rubber mat
- 4x drawer
- Usable drawer dimension, internal: 600 x 600 mm
- Drawers with full pull-out 100 %
- Drawers with 50 mm front height, load capacity 70 kg
Drawers with 100 mm front height, load capacity 100 kg
Drawers with 400 mm front height, load capacity 180 kg
- With individual interlocking
- 2 fixed and 2 steering casters, Ø 125 mm with locks
- Max. load capacity 500 kg

Item no.	Dimensions in mm (WxDxH)	Designation
02.780.04V	705 x 736 x 991	CNC workshop trolley with 4 drawer and raised edges
02.8707.100	620 x 120 x 180	CNC tool holder carrier (WAT), 5x single carrier per drawer possible
02.33.87.60	600 x 25 x 75	Suspension rail for CNC for tool holder carrier (WAT)
02.8707.500	600 x 600 x 130	CNC drawer frame SR 600, without tool inserts



- Optimum storage and safe transport
- *Number of possible inserts for sizes E1, E2, E3 see page 152/153



Housing for CNC trolley 02.85.07, R24-24

Item no.	Dimensions in mm (WxDxH)	Description	CNC E1	CNC E2	CNC E3
02.86.07	705 x 736 x 1019	Garage, lockable with cylinder lock			
02.85.07	560 x 630 x 950	CNC trolley with handle, 2x fixed and 2x steering caster, Ø 125 mm with locks, without tool inserts and tool carrier	60*	42*	30*
02.8707.100	620 x 120 x 180	*CNC tool holder carrier (WAT) 600 for R 24-24, 6x single carrier per trolley possible. Capacity see table below.	10*	7*	5*
02.85.08	535 x 336 x 36	Bottom tray for CNC trolley			



Housing for CNC trolley 02.85.01, R36-24

Item no.	Dimensions in mm (WxDxH)	Description	CNC E1	CNC E2	CNC E3
02.86.01	705 x 1003 x 1019	Garage, lockable with cylinder lock			
02.85.01	560 x 930 x 950	CNC trolley with handle, 2x fixed and 2x steering caster, Ø 125 mm with locks, without tool inserts and tool carrier	96*	66*	48*
02.8710.100	920 x 120 x 180	*CNC tool holder carrier (WAT) 900 for R36-24, 6x single carrier per trolley possible. Capacity see table below.	16*	11*	8*
02.85.06	835 x 330 x 36	Bottom tray for CNC trolley			

CNC workshop and transport trolleys

CNC transport trolley

- Optimum storage and safe transport
- **Supplied without tools and inserts**
- *Number of possible inserts for sizes E1, E2, E3 see page 152/153



New



CNC trolley (empty) for max. 8 CNC carriers 02.8707.100

- 2x fixed and 2x steering caster, Ø 125 mm with locks
- Max. capacity of CNC inserts with 8x carrier (see table)
- Max. load capacity 400 kg

Item no.	CNC E1	CNC E2	CNC E3
02.8707.100	10*	7*	5*

Item no.	Dimensions in mm (WxDxH)	CNC E1	CNC E2	CNC E3
02.88.01	480 x 900 x 860	56*	40*	24*
02.88.00	630 x 900 x 860	80*	56*	40*



CNC trolley with 1 level (empty) for CNC tools

- 2x fixed and 2x steering caster, Ø 200 mm with locks
- 1x tool frame, top
- 1x shelf, bottom
- Max. capacity of CNC inserts see table
- Max. load capacity 400 kg

Item no.	Dimensions in mm (WxDxH)	CNC E1	CNC E2	CNC E3
02.092.02	950 x 665 x 950	80*	55*	40*



CNC trolley with 2 levels (empty) for CNC tools

- 2x fixed and 2x steering caster, Ø 200 mm with locks
- 2x tool frame
- Max. capacity of CNC inserts see table
- Max. load capacity 400 kg

Item no.	Dimensions in mm (WxDxH)	CNC E1	CNC E2	CNC E3
02.092.01	950 x 665 x 950	160*	110*	80*

CNC transport trolley

CNC storage and transport systems

- 2x fixed and 2x steering caster, Ø 125 mm with locks
- Ergonomic handle, enabling the multi-trolleys to move extremely smoothly and be used anywhere
- Individual arrangements possible
- Max. load capacity 500 kg
- *Number of possible inserts for sizes E1, E2, E3 see page 152/153



Pos.	Item no.	Dimensions in mm (WxDxH)	Description
1	07.58.10-1	990 x 610 x 1450	CNC trolley (empty) with bottom shelf
2	07.58.22	980 x 200 x 30	Top shelf for CNC trolley
3	02.910.02	942 x 263 x 134	Tool holding shelf, wide, WABg 900 2x cassette with bolted mounting brackets, 0°, 10° & 20° inclinable
4	02.910.01	942 x 147 x 134	Tool holding shelf, narrow, WABk 900 1x cassette with bolted mounting brackets, 0°, 10° & 20° inclinable



Tool holding shelf, single-row

- WABk 900

Item no.	Dimensions in mm (WxDxH)	CNC E1	CNC E2	CNC E3
02.910.01	942 x 147 x 134	16*	11*	8*



Tool holding shelf, double-row

- WABg 900

Item no.	Dimensions in mm (WxDxH)	CNC E1	CNC E2	CNC E3
02.910.02	942 x 263 x 134	32*	22*	16*

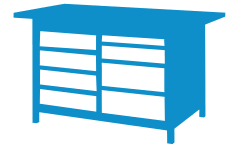

Workbenches





Grid subdivision and locking systems

Page 178



New

Box workbenches T600

Page 184



Box workbenches T750

Page 190



Work tables

Page 214



Inline workbenches

Page 218



New

Other workbenches

Page 230



Workbench accessories

Page 236

Grid subdivision

T500

Series	Series	Series	Series
T500	T500	T500	T500



Housing W x D	Housing W x D	Housing W x D	Housing W x D
380 x 500	530 x 500	680 x 500	980 x 500

Housing height	Usable heights	Usable heights	Usable heights	Usable heights
215	150	–	–	–
365	300*	300*	–	–
465	400*	400*	–	–
469	–	350	–	–
519	–	400	400	–
619	–	500	500	500
719	–	600	600	600
819	–	700	700	700
919	–	800	800	800
1019	–	900	900	900



Drawer W x D	Drawer W x D	Drawer W x D	Drawer W x D
300 x 400	450 x 400	600 x 400	900 x 400









Front height	Shell height	Load capacity	Load capacity	Load capacity	Load capacity
75	59	50 kg	50 kg	50 kg	50 kg
100	85	50 / 75 kg	50 / 75 kg	50 / 75 kg	50 / 75 kg
150	135	50 / 75 kg	50 / 75 kg	50 / 75 kg	50 / 75 kg
200	185	50 / 75 kg	50 / 75 kg	50 / 75 kg	50 / 75 kg
250	185	50 / 75 kg	50 / 75 kg	50 / 75 kg	50 / 75 kg
300	185	50 / 75 kg	50 / 75 kg	50 / 75 kg	50 / 75 kg



Series	Series	Series	Series
T500	T500	T500	T500
T500 12-16	T500 18-16	T500 24-16	T500 36-16

Grid:	R 12-16	R 18-16	R 24-16	R 36-16
-------	---------	---------	---------	---------

* Hanging drawer block, bottom open
All dimensions in mm

		Series	Series	Series	Series
		T736	T736	T736	T736
					
		Housing W x D	Housing W x D	Housing W x D	Housing W x D
		555 x 736	705 x 736	1005 x 736	1305 x 736
Housing height	Usable heights		Usable heights	Usable heights	Usable heights
208	150*				
215	150*				
358	300*		300		
365	300*				
465	400*				
519	400		400	400	–
619	500		500	500	–
719	600		600	600	–
819	700		700	700	700
919	800		800	800	800
1019	900		900	900	900
					
		Drawer W x D	Drawer W x D	Drawer W x D	Drawer W x D
		450 x 600	600 x 600	900 x 600	1200 x 600
Front height	Shell height	Load capacity	Load capacity	Load capacity	Load capacity
50	28	70 kg	70 kg	70 kg	–
75	56	100 kg	100 kg	100 kg	100 kg
100	81	100 / 180 kg	100 / 180 kg	100 / 180 kg	180 kg
125	81	100 / 180 kg	100 / 180 kg	100 / 180 kg	180 kg
150	131	100 / 180 kg	100 / 180 kg	100 / 180 kg	180 kg
175	131	100 / 180 kg	100 / 180 kg	100 / 180 kg	180 kg
200	181	100 / 180 / 300 kg	100 / 180 / 300 kg	100 / 180 / 300 kg	180 kg
250	181	100 / 180 / 300 kg	100 / 180 / 300 kg	100 / 180 / 300 kg	180 kg
300	181	100 / 180 / 300 kg	100 / 180 / 300 kg	100 / 180 / 300 kg	–
400	81	100 / 180 kg	100 / 180 kg	100 / 180 kg	–
		Series	Series	Series	Series
		T736	T736	T736	T736
		T736 18-24	T736 24-24	T736 36-24	T736 48-24
Grid:	R 18-24		R 24-24	R 36-24	R 48-24



* Hanging drawer block, bottom open
All dimensions in mm



Please note!

To set up an e-lock, you need the key management in the form of the management key and the programming key.

More information
see page 120

Pin code E-lock

The pin code e-lock can be opened with a 4-7 digit numerical code. The programming of the users and their pin codes is done by means of administration and programming keys.



Video Pin code E-lock

- Key is replaced with numerical code
- Lever mechanism
- Management with management and programming key
- Lock housing made entirely of steel
- Inlet mounting
- Rotation angle 90° or 180°
- Opening and closing by turning the knob
- Operation via buttons; management with electronic keys
- Emergency power supply via management key
- Surface finish: brushed nickel
- Horizontal alignment
- Vertical orientation for vertical pull-outs (MRS®)

Technical data recessed lock

- Locking with a 4-7 digit numerical code
- Protection class IP55
- Power supply via 2x AAA batteries
- Dimensions (W x D x H): 105.17mm x 2.7mm x 29.57 mm (incl. knob 9.75mm)
- 2 years warranty

Technical data surface-mounted lock (retrofitting)

- Locking with a 4-7 digit numerical code
- Protection class IP55
- Power supply via 2 x lithium batteries CR2450
- Dimensions (W x D x H): 133 mm x 31.5 mm x 20.4mm (incl. knob depth 7.7mm)
- 2 years warranty



Pin code E-lock

Item no.	Lock variant
01PINSLEIN	Pin code E-lock 180° locking, recessed built-in (cannot be retrofitted)
01PINSLAUF	Pin code E-lock 180° locking, surface-mounted (retrofittable)
01PINSLEINZ	Pin code E-lock 90° for single drawer recessed fitted
01PINFLRE	Pin code E-lock hinged right for hinged door
01PINFLLI	Pin code E-lock hinged left for hinged door
01PINFL2	Pin code E-lock for double wing door





Please note!

To set up an e-lock, you need the key management in the form of the management key and the programming key.

RFID E-lock

The RFID e-lock can be opened with an RFID card or a chip. The programming of the locks is done by means of management and programming keys.



Video RFID E-lock

- Key or numerical code is replaced with RFID
- Lever mechanism
- Management with management and programming key
- Operation via RFID
- Inlet mounting
- Rotation angle 90° or 180°
- Opening and closing by turning the knob
- 4 x AA batteries; protection class IP55
- Emergency power supply via management key
- Housing made entirely of metal
- Surface finish: brushed nickel
- Horizontal alignment
- Vertical orientation for vertical pull-outs (MRS®)

Technical data recessed lock

- Closure with RFID standards: iClass and Mifare (13.56 MHz)
ISO 14443A - ISO 14443B - ISO 15693
- Protection class IP55
- Power supply via 4 x AA batteries
- Dimensions (W x D x H): 105.17mm x 2.7mm x 29.57 mm
(incl. knob 9.75mm)
- 2 years warranty

Technical data surface-mounted lock (retrofitting)

- Closure with RFID standards: iClass and Mifare (13.56 MHz)
ISO 14443A - ISO 14443B - ISO 15693
- Protection class IP55
- Power supply via 4 x AA batteries
- Dimensions (W x D x H): 133 mm x 31.5 mm x 20.4 mm
(incl. knob depth 7.7 mm)
- 2 years warranty



RFID E-Lock

Item no.	Lock variant	
01RFIDSLEIN	RFID e-lock 180° locking, recessed built-in (cannot be retrofitted)	
01RFIDSLAUF	RFID e-lock 180° locking, fitted on top (can be retrofitted)	
01RFIDSLEINZ	RFID e-lock 90° for single drawer recessed built-in	
01RFIDFLRE	RFID E-lock hinged right for hinged door	
01RFIDFLLI	RFID E-lock hinged left for hinged door	
01RFIDFL2	RFID e-lock for double wing door	

Box workbenches



- No unassembled goods - complete assembly at the factory
- Construction made of 40 x 40 x 2 mm square tube
- Housing made from high-quality thin sheet metal, frame 1.5 mm thick
- **workbenches with a maximum load of up to 1 t**
- Secure central locking, combination locking systems are possible
- Drawers with ball-bearing guides
- Recessed drawers and doors, therefore no risk of injury due to protruding handle bars
- Worktop made of beech multiplex, glue laminated, oiled, water-repellent
- Levelling glides under the feet

Higher
usable height

Depth 600 mm

Quick info		
Worktop	Beech multiplex	40 mm
Drawers	Usable height	600 mm
	Full pull-out	100 %
	Single pull-out lock	Yes
	Load capacity	50 / 75 kg
	Ball-bearing guides	Yes
Grid	R 18-16 and R 24-16	
Lock	Cylinder lock with two keys	Yes
	Master key capable	Yes

General dimensions	
Work height	859/959 mm + HA 200 or 300 mm possible
Worktop depth	600 mm
Drawer heights	75, 100, 150, 200, 250, 300 mm
Internal drawer height	Front height minus 10 mm
Drawer (W x D)	450 x 400 mm, 600 x 400 mm

Choose from our extensive range of colours. Combinations are possible without extra charge. When placing your order, please indicate the desired colour/colour combination. 1st colour = body colour, 2nd colour = front colour Our standard colours can be found on page 27

Depth 750 mm

Quick info		
Worktop	Beech multiplex	40 mm
Drawers	Usable height	600 mm
	Full pull-out	100 %
	Single pull-out lock	Yes
	Load capacity	70 – 300 kg
	Ball-bearing guides	Yes
Grid	R 18-24 and R 24-24	
Lock	Cylinder lock with two keys	Yes
	Master key capable	Yes

General dimensions	
Work height	859/959 mm + HA 200 or 300 mm possible
Worktop depth	750 mm
Drawer heights	50, 75, 100, 125, 150, 175, 200, 250, 300, 400 mm
Internal drawer height	Front height minus 17 mm
Drawer (W x D)	450 x 600 mm, 600 x 600 mm

Choose from our extensive range of colours. Combinations are possible without extra charge. When placing your order, please indicate the desired colour/colour combination. 1st colour = body colour, 2nd colour = front colour Our standard colours can be found on page 27

Box workbenches

Grid: R 12-14 R 24-12 R 24-16 R 12-16 **R 18-16** R 24-16 R 36-16 R 18-24 R 24-24 R 36-24 R 48-24

Box workbenches 1250| Depth 600 mm

- Drawer interior dimension 450 x 400 mm
- Ball bearing guides
- Full pull-out (FP) 100 %
- Load capacity either 50 kg or 75 kg
- **Only a load capacity of 50 kg is possible for drawers with a front height of 75 mm**
- Beech multiplex workbench top, 1250 x 600 x 40 mm
- Levelling feet
- Cylinder lock with two keys
- Working height 859 mm
- 1000 kg total load capacity

Suitable divider material for the R 18-16 can be found on page 51



Higher usable height



- Left: 3 x Drawer
- Right: 3 x Drawer

Item no.	Dimensions in mm (WxDxH)	Load capacity
03T512H60150	1250 x 600 x 859	50 kg
03T512H60175		75 kg

Individual arrangement

Workbench with 2x empty housing, usable height 600 mm

- Incl. beech multiplex worktop 40 mm

Item no.	Dimensions in mm (WxDxH)
03T5125H6.00	1250 x 600 x 859



Hinged doors

Item no.	Usable heights (mm)	Width (mm)
01.053.450E	450	495
01.053.600E	600	495

- 450 x 400 mm (W x D) with full pull-out 100%
- Only a load capacity of 50 kg is possible for drawers with a front height of 75 mm

Item no.	Front height in mm	Shell height in mm	Usable height in mm	Load capacity
60.046.075VA	75	59	60	50 kg
60.046.100VA	100	85	90	50 kg
60.046.150VA	150	135	140	50 kg
60.046.200VA	200	185	190	50 kg
60.046.250VA	250	185	240	50 kg
60.046.300VA	300	185	290	50 kg
60.046.100VA-75	100	85	90	75 kg
60.046.150VA-75	150	135	140	75 kg
60.046.200VA-75	200	185	190	75 kg
60.046.250VA-75	250	185	240	75 kg
60.046.300VA-75	300	185	290	75 kg

Shelf

Item no.	Dimensions in mm (WxDxH)
04.053.013	475 x 443 x 22

Height adjustment of 200 mm

Item no.	Grid
03.15.95	25 mm



- Left: 4 x Drawer
- Right: 4 x Drawer

Item no.	Dimensions in mm (WxDxH)	Load capacity
03T512H60250	1250 x 600 x 859	50 kg
03T512H60275		75 kg



- Left: 4 x Drawer
- Right: 3 x Drawer

Item no.	Dimensions in mm (WxDxH)	Load capacity
03T512H60350	1250 x 600 x 859	50 kg
03T512H60375		75 kg



- Left: 1 x Drawer, 1 x Hinged door
- Right: 1 x Drawer, 1 x Hinged door

Item no.	Dimensions in mm (WxDxH)	Load capacity
03T512H60450	1250 x 600 x 859	50 kg
03T512H60475		75 kg



- Left: 3 x Drawer
- Right: 1 x Hinged door, 1x shelf

Item no.	Dimensions in mm (WxDxH)	Load capacity
03T512H60550	1250 x 600 x 859	50 kg
03T512H60575		75 kg



- Left: 5 x Drawer
- Right: 5 x Drawer
- *Only a load capacity of 50 kg is possible for drawers with a front height of 75 mm

Item no.	Dimensions in mm (WxDxH)	Load capacity
03T512H60650	1250 x 600 x 859	50 kg
03T512H60675		75 kg



- Left: 4 x Drawer
- Right: 4 x Drawer

Item no.	Dimensions in mm (WxDxH)	Load capacity
03T512H60750	1250 x 600 x 859	50 kg
03T512H60775		75 kg

Box workbenches

Grid: R 12-14 R 24-12 R 24-16 R 12-16 R 18-16 **R 24-16** R 36-16 R 18-24 R 24-24 R 36-24 R 48-24

Box workbenches 1500 | Depth 600 mm

- Drawer interior dimension 600 x 400 mm
- Ball bearing guides
- Full pull-out (FP) 100 %
- Load capacity either 50 kg or 75 kg
- **Only a load capacity of 50 kg is possible for drawers with a front height of 75 mm**
- Beech multiplex workbench top, 1500 x 600 x 40 mm
- Levelling feet
- Cylinder lock with two keys
- Working height 859 mm
- 1000 kg total load capacity

Suitable divider material for the R 24-16 can be found on page 57



Higher usable height



- Left: 4 x Drawer
- Right: 4 x Drawer

Item no.	Dimensions in mm (WxDxH)	Load capacity
03T515H60150	1500 x 600 x 859	50 kg
03T515H60175		75 kg

Individual arrangement

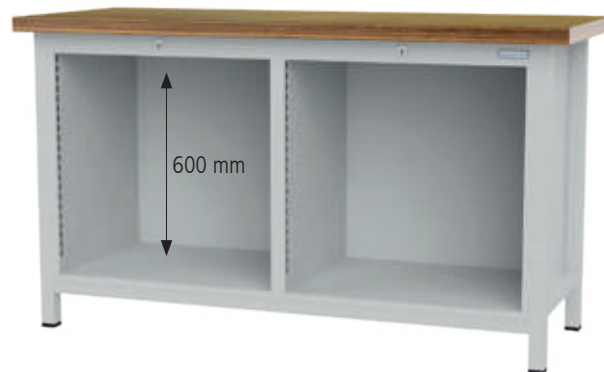

Workbench with 2x empty housing, usable height 600 mm

- Incl. beech multiplex worktop 40 mm

Item no.	Dimensions in mm (WxDxH)
03T515H6.00	1500 x 600 x 859

Hinged doors

Item no.	Usable heights (mm)	Width (mm)
01.068.450E	450	645
01.068.600E	600	645

Shelf

Item no.	Dimensions in mm (WxDxH)
04.060.013	625 x 443 x 22

Height adjustment of 200 mm

Item no.	Raster
03.15.95	25 mm

- 600 x 400 mm (W x D) with full pull-out 100%
- Only a load capacity of 50 kg is possible for drawers with a front height of 75 mm

Item no.	Front height in mm	Shell height in mm	Usable height in mm	Load capacity
60.068.075VA	75	59	60	50 kg
60.068.100VA	100	85	90	50 kg
60.068.150VA	150	135	140	50 kg
60.068.200VA	200	185	190	50 kg
60.068.250VA	250	185	240	50 kg
60.068.300VA	300	185	290	50 kg
60.068.100VA-75	100	85	90	75 kg
60.068.150VA-75	150	135	140	75 kg
60.068.200VA-75	200	185	190	75 kg
60.068.250VA-75	250	185	240	75 kg
60.068.300VA-75	300	185	290	75 kg



- Left: 4 x Drawer
- Right: 4 x Drawer

Item no.	Dimensions in mm (WxDxH)	Load capacity
03T515H60250	1500 x 600 x 859	50 kg
03T515H60275		75 kg



- Left: 4 x Drawer
- Right: 1 x Drawer, 1 x Hinged door

Item no.	Dimensions in mm (WxDxH)	Load capacity
03T515H60350	1500 x 600 x 859	50 kg
03T515H60375		75 kg



- Left: 1 x Drawer, 1 x Hinged door
- Right: 1 x Drawer, 1 x Hinged door

Item no.	Dimensions in mm (WxDxH)	Load capacity
03T515H60450	1500 x 600 x 859	50 kg
03T515H60475		75 kg



- Left: 3 x Drawer
- Right: 3 x Drawer

Item no.	Dimensions in mm (WxDxH)	Load capacity
03T515H60550	1500 x 600 x 859	50 kg
03T515H60575		75 kg



- Left: 4 x Drawer
- Right: 4 x Drawer
- *Only a load capacity of 50 kg is possible for drawers with a front height of 75 mm

Item no.	Dimensions in mm (WxDxH)	Load capacity
03T515H60650	1500 x 600 x 859	50 kg
03T515H60675		75 kg



- Left: 5 x Drawer
- Right: 4 x Drawer
- *Only a load capacity of 50 kg is possible for drawers with a front height of 75 mm

Item no.	Dimensions in mm (WxDxH)	Load capacity
03T515H60750	1500 x 600 x 859	50 kg
03T515H60775		75 kg

Box workbenches

Grid: R 12-14 R 24-12 R 24-16 R 12-16 **R 18-16 R 24-16** R 36-16 R 18-24 R 24-24 R 36-24 R 48-24

Box workbenches 2000 | Depth 600 mm



- Drawer interior dimension 450/600 x 400 mm
- Ball bearing guides
- Full pull-out (FP) 100 %
- Load capacity either 50 kg or 75 kg
- **Only a load capacity of 50 kg is possible for drawers with a front height of 75 mm**
- Beech multiplex workbench top, 2000 x 600 x 40 mm
- Levelling feet
- Cylinder lock with two keys
- Working height 859 mm
- 1000 kg total load capacity

Suitable divider material for the R 18-16 can be found on page 51

Higher usable height

Individual arrangement

R 18-16

R 24-16

R 18-16

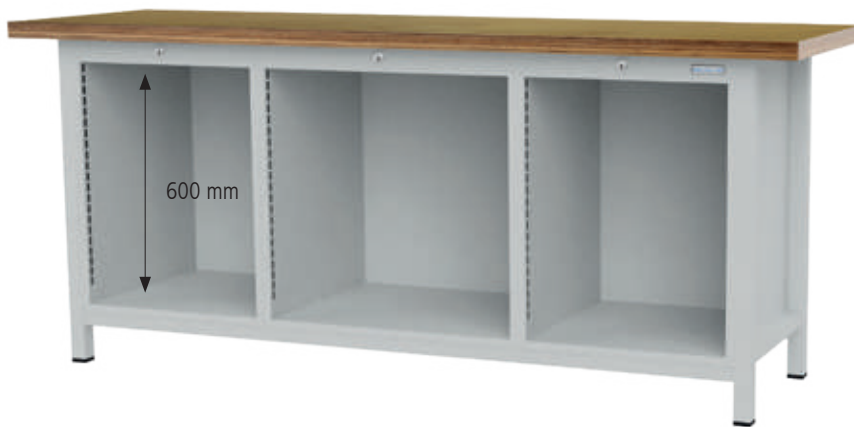

Workbench with 3x empty housing, usable height 600 mm

- Incl. beech multiplex worktop 40 mm

Item no.	Dimensions in mm (WxDxH)
03T520H6.00	2000 x 600 x 859

- 450 x 400 mm (B x T) mit Vollauszug 100%
- Only a load capacity of 50 kg is possible for drawers with a front height of 75 mm

Item no.	Front height in mm	Shell height in mm	Usable height in mm	Load capacity
60.046.075VA	75	59	60	50 kg
60.046.100VA	100	85	90	50 kg
60.046.150VA	150	135	140	50 kg
60.046.200VA	200	185	190	50 kg
60.046.250VA	250	185	240	50 kg
60.046.300VA	300	185	290	50 kg
60.046.100VA-75	100	85	90	75 kg
60.046.150VA-75	150	135	140	75 kg
60.046.200VA-75	200	185	190	75 kg
60.046.250VA-75	250	185	240	75 kg
60.046.300VA-75	300	185	290	75 kg

Hinged doors R 18-16

Item no.	Usable heights (mm)	Width (mm)
01.053.450E	450	495
01.053.600E	600	495

Hinged doors R 24-16

Item no.	Usable heights (mm)	Width (mm)
01.068.450E	450	645
01.068.600E	600	645

Shelf R 18-16

Item no.	Dimensions in mm (WxDxH)
04.053.013	475 x 443 x 22

Shelf R 24-16

Item no.	Dimensions in mm (WxDxH)
04.060.013	625 x 443 x 22

Height adjustment of 200 mm

Item no.	Grid
03.15.95	25 mm

- 600 x 400 mm (W x D) with full pull-out 100%
- Only a load capacity of 50 kg is possible for drawers with a front height of 75 mm

Item no.
60.068.075VA
60.068.100VA
60.068.150VA
60.068.200VA
60.068.250VA
60.068.300VA
60.068.100VA-75
60.068.150VA-75
60.068.200VA-75
60.068.250VA-75
60.068.300VA-75

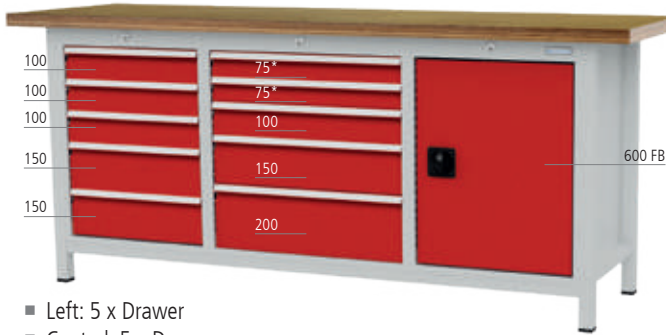

- Left: 5 x Drawer
- Central: 5 x Drawer
- Right: 1 x Hinged door, 1 x Shelf
- *Only a load capacity of 50 kg is possible for drawers with a front height of 75 mm

Item no.	Dimensions in mm (WxDxH)	Load capacity
03T520H60250	2000 x 600 x 859	50 kg
03T520H60275		75 kg



- Left: 1 x Drawer, 1 x Hinged door
- Central: 4 x Drawer
- Right: 4 x Drawer

Item no.	Dimensions in mm (WxDxH)	Load capacity
03T520H60350	2000 x 600 x 859	50 kg
03T520H60375		75 kg



- Left: 3 x Drawer
- Central: 3 x Drawer
- Right: 3 x Drawer

Item no.	Dimensions in mm (WxDxH)	Load capacity
03T520H60450	2000 x 600 x 859	50 kg
03T520H60475		75 kg



- Left: 1 x Drawer, 1 x Hinged door
- Central: 5 x Drawer
- Right: 1 x Drawer, 1 x Hinged door
- *Only a load capacity of 50 kg is possible for drawers with a front height of 75 mm

Item no.	Dimensions in mm (WxDxH)	Load capacity
03T520H60550	2000 x 600 x 859	50 kg
03T520H60575		75 kg



- Left: 3 x Drawer
- Central: 4 x Drawer
- Right: 5 x Drawer
- *Only a load capacity of 50 kg is possible for drawers with a front height of 75 mm

Item no.	Dimensions in mm (WxDxH)	Load capacity
03T520H60650	2000 x 600 x 859	50 kg
03T520H60675		75 kg



- Left: 6 x Drawer
- Central: 4 x Drawer
- Right: 3 x Drawer

Item no.	Dimensions in mm (WxDxH)	Load capacity
03T520H60750	2000 x 600 x 859	50 kg
03T520H60775		75 kg

Box workbenches

Grid: R 12-14 R 24-12 R 24-16 R 12-16 R 18-16 R 24-16 R 36-16 **R 18-24** R 24-24 R 36-24 R 48-24

Box workbenches 810 | Depth 750 mm

- Drawer interior dimension 450 x 600 mm
- Drawers with full pull-out (FP) 100%
- Drawers with 50 mm front height, load capacity 70 kg
Drawers from 75 mm front height, load capacity 100 kg
Load capacity 180 kg on request
- Beech multiplex workbench top, 810 x 750 x 40 mm
- Levelling feet
- Cylinder lock with two keys
- Working height 859 mm or 959 mm
- 1000 kg total load capacity

Suitable divider material for the R 18-24 can be found on page 75



■ 3x drawer

Item no.	Dimensions in mm (WxDxH)
03.055.05V	810 x 750 x 859
03.055.05V9	810 x 750 x 959



■ 2x drawer, 1x hinged door

Item no.	Dimensions in mm (WxDxH)
03.055.01V	810 x 750 x 859
03.055.01V9	810 x 750 x 959



■ 5x drawer

Item no.	Dimensions in mm (WxDxH)
03.055.06V	810 x 750 x 859
03.055.06V9	810 x 750 x 959

Individual arrangement

Workbench with empty housing Usable height 600 mm

- Incl. beech multiplex worktop 40 mm

Item no.	Dimensions in mm (WxDxH)
03.055.001	810 x 750 x 859
03.055.001-9	810 x 750 x 959



Hinged doors

- Usable width 495 mm

Item no.	Version	Usable heights (mm)
03.050.450L	left	450
03.050.450R	right	450
03.050.600	left+right	600

Shelf

Item no.	Dimensions in mm (WxDxH)
03.1094.01	499 x 705 x 20

Height adjustment of 200 mm

Item no.	Grid
03.15.95	25 mm

- 450 x 600 mm (W x D) with full pull-out 100% - drawers with 50 mm front height: load capacity 70 kg; drawers from 75 mm front height: load capacity 100 kg



Item no.	Front height (mm)	Shell height (mm)	Usable heights (mm)
60.50.050V07	50	28	30
60.50.075V10	75	56	58
60.50.100V10	100	81	83
60.50.125V10	125	81	108
60.50.150V10	150	131	133
60.50.175V10	175	131	158
60.50.200V10	200	181	183
60.50.250V10	250	181	233
60.50.300V10	300	181	283



600 FB

- 1x hinged door
- 1x shelf

Item no.	Dimensions in mm (WxDxH)
03.055.07V	810 x 750 x 859
03.055.07V9	810 x 750 x 959



50
100
450

- 2x drawer
- 1x hinged door

Item no.	Dimensions in mm (WxDxH)
03.055.12V	810 x 750 x 859
03.055.12V9	810 x 750 x 959



50
50
50
450

- 3x drawer
- 1x hinged door

Item no.	Dimensions in mm (WxDxH)
03.055.08V	810 x 750 x 859
03.055.08V9	810 x 750 x 959



100
100
100
100
100
100

- 6x drawer

Item no.	Dimensions in mm (WxDxH)
03.055.09V	810 x 750 x 859
03.055.09V9	810 x 750 x 959



200
200
200

- 3x drawer

Item no.	Dimensions in mm (WxDxH)
03.055.10V	810 x 750 x 859
03.055.10V9	810 x 750 x 959



300
300

- 2x drawer

Item no.	Dimensions in mm (WxDxH)
03.055.11V	810 x 750 x 859
03.055.11V9	810 x 750 x 959

Box workbenches

Grid: R 12-14 R 24-12 R 24-16 R 12-16 R 18-16 R 24-16 R 36-16 R 18-24 **R 24-24** R 36-24 R 48-24

Box workbenches 810 | Depth 750 mm

- Drawer interior dimension 600 x 600 mm
- Drawers with full pull-out (FP) 100%
- Drawers with 50 mm front height, load capacity 70 kg
Drawers from 75 mm front height, load capacity 100 kg
Load capacity 180 kg on request
- Beech multiplex workbench top, 810 x 750 x 40 mm
- Levelling feet
- Cylinder lock with two keys
- Working height 859 mm or 959 mm
- 1000 kg total load capacity

Suitable divider material for the R 24-24 can be found on page 83



- 1x hinged door, 1x shelf

Item no.	Dimensions in mm (WxDxH)
03.075.01V	810 x 750 x 859
03.075.01V9	810 x 750 x 959



- 2x drawer, 1x hinged door

Item no.	Dimensions in mm (WxDxH)
03.075.03V	810 x 750 x 859
03.075.03V9	810 x 750 x 959



- 5x drawer

Item no.	Dimensions in mm (WxDxH)
03.075.06V	810 x 750 x 859
03.075.06V9	810 x 750 x 959

Individual arrangement

Workbench with empty housing, usable height 600 mm

- Incl. beech multiplex worktop 40 mm

Item no.	Dimensions in mm (WxDxH)
03.075.001	810 x 750 x 859
03.075.001-9	810 x 750 x 959



Hinged doors

- Usable width 645 mm

Item no.	Version	Usable heights (mm)
03.070.450L	left	450
03.070.450R	right	450
03.070.600	left+right	600

Shelf

Item no.	Dimensions in mm (WxDxH)
03.1094.00	649 x 705 x 20

Height adjustment of 200 mm

Item no.	Grid
03.15.95	25 mm

- 600 x 600 mm (W x D) with full pull-out 100% - drawers with 50 mm front height: load capacity 70 kg; drawers from 75 mm front height: load capacity 100 kg



Item no.	Front height (mm)	Shell height (mm)	Usable heights (mm)
60.70.050V07	50	28	30
60.70.075V10	75	56	58
60.70.100V10	100	81	83
60.70.125V10	125	81	108
60.70.150V10	150	131	133
60.70.175V10	175	131	158
60.70.200V10	200	181	183
60.70.250V10	250	181	233
60.70.300V10	300	181	283



- 2x drawer
- 1x hinged door

Item no.	Dimensions in mm (WxDxH)
03.075.12V	810 x 750 x 859
03.075.12V9	810 x 750 x 959



- 3x drawer
- 1x hinged door

Item no.	Dimensions in mm (WxDxH)
03.075.08V	810 x 750 x 859
03.075.08V9	810 x 750 x 959



- 3x drawer

Item no.	Dimensions in mm (WxDxH)
03.075.05V	810 x 750 x 859
03.075.05V9	810 x 750 x 959



- 6x drawer

Item no.	Dimensions in mm (WxDxH)
03.075.09V	810 x 750 x 859
03.075.09V9	810 x 750 x 959



- 3x drawer

Item no.	Dimensions in mm (WxDxH)
03.075.10V	810 x 750 x 859
03.075.10V9	810 x 750 x 959



- 2x drawer

Item no.	Dimensions in mm (WxDxH)
03.075.11V	810 x 750 x 859
03.075.11V9	810 x 750 x 959

Box workbenches

Grid: R 12-14 R 24-12 R 24-16 R 12-16 R 18-16 R 24-16 R 36-16 **R 18-24** R 24-24 R 36-24 R 48-24

Box workbenches 1250 | Depth 750 mm

- Drawer interior dimension 450 x 600 mm
- Drawers with full pull-out (FP) 100%
- Drawers with 50 mm front height, load capacity 70 kg
Drawers from 75 mm front height, load capacity 100 kg
Load capacity 180 kg on request
- Beech multiplex workbench top, 1250 x 750 x 40 mm
- Levelling feet
- Cylinder lock with two keys
- Working height 859 mm or 959 mm
- 1000 kg total load capacity

Suitable divider material for the R 18-24 can be found on page 75



- Left: 2x shelf
- Right: 3x drawer

Item no.	Dimensions in mm (WxDxH)
03.12.13V	1250 x 750 x 859
03.12.13V9	1250 x 750 x 959



- Left: 1x hinged door, 1x shelf
- Right: 3x drawer

Item no.	Dimensions in mm (WxDxH)
03.12.15V	1250 x 750 x 859
03.12.15V9	1250 x 750 x 959

Individual arrangement

Workbench with 2x empty housing, usable height 600 mm

- Incl. beech multiplex worktop 40 mm

Item no.	Dimensions in mm (WxDxH)
03.12.001	1250 x 750 x 859
03.12.001-9	1250 x 750 x 959



Hinged doors

- Usable width 495 mm

Item no.	Version	Usable heights (mm)
03.050.450L	left	450
03.050.450R	right	450
03.050.600	left+right	600

Shelf

- Load capacity 80 kg

Item no.	Dimensions in mm (WxDxH)
03.1094.01	499 x 705 x 20

Height adjustment of 200 mm

Item no.	Grid
03.15.95	25 mm

- 450 x 600 mm (W x D) with full pull-out 100% - drawers with 50 mm front height: load capacity 70 kg; drawers from 75 mm front height: load capacity 100 kg



Item no.	Front height (mm)	Shell height (mm)	Usable heights (mm)
60.50.050V07	50	28	30
60.50.075V10	75	56	58
60.50.100V10	100	81	83
60.50.125V10	125	81	108
60.50.150V10	150	131	133
60.50.175V10	175	131	158
60.50.200V10	200	181	183
60.50.250V10	250	181	233
60.50.300V10	300	181	283



- Left: 1x hinged door, 1x shelf
- Right: 1x hinged door, 1x shelf

Item no.	Dimensions in mm (WxDxH)
03.12.04V	1250 x 750 x 859
03.12.04V9	1250 x 750 x 959



- Left: 2x drawer, 1x hinged door
- Right: 2x drawer, 1x hinged door

Item no.	Dimensions in mm (WxDxH)
03.12.05V	1250 x 750 x 859
03.12.05V9	1250 x 750 x 959



- Left: 1x drawer, 1x hinged door
- Right: 1x drawer, 1x hinged door

Item no.	Dimensions in mm (WxDxH)
03.12.17V	1250 x 750 x 859
03.12.17V9	1250 x 750 x 959



- Left: 2x drawer, 1x hinged door
- Right: 2x drawer, 1x hinged door

Item no.	Dimensions in mm (WxDxH)
03.12.06V	1250 x 750 x 859
03.12.06V9	1250 x 750 x 959



- Left: 3x drawer
- Right: 5x drawer

Item no.	Dimensions in mm (WxDxH)
03.12.07V	1250 x 750 x 859
03.12.07V9	1250 x 750 x 959



- Left: 4x drawer
- Right: 4x drawer

Item no.	Dimensions in mm (WxDxH)
03.12.08V	1250 x 750 x 859
03.12.08V9	1250 x 750 x 959

Box workbenches

Grid: R 12-14 R 24-12 R 24-16 R 12-16 R 18-16 R 24-16 R 36-16 **R 18-24** R 24-24 R 36-24 R 48-24

Box workbenches 1500 | Depth 750 mm

- Drawer interior dimension 450 x 600 mm
- Drawers with full pull-out (FP) 100%
- Drawers with 50 mm front height, load capacity 70 kg
Drawers from 75 mm front height, load capacity 100 kg
Load capacity 180 kg on request
- Beech multiplex workbench top, 1500 x 750 x 40 mm
- Levelling feet
- Cylinder lock with two keys
- Working height 859 mm or 959 mm
- 1000 kg total load capacity

Suitable divider material for the R 18-24 can be found on page 75



- Left: 1x drawer, 1x hinged door
- Right: 1x drawer, 1x hinged door

Item no.	Dimensions in mm (WxDxH)
03.14.17V	1500 x 750 x 859
03.14.17V9	1500 x 750 x 959



- Left: 1x hinged door, 1x shelf
- Right: 3x drawer

Item no.	Dimensions in mm (WxDxH)
03.14.13V	1500 x 750 x 859
03.14.13V9	1500 x 750 x 959

Individual arrangement

Workbench with 2x empty housing, usable height 600 mm

- Incl. beech multiplex worktop 40 mm

Item no.	Dimensions in mm (WxDxH)
03.14.001	1500 x 750 x 859
03.14.001-9	1500 x 750 x 959



Hinged doors

- Usable width 495 mm

Item no.	Version	Usable heights (mm)
03.050.450L	left	450
03.050.450R	right	450
03.050.600	left+right	600

Shelf

- Load capacity 80 kg

Item no.	Dimensions in mm (WxDxH)
03.1094.01	499 x 705 x 20

Height adjustment of 200 mm

Item no.	Grid
03.15.95	25 mm

- 450 x 600 mm (W x D) with full pull-out 100% - drawers with 50 mm front height: load capacity 70 kg; drawers from 75 mm front height: load capacity 100 kg



Item no.	Front height (mm)	Shell height (mm)	Usable heights (mm)
60.50.050V07	50	28	30
60.50.075V10	75	56	58
60.50.100V10	100	81	83
60.50.125V10	125	81	108
60.50.150V10	150	131	133
60.50.175V10	175	131	158
60.50.200V10	200	181	183
60.50.250V10	250	181	233
60.50.300V10	300	181	283



- Left: 1x hinged door, 1x shelf
- Right: 1x hinged door, 1x shelf

Item no.	Dimensions in mm (WxDxH)
03.14.04V	1500 x 750 x 859
03.14.04V9	1500 x 750 x 959



- Left: 2x drawer, 1x hinged door
- Right: 2x drawer, 1x hinged door

Item no.	Dimensions in mm (WxDxH)
03.14.05V	1500 x 750 x 859
03.14.05V9	1500 x 750 x 959



- Left: 3x drawer
- Right: 3x drawer

Item no.	Dimensions in mm (WxDxH)
03.14.33V	1500 x 750 x 859
03.14.33V9	1500 x 750 x 959



- Left: 2x drawer, 1x hinged door
- Right: 2x drawer, 1x hinged door

Item no.	Dimensions in mm (WxDxH)
03.14.06V	1500 x 750 x 859
03.14.06V9	1500 x 750 x 959



- Left: 3x drawer
- Right: 5x drawer

Item no.	Dimensions in mm (WxDxH)
03.14.07V	1500 x 750 x 859
03.14.07V9	1500 x 750 x 959



- Left: 4x drawer
- Right: 4x drawer

Item no.	Dimensions in mm (WxDxH)
03.14.08V	1500 x 750 x 859
03.14.08V9	1500 x 750 x 959

Box workbenches

Grid: R 12-14 R 24-12 R 24-16 R 12-16 R 18-16 R 24-16 R 36-16 **R 18-24** R 24-24 R 36-24 R 48-24

Box workbenches 1500 | Depth 750 mm

- Drawer interior dimension 450 x 600 mm
- Drawers with full pull-out (FP) 100%
- Drawers with 50 mm front height, load capacity 70 kg
Drawers from 75 mm front height, load capacity 100 kg
Load capacity 180 kg on request
- Beech multiplex workbench top, 1500 x 750 x 40 mm
- Levelling feet
- Cylinder lock with two keys
- Working height 859 mm and 959 mm
- 1000 kg total load capacity

Suitable divider material for the R 18-24 can be found on page 75



- Left: 1x half shelf
- Right: 2x drawer, 1x hinged door

Item no.	Dimensions in mm (WxDxH)
03.14.11V	1500 x 750 x 859
03.14.11V9	1500 x 750 x 959

Individual arrangement

Workbench with empty housing, usable height 600 mm

- Incl. beech multiplex worktop 40mm

Item no.	Version	height in mm
03.14.002	right	859
03.14.002-9	right	959
03.14.002GL	left	859
03.14.002-9GL	left	959

Hinged doors

- Usable width 495 mm

Item no.	Version	Usable heights (mm)
03.050.450L	left	450
03.050.450R	right	450
03.050.600	left+right	600

Shelf

- Load capacity 80 kg

Item no.	Dimensions in mm (WxDxH)
03.1094.01	499 x 705 x 20

Height adjustment of 200 mm

Item no.	Grid
03.15.95	25 mm



- 450 x 600 mm (W x D) with full pull-out 100% - drawers with 50 mm front height: load capacity 70 kg; drawers from 75 mm front height: load capacity 100 kg



Item no.	Front height (mm)	Shell height (mm)	Usable heights (mm)
60.50.050V07	50	28	30
60.50.075V10	75	56	58
60.50.100V10	100	81	83
60.50.125V10	125	81	108
60.50.150V10	150	131	133
60.50.175V10	175	131	158
60.50.200V10	200	181	183
60.50.250V10	250	181	233
60.50.300V10	300	181	283



- Left: 1x half shelf
- Right: 1x hinged door, 1x shelf

Item no.	Dimensions in mm (WxDxH)
03.14.21V	1500 x 750 x 859
03.14.21V9	1500 x 750 x 959



- Left: 1x half shelf
- Right: 1x drawer, 1x hinged door

Item no.	Dimensions in mm (WxDxH)
03.14.22V	1500 x 750 x 859
03.14.22V9	1500 x 750 x 959



- Left: 6x drawer
- Right: 1x half shelf

Item no.	Dimensions in mm (WxDxH)
03.14.23-LV	1500 x 750 x 859
03.14.23-LV9	1500 x 750 x 959



- Left: 5x drawer
- Right: 1x half shelf

Item no.	Dimensions in mm (WxDxH)
03.14.24-LV	1500 x 750 x 859
03.14.24-LV9	1500 x 750 x 959



- Left: 6x drawer
- Right: 1x half shelf

Item no.	Dimensions in mm (WxDxH)
03.14.26-LV	1500 x 750 x 859
03.14.26-LV9	1500 x 750 x 959



- Left: 2x drawer
- Right: 1x half shelf

Item no.	Dimensions in mm (WxDxH)
03.14.27-LV	1500 x 750 x 859
03.14.27-LV9	1500 x 750 x 959

Box workbenches

Grid: R 12-14 R 24-12 R 24-16 R 12-16 R 18-16 R 24-16 R 36-16 R 18-24 **R 24-24** R 36-24 R 48-24

Box workbenches 1500 | Depth 750 mm

- Drawer interior dimension 600 x 600 mm
- Drawers with full pull-out (FP) 100%
- Drawers with 50 mm front height, load capacity 70 kg
Drawers from 75 mm front height, load capacity 100 kg
Load capacity 180 kg on request
- Beech multiplex workbench top, 1500 x 750 x 40 mm
- Levelling feet
- Cylinder lock with two keys
- Working height 859 mm or 959 mm
- 1000 kg total load capacity

Suitable divider material for the R 24-24 can be found on page 83



- Left: 5x drawer
- Right: 1x drawer, 1x hinged door

Item no.	Dimensions in mm (WxDxH)
03.15.07V	1500 x 750 x 859
03.15.07V9	1500 x 750 x 959

Individual arrangement

Workbench with 2x empty housing, usable height 600 mm

- Incl. beech multiplex worktop 40 mm

Item no.	Dimensions in mm (WxDxH)
03.15.001	1500 x 750 x 859
03.15.001-9	1500 x 750 x 959

Hinged doors

- Usable width 645 mm

Item no.	Version	Usable heights (mm)
03.070.450L	left	450
03.070.450R	right	450
03.070.600	left+right	600

Shelf

- Load capacity 80 kg

Item no.	Dimensions in mm (WxDxH)
03.1094.00	649 x 705 x 20

Height adjustment of 200 mm

Item no.	Grid
03.15.95	25 mm

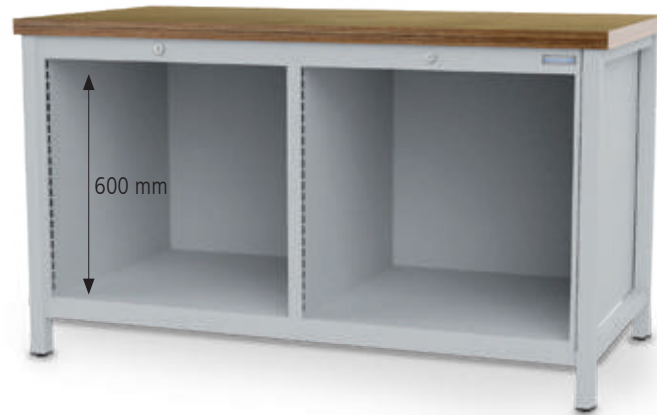

- 600 x 600 mm (W x D) with full pull-out 100% - drawers with 50 mm front height: load capacity 70 kg; drawers from 75 mm front height: load capacity 100 kg



Item no.	Front height (mm)	Shell height (mm)	Usable heights (mm)
60.70.050V07	50	28	30
60.70.075V10	75	56	58
60.70.100V10	100	81	83
60.70.125V10	125	81	108
60.70.150V10	150	131	133
60.70.175V10	175	131	158
60.70.200V10	200	181	183
60.70.250V10	250	181	233
60.70.300V10	300	181	283



- Left: 4x drawer
- Right: 4x drawer

Item no.	Dimensions in mm (WxDxH)
03.15.32V	1500 x 750 x 859
03.15.32V9	1500 x 750 x 959



- Left: 4x drawer
- Right: 1x hinged door, 1x shelf

Item no.	Dimensions in mm (WxDxH)
03.15.41V	1500 x 750 x 859
03.15.41V9	1500 x 750 x 959



- Left: 5x drawer
- Right: 4x drawer

Item no.	Dimensions in mm (WxDxH)
03.15.54V	1500 x 750 x 859
03.15.54V9	1500 x 750 x 959



- Left: 3x drawer
- Right: 1x hinged door, 1x shelf

Item no.	Dimensions in mm (WxDxH)
03.15.31V	1500 x 750 x 859
03.15.31V9	1500 x 750 x 959



- Left: 1x drawer, 1x hinged door
- Right: 1x hinged door, 1x shelf

Item no.	Dimensions in mm (WxDxH)
03.15.21V	1500 x 750 x 859
03.15.21V9	1500 x 750 x 959



- Left: 1x drawer, 1x hinged door
- Right: 2x drawer, 1x hinged door

Item no.	Dimensions in mm (WxDxH)
03.15.23V	1500 x 750 x 859
03.15.23V9	1500 x 750 x 959

Box workbenches

Grid: R 12-14 R 24-12 R 24-16 R 12-16 R 18-16 R 24-16 R 36-16 R 18-24 **R 24-24** R 36-24 R 48-24

Box workbenches 1500 | Depth 750 mm

- Drawer interior dimension 600 x 600 mm
- Drawers with full pull-out (FP) 100%
- Drawers with 50 mm front height, load capacity 70 kg
Drawers from 75 mm front height, load capacity 100 kg
Load capacity 180 kg on request
- Beech multiplex workbench top, 1500 x 750 x 40 mm
- Levelling feet
- Cylinder lock with two keys
- Working height 859 mm or 959 mm
- 1000 kg total load capacity

Suitable divider material for the R 24-24 can be found on page 83



- Left: 2x drawer, 1x hinged door
- Right: 1x half shelf with rear wall

Item no.	Dimensions in mm (WxDxH)
03.15.022V	1500 x 750 x 859
03.15.022V9	1500 x 750 x 959

Individual arrangement

Workbench with 1x empty housing and 1x empty housing with half shelf, with rear wall usable height 600 mm

- Incl. beech multiplex worktop 40 mm

Item no.	Dimensions in mm (WxDxH)
03.15.002	1500 x 750 x 859
03.15.002-9	1500 x 750 x 959

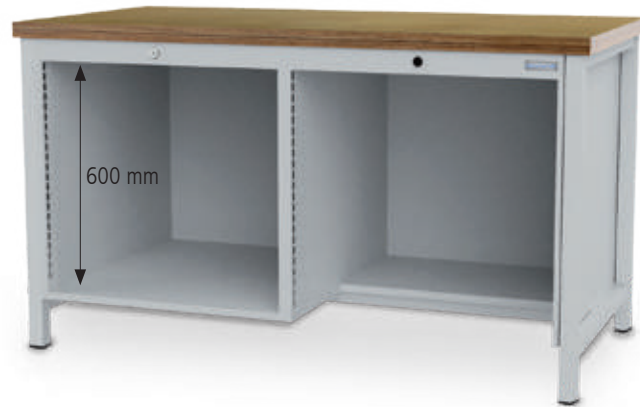

- 600 x 600 mm (W x D) with full pull-out 100% - drawers with 50 mm front height: load capacity 70 kg; drawers from 75 mm front height: load capacity 100 kg



Hinged doors

- Usable width 645 mm

Item no.	Version	Usable heights (mm)
03.070.450L	left	450
03.070.450R	right	450
03.070.600	left+right	600

Shelf

- Load capacity 80 kg

Item no.	Dimensions in mm (WxDxH)
03.1094.00	649 x 705 x 20

Height adjustment of 200 mm

Item no.	Grid
03.15.95	25 mm

Item no.	Front height (mm)	Shell height (mm)	Usable heights (mm)
60.70.050V07	50	28	30
60.70.075V10	75	56	58
60.70.100V10	100	81	83
60.70.125V10	125	81	108
60.70.150V10	150	131	133
60.70.175V10	175	131	158
60.70.200V10	200	181	183
60.70.250V10	250	181	233
60.70.300V10	300	181	283



- Left: 1x hinged door, 1x shelf
- Right: 1x half shelf with rear wall

Item no.	Dimensions in mm (WxDxH)
03.15.026V	1500 x 750 x 859
03.15.026V9	1500 x 750 x 959



- Left: 2x drawer, 1x hinged door
- Right: 1x half shelf with rear wall

Item no.	Dimensions in mm (WxDxH)
03.15.027V	1500 x 750 x 859
03.15.027V9	1500 x 750 x 959



- Left: 1x drawer, 1x hinged door
- Right: 1x half shelf with rear wall

Item no.	Dimensions in mm (WxDxH)
03.15.028V	1500 x 750 x 859
03.15.028V9	1500 x 750 x 959



- Left: 2x drawer
- Right: 1x half shelf with rear wall

Item no.	Dimensions in mm (WxDxH)
03.15.029V	1500 x 750 x 859
03.15.029V9	1500 x 750 x 959



- Left: 1x half shelf with rear wall
- Right: 6x drawer

Item no.	Dimensions in mm (WxDxH)
03.15.030V	1500 x 750 x 859
03.15.030V9	1500 x 750 x 959



- Left: 1x half shelf with rear wall
- Right: 4x drawer

Item no.	Dimensions in mm (WxDxH)
03.15.031V	1500 x 750 x 859
03.15.031V9	1500 x 750 x 959

Box workbenches

Grid: R 12-14 R 24-12 R 24-16 R 12-16 R 18-16 R 24-16 R 36-16 **R 18-24** R 24-24 R 36-24 R 48-24

Box workbenches 2000 | Depth 750 mm

- Drawer interior dimension 450 x 600 mm
- Drawers with full pull-out (FP) 100%
- Drawers with 50 mm front height, load capacity 70 kg
Drawers from 75 mm front height, load capacity 100 kg
Load capacity 180 kg on request
- Beech multiplex workbench top, 2000 x 750 x 40 mm
- Levelling feet
- Cylinder lock with two keys
- Working height 859 mm or 959 mm
- 1000 kg total load capacity

Suitable divider material for the R 18-24 can be found on page 75



Perforated walls see page 307



- Left: 1x half shelf
- Right: 1x drawer, 1x hinged door
- **Supplied without perforated wall**

Item no.	Dimensions in mm (WxDxH)
03.19.12V	2000 x 750 x 859
03.19.12V9	2000 x 750 x 959

Individual arrangement

Workbench with empty housing, usable height 600 mm

- Incl. beech multiplex worktop 40 mm

Item no.	Version	heights in mm
03.19.003	left	859
03.19.003-9	left	959
03.19.003GR	right	859
03.19.003-9GR	right	959



Hinged doors

- Usable width 495 mm

Item no.	Version	Usable heights (mm)
03.050.450L	left	450
03.050.450R	right	450
03.050.600	left+right	600

- 450 x 600 mm (W x D) with full pull-out 100% - drawers with 50 mm front height: load capacity 70 kg; drawers from 75 mm front height: load capacity 100 kg



Item no.	Front height (mm)	Shell height (mm)	Usable heights (mm)
60.50.050V07	50	28	30
60.50.075V10	75	56	58
60.50.100V10	100	81	83
60.50.125V10	125	81	108
60.50.150V10	150	131	133
60.50.175V10	175	131	158
60.50.200V10	200	181	183
60.50.250V10	250	181	233
60.50.300V10	300	181	283

Shelf

- Load capacity 80 kg

Item no.	Dimensions in mm (WxDxH)
03.1094.01	499 x 705 x 20

Height adjustment of 200 mm

Item no.	Grid
03.15.95	25 mm



- Left: 1x half shelf
- Right: 1x hinged door, 1x shelf

Item no.	Dimensions in mm (WxDxH)
03.19.13V	2000 x 750 x 859
03.19.13V9	2000 x 750 x 959



- Left: 1x half shelf
- Right: 1x drawer, 1x hinged door

Item no.	Dimensions in mm (WxDxH)
03.19.17V	2000 x 750 x 859
03.19.17V9	2000 x 750 x 959



- Left: 6x drawer
- Right: 1x half shelf

Item no.	Dimensions in mm (WxDxH)
03.19.18V	2000 x 750 x 859
03.19.18V9	2000 x 750 x 959

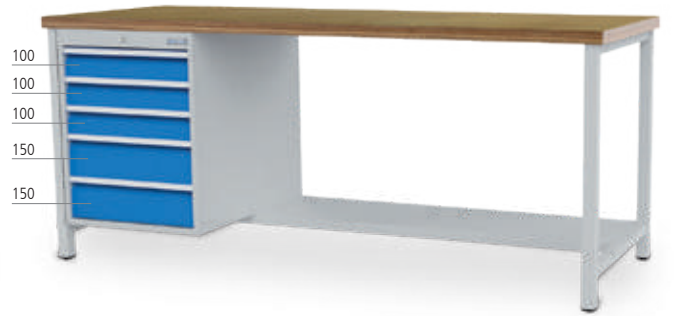

- Left: 5x drawer
- Right: 1x half shelf

Item no.	Dimensions in mm (WxDxH)
03.19.19V	2000 x 750 x 859
03.19.19V9	2000 x 750 x 959

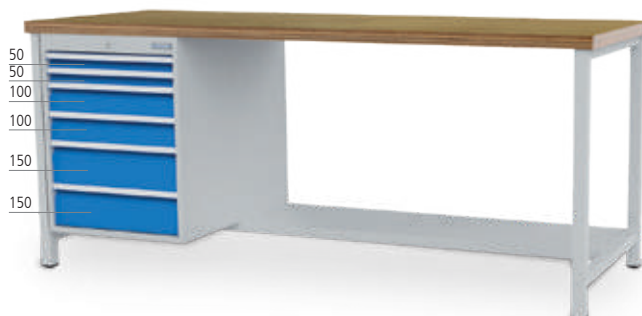

- Left: 6x drawer
- Right: 1x half shelf

Item no.	Dimensions in mm (WxDxH)
03.19.11V	2000 x 750 x 859
03.19.11V9	2000 x 750 x 959



- Left: 2x drawer
- Right: 1x half shelf

Item no.	Dimensions in mm (WxDxH)
03.19.10V	2000 x 750 x 859
03.19.10V9	2000 x 750 x 959

Box workbenches

Grid: R 12-14 R 24-12 R 24-16 R 12-16 R 18-16 R 24-16 R 36-16 **R 18-24** R 24-24 R 36-24 R 48-24

Box workbenches 2000 | Depth 750 mm

- Drawer interior dimension 450 x 600 mm
- Drawers with full pull-out (FP) 100%
- Drawers with 50 mm front height, load capacity 70 kg
Drawers from 75 mm front height, load capacity 100 kg
Load capacity 180 kg on request
- Beech multiplex workbench top, 2000 x 750 x 40 mm
- Levelling feet
- Cylinder lock with two keys
- Working height 859 mm or 959 mm
- 1000 kg total load capacity

Suitable divider material for the R 18-24 can be found on page 75



- Left: 1x drawer, 1x hinged door
- Central: 1x half shelf with rear wall
- Right: 3x drawer

Item no.	Dimensions in mm (WxDxH)
03.19.24V	2000 x 750 x 859
03.19.24V9	2000 x 750 x 959

Individual arrangement

Workbench with 2x empty housing and 1x half shelf with rear wall, usable height 600 mm

- Incl. beech multiplex worktop 40 mm

Item no.	Dimensions in mm (WxDxH)
03.19.002	2000 x 750 x 859
03.19.002-9	2000 x 750 x 959



- 450 x 600 mm (W x D) with full pull-out 100% - drawers with 50 mm front height: load capacity 70 kg; drawers from 75 mm front height: load capacity 100 kg

Hinged doors

- Usable width 495 mm

Item no.	Version	Usable heights (mm)
03.050.450L	left	450
03.050.450R	right	450
03.050.600	left+right	600

Shelf

- Load capacity 80 kg

Item no.	Dimensions in mm (WxDxH)
03.1094.01	499 x 705 x 20

Height adjustment of 200 mm

Item no.	Grid
03.15.95	25 mm

Item no.	Front height (mm)	Shell height (mm)	Usable heights (mm)
60.50.050V07	50	28	30
60.50.075V10	75	56	58
60.50.100V10	100	81	83
60.50.125V10	125	81	108
60.50.150V10	150	131	133
60.50.175V10	175	131	158
60.50.200V10	200	181	183
60.50.250V10	250	181	233
60.50.300V10	300	181	283



- Left: 4x drawer
- Central: 1x half shelf with rear wall
- Right: 5x drawer

Item no.	Dimensions in mm (WxDxH)
03.19.45V	2000 x 750 x 859
03.19.45V9	2000 x 750 x 959



- Left: 3x drawer
- Central: 1x half shelf with rear wall
- Right: 3x drawer

Item no.	Dimensions in mm (WxDxH)
03.19.25V	2000 x 750 x 859
03.19.25V9	2000 x 750 x 959



- Left: 4x drawer
- Central: 1x half shelf with rear wall
- Right: 1x drawer, 1x hinged door

Item no.	Dimensions in mm (WxDxH)
03.19.42V	2000 x 750 x 859
03.19.42V9	2000 x 750 x 959



- Left: 1x hinged door, 1x shelf
- Central: 1x half shelf with rear wall
- Right: 1x hinged door, 1x shelf

Item no.	Dimensions in mm (WxDxH)
03.19.27V	2000 x 750 x 859
03.19.27V9	2000 x 750 x 959



- Left: 4x drawer
- Central: 1x half shelf with rear wall
- Right: 4x drawer

Item no.	Dimensions in mm (WxDxH)
03.19.28V	2000 x 750 x 859
03.19.28V9	2000 x 750 x 959



- Left: 3x drawer
- Central: 1x half shelf with rear wall
- Right: 4x drawer

Item no.	Dimensions in mm (WxDxH)
03.19.29V	2000 x 750 x 859
03.19.29V9	2000 x 750 x 959

Box workbenches

Grid: R 12-14 R 24-12 R 24-16 R 12-16 R 18-16 R 24-16 R 36-16 **R 18-24** R 24-24 R 36-24 R 48-24

Box workbenches 2000 | Depth 750 mm

- Drawers with full pull-out (FP) 100%
- Drawers with 50 mm front height, load capacity 70 kg
Drawers from 75 mm front height, load capacity 100 kg
Load capacity 180 kg on request
- Beech multiplex workbench top, 2000 x 750 x 40 mm
- Levelling feet
- Cylinder lock with two keys
- Working height 859 mm or 959 mm
- 1000 kg total load capacity

Suitable divider material for the R 18-24 can be found on page 75



- Left: 1x drawer, 1x hinged door
- Central: 1x drawer, 1x hinged door
- Right: 1x drawer, 1x hinged door

Item no.	Dimensions in mm (WxDxH)
03.19.32V	2000 x 750 x 859
03.19.32V9	2000 x 750 x 959

Individual arrangement

Workbench with 3x empty housing, usable height 600 mm

- Incl. beech multiplex worktop 40 mm

Item no.	Dimensions in mm (WxDxH)
03.19.001	2000 x 750 x 859
03.19.001-9	2000 x 750 x 959

Hinged doors

- Usable width 495 mm

Item no.	Version	Usable heights (mm)
03.050.450L	left	450
03.050.450R	right	450
03.050.600	left+right	600

Shelf

- Load capacity 80 kg

Item no.	Dimensions in mm (WxDxH)
03.1094.01	499 x 705 x 20

Height adjustment of 200 mm

Item no.	Grid
03.15.95	25 mm



- 450 x 600 mm (W x D) with full pull-out 100% - drawers with 50 mm front height: load capacity 70 kg; drawers from 75 mm front height: load capacity 100 kg



Item no.	Front height (mm)	Shell height (mm)	Usable heights (mm)
60.50.050V07	50	28	30
60.50.075V10	75	56	58
60.50.100V10	100	81	83
60.50.125V10	125	81	108
60.50.150V10	150	131	133
60.50.175V10	175	131	158
60.50.200V10	200	181	183
60.50.250V10	250	181	233
60.50.300V10	300	181	283



- Left: 3x drawer
- Central: 3x drawer
- Right: 3x drawer

Item no.	Dimensions in mm (WxDxH)
03.19.33V	2000 x 750 x 859
03.19.33V9	2000 x 750 x 959



- Left: 1x hinged door, 1x shelf
- Central: 3x drawer
- Right: 1x hinged door, 1x shelf

Item no.	Dimensions in mm (WxDxH)
03.19.35V	2000 x 750 x 859
03.19.35V9	2000 x 750 x 959



- Left: 1x drawer, 1x hinged door
- Central: 1x hinged door, 1x shelf
- Right: 1x drawer, 1x hinged door

Item no.	Dimensions in mm (WxDxH)
03.19.34V	2000 x 750 x 859
03.19.34V9	2000 x 750 x 959



- Left: 5x drawer
- Central: 3x drawer
- Right: 1x hinged door, 1x shelf

Item no.	Dimensions in mm (WxDxH)
03.19.36V	2000 x 750 x 859
03.19.36V9	2000 x 750 x 959



- Left: 5x drawer
- Central: 3x drawer
- Right: 4x drawer

Item no.	Dimensions in mm (WxDxH)
03.19.44V	2000 x 750 x 859
03.19.44V9	2000 x 750 x 959



- Left: 4x drawer
- Central: 4x drawer
- Right: 1x hinged door, 1x shelf

Item no.	Dimensions in mm (WxDxH)
03.19.46V	2000 x 750 x 859
03.19.46V9	2000 x 750 x 959

Box workbenches

Grid: R 12-14 R 24-12 R 24-16 R 12-16 R 18-16 R 24-16 R 36-16 R 18-24 **R 24-24** R 36-24 R 48-24

Box workbenches 2000 | Depth 750 mm

- Drawer interior dimension 600 x 600 mm
- Drawers with full pull-out (FP) 100%
- Drawers with 50 mm front height, load capacity 70 kg
Drawers from 75 mm front height, load capacity 100 kg
Load capacity 180 kg on request
- Beech multiplex workbench top, 2000 x 750 x 40 mm
- Levelling feet
- Cylinder lock with two keys
- Working height 859 mm or 959 mm
- 1000 kg total load capacity

Suitable divider material for the R 24-24 can be found on page 83



- Left: 4x drawer
- Central: 2x shelf with rear wall
- Right: 2x drawer, 1x hinged door

Item no.	Dimensions in mm (WxDxH)
03.20.03V	2000 x 750 x 859
03.20.03V9	2000 x 750 x 959

Individual arrangement

Workbench with 2x empty housing, usable height 600 mm 2 shelves in the centre with rear wall

- Incl. beech multiplex worktop 40 mm

Item no.	Dimensions in mm (WxDxH)
03.20.001	2000 x 750 x 859
03.20.001-9	2000 x 750 x 959

Hinged doors

- Usable width 645 mm

Item no.	Version	Usable heights (mm)
03.070.450L	left	450
03.070.450R	right	450
03.070.600	left+right	600

Shelf

- Load capacity 80 kg

Item no.	Dimensions in mm (WxDxH)
03.1094.00**	649 x 705 x 20
03.1094.03*	536 x 705 x 20

* Centre shelf

** Shelf behind hinged door

Height adjustment of 200 mm

Item no.	Grid
03.15.95	25 mm



- 600 x 600 mm (W x D) with full pull-out 100% - drawers with 50 mm front height: load capacity 70 kg; drawers from 75 mm front height: load capacity 100 kg



Item no.	Front height (mm)	Shell height (mm)	Usable heights (mm)
60.70.050V07	50	28	30
60.70.075V10	75	56	58
60.70.100V10	100	81	83
60.70.125V10	125	81	108
60.70.150V10	150	131	133
60.70.175V10	175	131	158
60.70.200V10	200	181	183
60.70.250V10	250	181	233
60.70.300V10	300	181	283



- Left: 4x drawer
- Central: 2x shelf with rear wall
- Right: 4x drawer

Item no.	Dimensions in mm (WxDxH)
03.20.04V	2000 x 750 x 859
03.20.04V9	2000 x 750 x 959



- Left: 5x drawer
- Central: 2x shelf with rear wall
- Right: 4x drawer

Item no.	Dimensions in mm (WxDxH)
03.20.11V	2000 x 750 x 859
03.20.11V9	2000 x 750 x 959



- Left: 1x drawer, 1x hinged door
- Central: 2x shelf with rear wall
- Right: 3x drawer

Item no.	Dimensions in mm (WxDxH)
03.20.14V	2000 x 750 x 859
03.20.14V9	2000 x 750 x 959



- Left: 3x drawer
- Central: 2x shelf with rear wall
- Right: 3x drawer

Item no.	Dimensions in mm (WxDxH)
03.20.18V	2000 x 750 x 859
03.20.18V9	2000 x 750 x 959



- Left: 5x drawer
- Central: 2x shelf with rear wall
- Right: 5x drawer

Item no.	Dimensions in mm (WxDxH)
03.20.15V	2000 x 750 x 859
03.20.15V9	2000 x 750 x 959



- Left: 2x drawer, 1x hinged door
- Central: 2x shelf with rear wall
- Right: 4x drawer

Item no.	Dimensions in mm (WxDxH)
03.20.13V	2000 x 750 x 859
03.20.13V9	2000 x 750 x 959

Box workbenches

Grid: R 12-14 R 24-12 R 24-16 R 12-16 R 18-16 R 24-16 R 36-16 **R 18-24** R 24-24 R 36-24 R 48-24

Box workbenches 2500 | Depth 750 mm

- Drawer interior dimension 450 x 600 mm
- Drawers with full pull-out (FP) 100%
- Drawers with 50 mm front height, load capacity 70 kg
Drawers from 75 mm front height, load capacity 100 kg
Load capacity 180 kg on request
- Beech multiplex workbench top, 2500 x 750 x 40 mm
- Levelling feet
- Cylinder lock with two keys
- Working height 859 mm or 959 mm
- 1000 kg total load capacity
- Delivered partially assembled, worktop delivered separately

Suitable divider material for the R 18-24 can be found on page 75



- Far left: 1x drawer, 1x hinged door
- Centre left: 1x drawer, 1x hinged door
- Centre right: 1x drawer, 1x hinged door
- Far right: 1x drawer, 1x hinged door

Item no.	Dimensions in mm (WxDxH)
03.25.2222V	2500 x 750 x 859
03.25.2222V9	2500 x 750 x 959

Individual arrangement

Workbench with 4x empty housing, usable height 600 mm

- Incl. beech multiplex worktop 40 mm

Item no.	Dimensions in mm (WxDxH)
03.25.001	2500 x 750 x 859
03.25.001-9	2500 x 750 x 959



Hinged doors

- Usable width 495 mm

Item no.	Version	Usable heights (mm)
03.050.450L	left	450
03.050.450R	right	450
03.050.600	left+right	600

Shelf

- Load capacity 80 kg

Item no.	Dimensions in mm (WxDxH)
03.1094.01	499 x 705 x 20

Height adjustment of 200 mm

Item no.	Grid
03.15.95	25 mm

- 450 x 600 mm (W x D) with full pull-out 100% - drawers with 50 mm front height: load capacity 70 kg; drawers from 75 mm front height: load capacity 100 kg



Item no.	Front height (mm)	Shell height (mm)	Usable heights (mm)
60.50.050V07	50	28	30
60.50.075V10	75	56	58
60.50.100V10	100	81	83
60.50.125V10	125	81	108
60.50.150V10	150	131	133
60.50.175V10	175	131	158
60.50.200V10	200	181	183
60.50.250V10	250	181	233
60.50.300V10	300	181	283



- Far left: 3x drawer
- Centre left: 1x hinged door, 1x shelf
- Centre right: 3x drawer
- Far right: 1x hinged door, 1x shelf

Item no.	Dimensions in mm (WxDxH)
03.25.3131V	2500 x 750 x 859
03.25.3131V9	2500 x 750 x 959



- Far left: 1x drawer, 1x hinged door
- Centre left: 3x drawer
- Centre right: 4x drawer
- Far right: 1x drawer, 1x hinged door

Item no.	Dimensions in mm (WxDxH)
03.25.2342V	2500 x 750 x 859
03.25.2342V9	2500 x 750 x 959



- Far left: 4x drawer
- Centre left: 4x drawer
- Centre right: 3x drawer
- Far right: 3x drawer

Item no.	Dimensions in mm (WxDxH)
03.25.4433V	2500 x 750 x 859
03.25.4433V9	2500 x 750 x 959



- Far left: 1x hinged door, 1x shelf
- Centre left: 5x drawer
- Centre right: 3x drawer
- Far right: 2x drawer

Item no.	Dimensions in mm (WxDxH)
03.25.1532V	2500 x 750 x 859
03.25.1532V9	2500 x 750 x 959



- Far left: 5x drawer
- Centre left: 5x drawer
- Centre right: 4x drawer
- Far right: 1x hinged door, 1x shelf

Item no.	Dimensions in mm (WxDxH)
03.25.5541V	2500 x 750 x 859
03.25.5541V9	2500 x 750 x 959



- Far left: 6x drawer
- Centre left: 4x drawer
- Centre right: 3x drawer
- Far right: 2x drawer

Item no.	Dimensions in mm (WxDxH)
03.25.6432V	2500 x 750 x 859
03.25.6432V9	2500 x 750 x 959

Workbenches

Worktables/workbenches

- Stable square tube frame 40 x 40 x 2 mm
- For assembly, workshop and shipping
- Rear stiffening plate connected to worktop and frame
- Half shelf depth 385 mm
- Beech multiplex worktop, 1500/2000 x 750 x 40 mm
- Levelling feet
- Working height 859 mm or 959 mm
- Load Capacity 300 kg
- Delivered fully assembled



Worktable/bench

- Beech multiplex worktop 40 mm
- 1x half shelf

Item no.	Dimensions in mm (WxDxH)
03.14.30	1500 x 750 x 859
03.14.30-9	1500 x 750 x 959
03.19.30	2000 x 750 x 859
03.19.30-9	2000 x 750 x 959

Suitable divider material for the R 18-24 can be found on page 75



Worktable/bench R 18-24

- Beech multiplex worktop 40 mm
- 1x half shelf
- 1x drawer 150 mm, full pull-out, load capacity 100 kg
- Cylinder lock with two keys

Item no.	Dimensions in mm (WxDxH)
03.14.31V	1500 x 750 x 859
03.14.31V-9	1500 x 750 x 959
03.19.31V	2000 x 750 x 859
03.19.31V-9	2000 x 750 x 959



Worktable/bench R 18-24

- Beech multiplex worktop 40 mm
- 1x half shelf
- Left: 1x drawer 150 mm, full pull-out, load capacity 100 kg
- Right: 1x drawer 150 mm, full pull-out, load capacity 100 kg
- Cylinder lock with two keys

Item no.	Dimensions in mm (WxDxH)
03.14.32V	1500 x 750 x 859
03.14.32V-9	1500 x 750 x 959
03.19.32.1V	2000 x 750 x 859
03.19.32.1V-9	2000 x 750 x 959

New dimensions

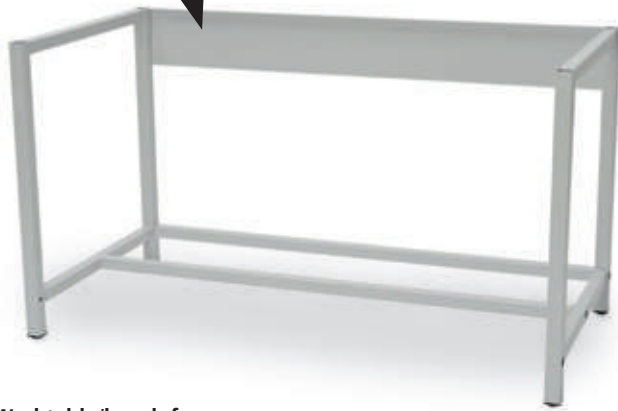

Worktable/bench frame

- Stable square tube frame 40 x 40 x 2 mm
- For assembly, workshop and shipping
- Levelling feet
- Supplied without worktop and steel shelf



Item no.	Dimensions in mm (WxDxH)
03.055.00	625 x 736 x 819
03.055.00-9	625 x 736 x 919
03.075.00	775 x 736 x 819
03.075.00-9	775 x 736 x 919
03.10.00	965 x 736 x 819
03.10.00-9	965 x 736 x 919
03.12.00	1165 x 736 x 819
03.12.00-9	1165 x 736 x 919
03.14.00	1465 x 736 x 819
03.14.00-9	1465 x 736 x 919
03.17.00	1708 x 736 x 819
03.17.00-9	1708 x 736 x 919
03.19.00	1965 x 736 x 819
03.19.00-9	1965 x 736 x 919

More Worktops from page 422



Beech multiplex worktop

- Glue laminated, oiled
- Water repellent
- Gluing according to EN 314-2

Item no.	Dimensions in mm (WxDxH)
03.7575.40	750 x 750
03.81.40	810 x 750
03.10.40	1000 x 750
03.125.40	1250 x 750
03.15.40	1500 x 750
03.1775.40	1750 x 750
03.20.40	2000 x 750
03.25.40	2500 x 750



The worktables and workbenches are generally equipped with levelling feet.



Steel shelf, full depth

- Includes an additional brace underneath
- Load capacity 80 kg

Item no.	Dimensions in mm (WxDxH)	Table width in mm
03.2018-06D	542 x 735 x 40	625
03.2018-08D	693 x 735 x 40	775
03.2018-01D	883 x 735 x 40	965
03.2018-07D	1083 x 735 x 40	1165
03.2018-02D	1383 x 735 x 40	1465
03.2018-09D	1623 x 735 x 40	1708
03.2018-05D	1883 x 735 x 40	1965

Steel shelf, half depth

- Load capacity 80 kg

Item no.	Dimensions in mm (WxDxH)	Table width in mm
03.2018-06	543 x 385 x 40	625
03.2018-08	693 x 385 x 40	775
03.2018-01	883 x 385 x 40	965
03.2018-07	1083 x 385 x 40	1165
03.2018-02	1383 x 385 x 40	1465
03.2018-09	1623 x 385 x 40	1708
03.2018-05	1883 x 385 x 40	1965

Workbenches

Worktables/workbenches

New



Additional front brace

Item no.	Dimensions in mm (WxDxH)	Table width in mm
03.02-00113	545 x 35 x 35	625
03.02-00110	695 x 35 x 35	775
03.02-00793	885 x 35 x 35	965
03.02-00218	1085 x 35 x 35	1165
03.02-00109	1385 x 35 x 35	1465
03.02-00212	1628 x 35 x 35	1708
03.02-00108	1885 x 35 x 35	1965

With an additional front brace, a pair of adapters is needed for mounting a hanging base cabinet

- Beech multiplex

Item no.	Dimensions in mm (WxDxH)
03ADAPAWTSL	650 x 35 x 35

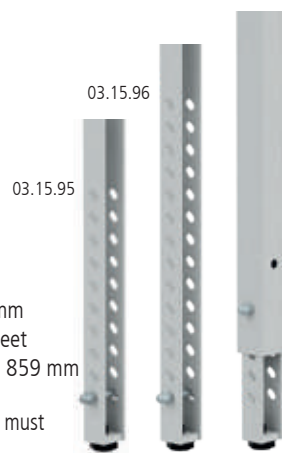

Height adjustment

- Height-adjustable on a grid of 25 mm
- Complete for a workbench with 4 feet
- Only suitable for workbench height 859 mm
- When retrofitting already delivered workbenches, the holes for mounting must be drilled yourself

Item no.	Version
03.15.95	Height adjustment of 200 mm
03.15.96	Height adjustment of 300 mm

New



Floor anchor

- For floor anchoring workbenches
- 4 anchors

Item no.
03.00.34



Mobile add-on (not retrofittable)

- 4x steering caster, Ø 125 mm, thereof 2 with locks
- Load capacity 400 kg
- Working height 950 or 1050 mm
- With handle

Item no.
04.KWBM125

Mobile add-on (not retrofittable)

- Only for box workbenches with 859 mm height
- 2x fixed caster, 2x steering caster with lock, Ø 200 mm
- Load capacity 600 kg
- Working height 990 mm
- With handle

Item no.
04.KWBM200

Mobile workbenches
s. page 486



Example application



New



Lift/lower chassis retrofittable

- Dynamic load capacity: 450 kg
- Static load capacity: 1000 kg
- 2x steering caster, 2x fixed caster, Ø 80 mm, polyamide
- **Not possible for workbenches with half shelf**
- Only suitable for workbench height 859 mm

Item no.	Width in mm	Weight in kg
03.HUB08175	810	20,5
03.HUB12075	1250	24,4
03.HUB15075	1500	27,4
03.HUB17575	1750	29,9
03.HUB20075	2000	32,4

Lift/lower chassis retrofittable

- Dynamic load capacity: 450 kg
- Static load capacity: 1000 kg
- 2x steering caster, 2x fixed caster, Ø 80 mm, polyamide
- **Not possible for workbenches with half shelf**
- Only suitable for workbench height 959 mm

Item no.	Width in mm	Weight in kg
03.HUB081759	810	24,0
03.HUB120759	1250	27,8
03.HUB150759	1500	30,8
03.HUB175759	1750	33,3
03.HUB200759	2000	35,8

Inline workbenches



- Housing made from high-quality thin sheet metal
- Welded base frame made of 50 x 50 x 2 mm square tube
- Maximum load of up to 1 t
- The modular principle enables a variable arrangement of the mobile drawer cabinets or workbench feet
- Usable height of housing 700 mm, doors and drawers flush with the housing
- Recessed, full-length handle bars with labelling strips and transparent cover
- Secure central locking, combination locking systems are possible
- Drawers with ball-bearing guides
- Worktops made of beech multiplex, glue laminated, oiled, water-repellent
- Delivered unassembled, for easy self-assembly

Depth 600 mm

Quick info		
Worktop	Beech multiplex	40 mm or 25 mm
Drawers	Height	819 mm
	Pull-out	100 %
	Single pull-out lock	Yes
	Load capacity	50 – 75 kg
	Ball bearing guides	Yes
Grid	R 24-16 and R 36-16	
Lock	Cylinder lock with two keys	Yes
	Master key	Yes
General dimensions		
Work height	859 mm	
Worktop depth	600 mm	
Drawer heights	75, 100, 150, 200, 250, 300 mm	
Internal drawer height	Front height minus 10 mm	
Drawers (W x D)	600 x 400 mm and 900 x 400 mm	
Choose from our extensive range of colours. Combinations are possible without extra charge. When placing your order, please indicate the desired colour/colour combination. Our standard colours can be found on page 27		

Depth 750 mm

Quick info		
Worktop	Beech multiplex	40 mm
Drawers	Height	819 mm
	Full pull-out	100 %
	Single pull-out lock	Yes
	Load capacity	70 – 100 kg
	Ball-bearing guides	Yes
Grid	R 18-24 and R 24-24	
Lock	Cylinder lock with two keys	Yes
	Master key	Yes
General dimensions		
Work height	859 mm	
Worktop depth	750 mm	
Drawer heights	50, 75, 100, 125, 150, 175, 200, 250, 300, 400 mm	
Internal drawer height	Front height minus 17 mm	
Drawers (W x D)	450 x 600 mm and 600 x 600 mm	
Choose from our extensive range of colours. Combinations are possible without extra charge. When placing your order, please indicate the desired colour/colour combination. 1 st colour = body colour, 2 nd colour = front colour Our standard colours can be found on page 27		

Inline workbenches 1500 | 600 mm

R 24-16 drawer series

- Drawer interior dimension 600 x 400 mm
- Load capacity of drawers either 50 kg or 75 kg
- Base frame, fixed height made of 50 x 50 x 2 mm square tube
- HA-foot 719 – 1019 mm, made of 70 x 40 x 2 mm U-profile
- Beech multiplex workbench top, 1500 x 600 mm
- Cylinder lock with two keys
- 1000 kg total load capacity
- Delivered unassembled, for easy self-assembly

Suitable divider material for the R 24-16 can be found on page 57



- Beech multiplex worktop, 1500 x 600 x 25 mm
- 4x drawer

Item no.	Dimensions in mm (WxDxH)	Load capacity
03.068.103	1500 x 600 x 844	50 kg
03.068.103-75	1500 x 600 x 844	75 kg



- Beech multiplex worktop, 1500 x 600 x 40 mm
- 5x drawer

Item no.	Dimensions in mm (WxDxH)	Load capacity
03.068.221	1500 x 600 x 859	50 kg
03.068.221-75	1500 x 600 x 859	75 kg



Beech multiplex worktop

Item no.	Dimensions in mm (WxDxH)
03.1560.25	1500 x 600 x 25
03.1560.40	1500 x 600 x 40

03.50.01
Base frame, fixed height

Base frame

Item no.	Dimensions in mm (WxDxH)
03.50.01	150 x 500 x 819
03.50.02	150 x 500 x 719 – 1019



Drawer cabinets R 24-16

680 x 500 x 819 mm



- 4x drawer

Item no.	Load capacity
68.022	50 kg
68.022-75	75 kg

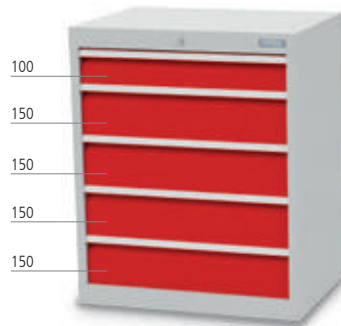

- 5x drawer

Item no.	Load capacity
68.140	50 kg
68.140-75	75 kg



- 6x drawer

Item no.	Load capacity
68.420	50 kg
68.420-75	75 kg

Other base cabinets can be found on/from page 259

Inline workbenches 2000 | 600 mm

R 36-16 drawer series

- Drawer interior dimension 900 x 400 mm
- Base frame, fixed height made of 50 x 50 x 2 mm square tube
- HA-foot 719 – 1019 mm, made of 70 x 40 x 2 mm U-profile
- Beech multiplex workbench top, 2000 x 600 mm
- Cylinder lock with two keys
- 1000 kg total load capacity
- Delivered unassembled, for easy self-assembly

Suitable divider material for the R 36-16 can be found on page 63



- Beech multiplex worktop, 2000 x 600 x 25 mm
- 4x drawer

Item no.	Dimensions in mm (WxDxH)	Load capacity
03.098.103	2000 x 600 x 844	50 kg
03.098.103-75	2000 x 600 x 844	75 kg

- Beech multiplex worktop, 2000 x 600 x 40 mm
- 5x drawer

Item no.	Dimensions in mm (WxDxH)	Load capacity
03.098.221	2000 x 600 x 859	50 kg
03.098.221-75	2000 x 600 x 859	75 kg



Beech multiplex worktop

Item no.	Dimensions in mm (WxDxH)
03.2060.25	2000 x 600 x 25
03.2060.40	2000 x 600 x 40

Base frame

Item no.	Dimensions in mm (WxDxH)
03.50.01	150 x 500 x 819
03.50.02	150 x 500 x 719 – 1019

03.50.02
Base frame, height-adjustable



Drawer cabinets R 36-16

980 x 500 x 819 mm



- 5x drawer

Item no.	Load capacity
98.140	50 kg
98.140-75	75 kg



- 6x drawer

Item no.	Load capacity
98.420	50 kg
98.420-75	75 kg



- 7x drawer

Item no.	Load capacity
98.700	50 kg
98.700-75	75 kg

Inline workbenches 1500/2000 | Depth 750 mm

Drawer cabinets R 18-24

- Drawer interior dimension 450 x 600 mm
- Drawers with full pull-out (FP) 100%
- Drawers with 50 mm front height, load capacity 70 kg
Drawers from 75 mm front height, load capacity 100 kg
Load capacity 180 kg on request
- Beech multiplex workbench top, 1500/2000 x 750 x 40 mm
- Base frame, fixed height made of 50 x 50 x 2 mm square tube
- HA-foot 719 – 1019 mm, made of 70 x 40 x 2 mm U-profile
- Cylinder lock with two keys
- 200 kg total load capacity
- Delivered unassembled, for easy self-assembly



- With shelf

Item no.	Dimensions in mm (WxDxH)
03.15.000.2	1500 x 750 x 859
03.20.000.2	2000 x 750 x 859



- Feet height-adjustable by 200 mm

Item no.	Dimensions in mm (WxDxH)
03.15.000.3	1500 x 750 x 759 – 1059
03.20.000.3	2000 x 750 x 759 – 1059

Individual arrangement

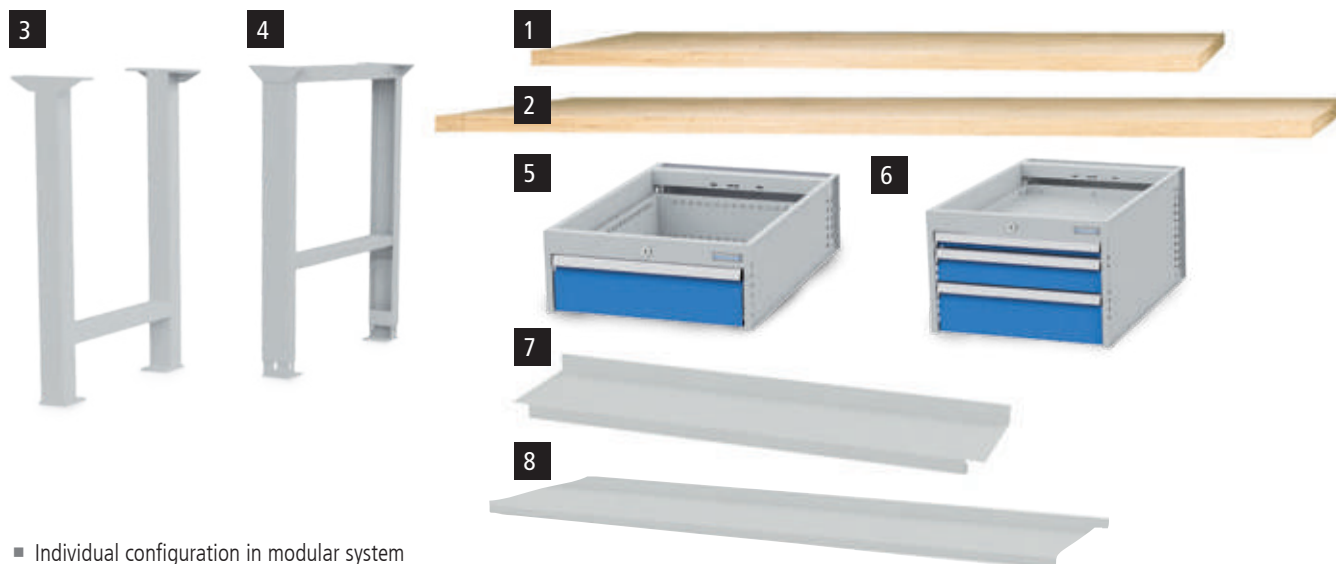

- Individual configuration in modular system

Item no.	Designation	Description	Dimensions in mm (WxDxH)
1 03.15.40	Beech multiplex worktop	Glue laminated, oiled	1500 x 750 x 40 mm
2 03.20.40			2000 x 750 x 40 mm
3 03.90.01	Base frame	Made of 50 x 50 x 2 mm square tube	150 x 650 x 819 mm
4 03.90.01HV	Base frame, height adjustable	Made of 70 x 40 x 2 mm square tube	150 x 650 x 719 – 1019 mm
5 520/1V	Hanging base cabinet R 18-24	1x drawer, 150 mm	541 x 736 x 208 mm
6 535/111V		1x drawer 50 mm, 1x 100 mm, 1x 150 mm	541 x 736 x 358 mm
7 03.2018-10	Steel shelf	For table width 1500 mm	1295 x 300 x 40 mm
8 03.2018-11	Steel shelf	For table width 2000 mm	1795 x 300 x 40 mm



■ Hanging base cabinet: 1x drawer

Item no.	Dimensions in mm (WxDxH)	Base frame
03.15.520.1V	1500 x 750 x 859	fixed height
03.20.520.1V	2000 x 750 x 859	fixed height
03.15.520.1HVV	1500 x 750 x 759 – 1059	height-adjustable
03.20.520.1HVV	2000 x 750 x 759 – 1059	height-adjustable

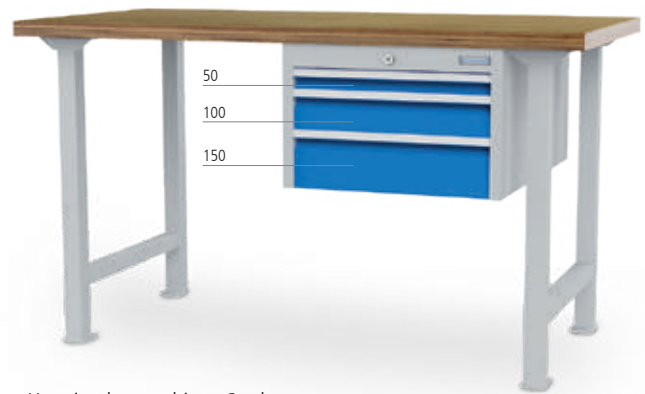

■ Hanging base cabinet: 3x drawer

Item no.	Dimensions in mm (WxDxH)	Base frame
03.15.535.2V	1500 x 750 x 859	fixed height
03.20.535.2V	2000 x 750 x 859	fixed height
03.15.535.2HVV	1500 x 750 x 759 – 1059	height-adjustable
03.20.535.2HVV	2000 x 750 x 759 – 1059	height-adjustable



■ 2x hanging base cabinet:
Left: 1x drawer Right: 1x drawer

Item no.	Dimensions in mm (WxDxH)	Base frame
03.15.520.2V	1500 x 750 x 859	fixed height
03.20.520.2V	2000 x 750 x 859	fixed height
03.15.520HVV	1500 x 750 x 759 – 1059	height-adjustable
03.20.520HVV	2000 x 750 x 759 – 1059	height-adjustable

You can find further hanging base cabinets on page 259



Inline workbenches 1500/2000 | Depth 750 mm

Drawer cabinets R 18-24

- Drawer interior dimension 450 x 600 mm
- 1x drawer cabinet
- Drawers with full pull-out (FP) 100%
- Drawers with 50 mm front height, load capacity 70 kg
- Drawers from 75 mm front height, load capacity 100 kg
- Load capacity 180 kg on request

- Base frame made of 50 x 50 x 2 mm square tube
- Beech multiplex workbench top, 1500/2000 x 750 x 40 mm
- Cylinder lock with two keys
- 1000 kg total load capacity
- Delivered unassembled, for easy self-assembly

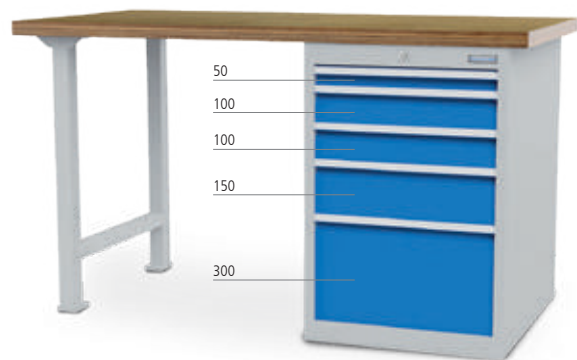
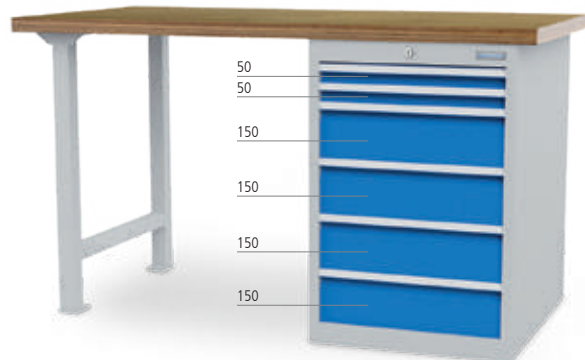

- Drawer cabinet: 6x drawer

- Drawer cabinet: 5x drawer

Item no.	Dimensions in mm (WxDxH)
03.15.580.7V	1500 x 750 x 859
03.20.580.7V	2000 x 750 x 859

Item no.	Dimensions in mm (WxDxH)
03.15.580.5V	1500 x 750 x 859
03.20.580.5V	2000 x 750 x 859

Individual arrangement

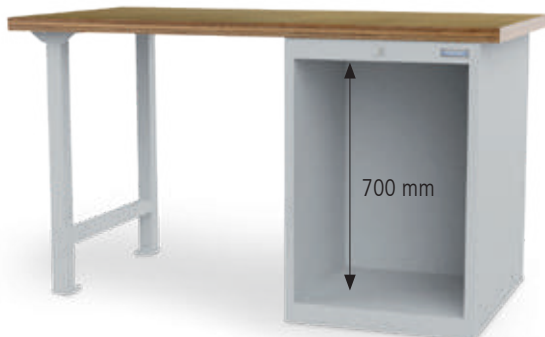

Workbench with 1x empty housing, usable height 700 mm

- Incl. beech multiplex worktop 40 mm

Workbench with 1x empty housing, usable height 700 mm

- Incl. beech multiplex worktop 40 mm

Item no.	Dimensions in mm (WxDxH)
03.15.580.001	1500 x 750 x 859

Item no.	Dimensions in mm (WxDxH)
03.20.580.001	2000 x 750 x 859

Hinged doors

- Usable width 495 mm

Divider material see page 75

- 450 x 600 mm (W x D) with full pull-out 100% - drawers with 50 mm front height: load capacity 70 kg; drawers from 75 mm front height: load capacity 100 kg



Item no.	Version	Usable heights (mm)
01.050.700EL	left	700
01.050.700ER	right	700
01.050.550EL	left	550
01.050.550ER	right	550

Item no.	Front height (mm)	Shell height (mm)	Usable heights (mm)
60.50.050V07	50	28	30
60.50.075V10	75	56	58
60.50.100V10	100	81	83
60.50.125V10	125	81	108
60.50.150V10	150	131	133
60.50.175V10	175	131	158
60.50.200V10	200	181	183
60.50.250V10	250	181	233
60.50.300V10	300	181	283

Shelf

- When using one or no drawer

Item no.	Dimensions in mm (WxDxH)
01.050.013	497 x 685 x 40



■ 5x drawer

Item no.	Dimensions in mm (WxDxH)
03.15.580.6V	1500 x 750 x 859
03.20.580.6V	2000 x 750 x 859



■ 7x drawer

Item no.	Dimensions in mm (WxDxH)
03.15.580.6-1V	1500 x 750 x 859
03.20.580.6-1V	2000 x 750 x 859



■ 5x drawer

Item no.	Dimensions in mm (WxDxH)
03.15.580.5-1V	1500 x 750 x 859
03.20.580.5-1V	2000 x 750 x 859



■ 1x drawer, 1x hinged door

Item no.	Dimensions in mm (WxDxH)
03.15.580.2V	1500 x 750 x 859
03.20.580.2V	2000 x 750 x 859



■ 6x drawer

Item no.	Dimensions in mm (WxDxH)
03.15.580.8V	1500 x 750 x 859
03.20.580.8V	2000 x 750 x 859



■ 4x drawer

Item no.	Dimensions in mm (WxDxH)
03.15.580.4V	1500 x 750 x 859
03.20.580.4V	2000 x 750 x 859

Inline workbenches with drawer housing 555 x 736 (W x D) | Depth 750 mm

- Drawer interior dimension 450 x 600 mm
- 2x drawer cabinet
- Drawers with full pull-out (FP) 100%
- Drawers with 50 mm front height, load capacity 70 kg
- Drawers from 75 mm front height, load capacity 100 kg
- Load capacity 180 kg on request
- Beech multiplex workbench top, 1500/2000 x 750 x 40 mm
- Cylinder lock with two keys
- 1000 kg total load capacity
- Delivered unassembled, for easy self-assembly



- Left: 5x drawer
- Right: 1x drawer, 1x hinged door

Item no.	Dimensions in mm (WxDxH)
03.15.580.7-1V	1500 x 750 x 859
03.20.580.7-1V	2000 x 750 x 859



- Left: 5x drawer
- Right: 4x drawer

Item no.	Dimensions in mm (WxDxH)
03.15.580.9V	1500 x 750 x 859
03.20.580.9V	2000 x 750 x 859

Individual arrangement

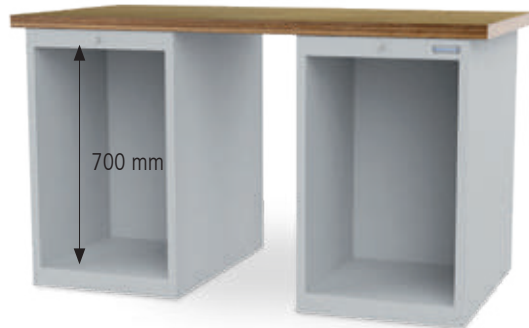

Workbench with 2x empty housing, usable height 700 mm

- Incl. beech multiplex worktop 40 mm

Item no.	Dimensions in mm (WxDxH)
03.15.580.002	1500 x 750 x 859



Workbench with 2x empty housing, usable height 700 mm

- Incl. beech multiplex worktop 40 mm

Item no.	Dimensions in mm (WxDxH)
03.20.580.002	2000 x 750 x 859

Divider material
see page 75



Hinged doors

- Usable width 495 mm

Item no.	Version	Usable heights (mm)
01.050.700EL	left	700
01.050.700ER	right	700
01.050.550EL	left	550
01.050.550ER	right	550

- 450 x 600 mm (W x D) with full pull-out 100% - drawers with 50 mm front height: load capacity 70 kg; drawers from 75 mm front height: load capacity 100 kg

Item no.	Front height (mm)	Shell height (mm)	Usable heights (mm)
60.50.050V07	50	28	30
60.50.075V10	75	56	58
60.50.100V10	100	81	83
60.50.125V10	125	81	108
60.50.150V10	150	131	133
60.50.175V10	175	131	158
60.50.200V10	200	181	183
60.50.250V10	250	181	233
60.50.300V10	300	181	283

Shelf

- When using one or no drawer

Item no.	Dimensions in mm (WxDxH)
01.050.013	497 x 685 x 40



- Left: 5x drawer
- Right: 6x drawer

Item no.	Dimensions in mm (WxDxH)
03.15.580.112V	1500 x 750 x 859
03.20.580.11V	2000 x 750 x 859



- Left: 4x drawer
- Right: 4x drawer

Item no.	Dimensions in mm (WxDxH)
03.15.580.202V	1500 x 750 x 859
03.20.580.20V	2000 x 750 x 859



- Left: 5x drawer
- Right: 7x drawer

Item no.	Dimensions in mm (WxDxH)
03.15.580.212V	1500 x 750 x 859
03.20.580.21V	2000 x 750 x 859



- Left: 6x drawer
- Right: 4x drawer

Item no.	Dimensions in mm (WxDxH)
03.15.580.222V	1500 x 750 x 859
03.20.580.22V	2000 x 750 x 859



- Left: 6x drawer
- Right: 4x drawer

Item no.	Dimensions in mm (WxDxH)
03.15.580.232V	1500 x 750 x 859
03.20.580.23V	2000 x 750 x 859



R 18-24 + R 24-24

- 2x beech multiplex worktop 40 mm
- 3x drawer cabinet
- Left: 4x drawer
- Central: 6x drawer
- Right: 4x drawer

Item no.	Dimensions in mm (WxDxH)
03.30.57.14V	3000 x 750 x 859
03.40.57.14V	4000 x 750 x 859

Inline workbenches

Energy block for inline workbench combinations

Removable door so that all components can be easily maintained.



Front side

Back side

Energy block

- Fully assembled with 1x cable reel and 1x hose reel
- 1x socket panel with 3x earthed sockets and on/off switch
- 2x 1/4" compressed air connections
- Compressed air supply
- Unwired

Item no.	Dimensions in mm (WxDxH)
03.961.2651	200 x 650 x 819

Energy block, empty housing, can be filled from both sides

- Usable height of 750 mm can be used on both sides
- Can be filled with the individual components

Item no.	Dimensions in mm (WxDxH)
03.961.265	200 x 650 x 819

- Reels integrated into the side part offer a total hose/cable length of 6 m
- The door is secured by a cylinder lock and removable so that all components can be easily maintained.

- You can find components to fit for the individual energy supply on/ from page 229
- Delivered unassembled, for easy self-assembly



Inline workbench R 18-24

- Beech multiplex worktop, 1500 x 750 x 40 mm
- Energy block with 1x cable reel and 1x hose reel
- 1x socket panel with 4x earthed sockets
- Base frame made of 50 x 50 x 2 mm square tube
- 1/4" compressed air supply
- Unwired

Item no.	Dimensions in mm (WxDxH)
03.15.000.E1	1500 x 750 x 859
03.20.000.E1	2000 x 750 x 859

Inline workbench R 18-24

- Beech multiplex worktop, 1500 x 750 x 40 mm
- Drawer cabinet: 5x drawer
- Full pull-out 100 %, load capacity 100 kg
- Energy block with 1x cable reel and 1x hose reel
- 1x socket panel with 3x earthed sockets and on/off switch
- 2x compressed air connection
- 1/4" compressed air supply
- Unwired

Item no.	Dimensions in mm (WxDxH)
03.15.580.9E	1500 x 750 x 859
03.20.580.9E	2000 x 750 x 859

You can find further energy components on page 281



Automatic hose reel

- Plastic
- Multi gearlock per rotation
- Incl. 5+1 m PU hose DN 06 and stopper
- Max. pressure 10 bar
- Incl. swivelling mounting plate
- Incl. 1 m connecting hose
- Incl. cover plate

Item no.
03.1.06.06SA



Automatic cable reel

- Plastic
- Protection class IP 24
- Fully insulated, protection against overheating
- With release spring and slip ring
- Incl. 5+1 m cable H05VV-F3G 1.5, earthed plug and coupling, 230 V
- Incl. swivelling mounting bracket
- Incl. cover plate

Item no.
03.0.06.05KA



Cover plate and socket panel

- Cover plate incl. socket panel with 2x earthed sockets

Item no.	Dimensions in mm (W x H)
07.861.14	375 x 125



Cover plate and socket panel

- Cover plate incl. socket panel with 3x earthed sockets with on/off switch

Item no.	Dimensions in mm (W x H)
07.861.15	375 x 125

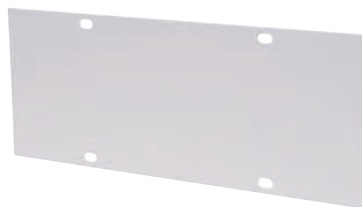

Cover plate

Item no.	Dimensions in mm (W x H)
07.861.04	125 x 125
07.861.05	250 x 125
07.861.06	375 x 125



Cover plate and compressed air

- Cover plate incl. compressed air connection

Item no.	Dimensions in mm (W x H)
07.861.07	1/4" - 125 x 125
07.861.08	1/2" - 125 x 125



Cover plate and socket panel

- Cover plate incl. socket panel with 4x earthed sockets

Item no.	Dimensions in mm (W x H)
07.861.16	375 x 125



Cover plate and emergency stop

- Cover plate incl. emergency stop button

Item no.	Dimensions in mm (W x H)
07.861.09	125 x 125



Cover plate and earthed socket

- Cover plate incl. earthed socket

Item no.	Dimensions in mm (W x H)
07.861.11	125 x 125



Cover plate and CEE socket

- Cover plate incl. CEE socket

Item no.	Dimensions in mm (W x H)
07.861.12	16 A - 250 x 125
CEE32A	32 A - 250 x 125

Other workbenches

Tool dispensing systems

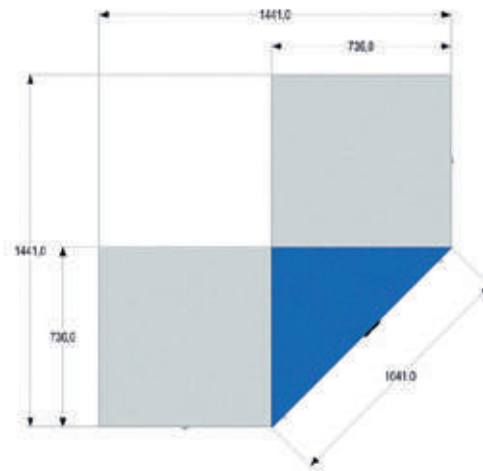

Corner cabinet

- Used for a right-angled arrangement of drawer cabinets
- Stable version made from high-quality sheet metal, with 2x hinged doors 900 mm
- 2x adjustable shelves and cylinder lock with two keys

Item no.	Dimensions in mm (WxDxH)
04.250.20	1050 x 736 x 1019



- Delivered unassembled, for easy self-assembly

Hinged flap

- Beech multiplex 25 mm, incl. hinges

Pos.	Item no.	Dimensions in mm (WxD)
1	04.250.35	705 x 736

Swing door

- Single-leaf (double-leaf on request)
- Beech multiplex 25 mm, incl. door hinges

Pos.	Item no.	Dimensions in mm (WxH)
2	04.250.30	705 x 1019



Drawer cabinets R 18-24 for 6-corner and 8-corner benches

Dimensions in mm (W x D x H) 555 x 736 x 819 mm

Drawers with full pull-out (FP) 100%

Drawers with 50 mm front height, load capacity 70 kg

Drawers from 75 mm front height, load capacity 100 kg



- 1x drawer
- 1x hinged door

Item no.
580/0010.550V



- 3x drawer
- 1x hinged door

Item no.
580/0300.400V



- Drawer cabinet, divided, 2x drawer each

Item no.
580/2.0040V



- Drawer cabinet, divided, 3x drawer each

Item no.
580/2.0600V

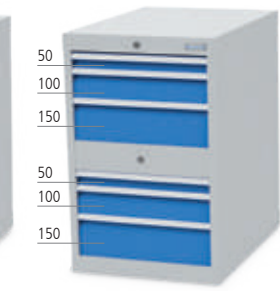

- Drawer cabinet, divided, 3x drawer each

Item no.
580/2.1110V



- 1x hinged door
- 1x Shelf

Item no.
580/0001FL



- 2x drawer
- 1x hinged door

Item no.
580/0110/450V



- 5x drawer

Item no.
580/0140V



- Drawer cabinet, divided, 1x drawer each

Item no.
580/2.0002V



- Drawer cabinet, divided, 2x drawer each

Item no.
580/2.0202V

Other workbenches

6-corner group workplaces

New

Delivered unassembled, for easy self-assembly

6-corner-worktop

- Beech multiplex 40 mm

Item no.	Dimensions in mm (WxDxH)
03.15.66	2500 x 2165 x 40

Intermediate plate

- Mounting between two drawer cabinets

Item no.	Dimensions in mm (WxDxH)
03.58.20	101 x 30 x 815

Drawer cabinets

- Dimensions in mm (W x D x H) 555 x 736 x 819 mm
- Drawers with full pull-out 100 %
- Drawers with front height 50 mm - load capacity 70 kg
- Drawers with front height 75 mm and more - load capacity 100 kg

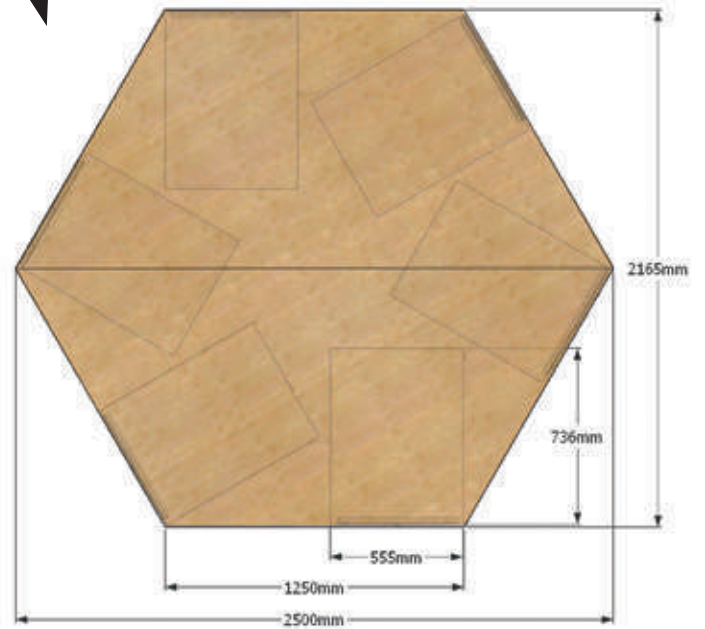

6-corner-workbench

- 6 x drawer cabinet R18-24, each 2 x drawer 100 mm, 2 x 150 mm, 1 x 200 mm
- 6 x Intermediate plate, between two drawer cabinets
- 1 x 6-corner workbench top, beech multiplex worktop 40 mm

Item no.	Dimensions in mm (WxDxH)
03.66.05V	2500 x 2165 x 859



6-corner-workbench

- 6 x drawer cabinet R18-24, each 1 x drawer 50 mm, 1 x 100 mm, 1 x 150 mm (above and below)
- 6 x Intermediate plate
- 1 x 6-corner workbench top, beech multiplex 40 mm

Item no.	Dimensions in mm (WxDxH)
03.66.2.111V	2500 x 2165 x 859

6-corner-workbench

- 6 x drawer cabinet R18-24, each 1 x drawer 100 mm, 1 x 150 mm 1 x hinged door 500 mm
- 6 x Intermediate plate
- 1 x 6-corner workbench top, beech multiplex 40 mm

Item no.	Dimensions in mm (WxDxH)
03.66.11/450V	2500 x 2165 x 859



BZI, Remscheid



03.66.73-3



New

6-corner energy ramp

Item no.	Description
03.66.73-1	6-corner energy ramp, 6 x socket panel with 2 x earthed socket, 6x 1/4" compressed air connection, unwired, 825 x 715 x 165 mm (W x D x H)
03.66.73-3	6-corner energy ramp, 6 x socket panel with 2 x earthed socket, unwired, 825 x 715 x 165 mm (W x D x H)
03.66.73/BL	6-corner energy ramp, empty, unequipped and unwired, 6x 375 mm wide
03.66.73/BL2	6-corner energy ramp two-story, empty, unequipped and unwired, 12x 375 mm wide
07.861.12	Cover plate incl. CEE socket 16 A, 250 mm wide
07.861.19	Cover plate incl. network socket, RJ45 socket, 125 mm wide
07.861.07	Cover plate incl. compressed air, 1/4", 125 mm wide
07.861.21	Cover plate incl. socket panel, socket panel with 2 x earthed socket, 250 mm wide
07.861.08	Cover plate incl. compressed air, 1/2", 125 mm wide
07.861.11	Cover plate incl. socket panel with 1 x earthed socket, 125 mm wide
07.861.14	Cover plate incl. socket panel with 2 x earthed socket, 375 mm wide
07.861.15	Cover plate incl. socket panel with 3 x earthed socket and on/off switch, 375 mm wide
07.861.16	Cover plate incl. socket panel with 4 x earthed socket, 375 mm wide

Other workbenches

8-corner group workplaces

Delivered unassembled, for easy self-assembly

8-corner-worktop

- Beech multiplex 40 mm

Item no.	Dimensions in mm (WxDxH)
03.15.88	3020 x 3020 x 40

Intermediate plate

- Mounting between two drawer cabinets

Item no.	Dimensions in mm (WxDxH)
03.58.21	261 x 30 x 815

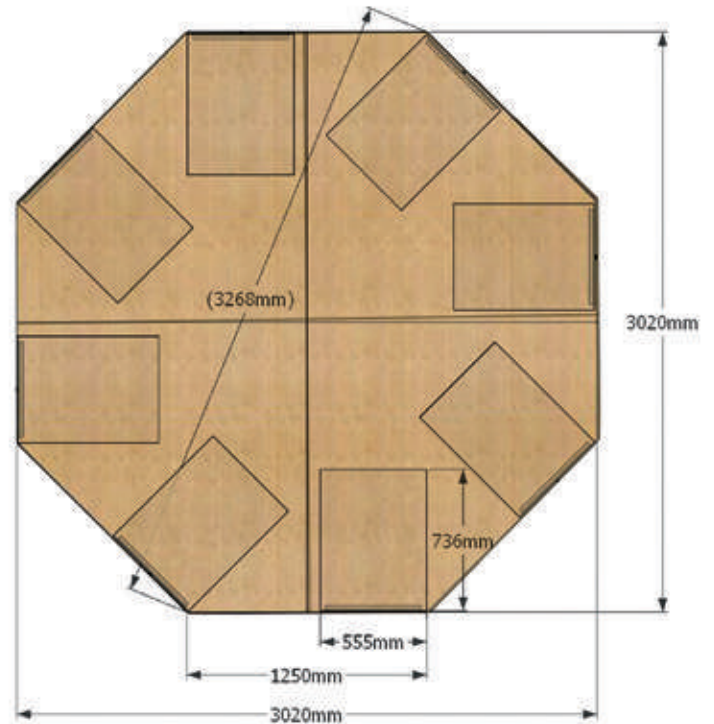

Drawer cabinets

- Dimensions in mm (W x D x H): 555 x 736 x 819 mm
- Drawers with full pull-out 100 %, load capacity 100 kg



8-corner-workbench

- 8 x drawer cabinet R18-24, each 7 x drawers 100 mm
- 8 x Intermediate plate
- 1 x 8-corner workbench, top beech multiplex 40 mm

Item no.	Dimensions in mm (WxDxH)
03.88.05V	3020 x 3020 x 859

New

**8-corner-workbench**

- 8 x drawers R18-24, each 3 x drawers 100 mm, 1 x hinged door 400 mm
- 8 x Intermediate plate
- 1 x 8-corner workbench top, beech multiplex 40 mm

Item no.	Dimensions in mm (WxDxH)
03.88.3/400V	3020 x 3020 x 859



03.88.73-1



New

8-corner energy ramp

Item no.	Description
03.88.73-1	8-corner energy ramp, 8 x 1/4" compressed air connector, 8 x socket panel with 2 x earthed socket, unwired, 1075 x 995 x 165 mm, 8 x 375 mm
03.88.73/BL	8-corner energy ramp, empty, unequipped and unwired, 1075 x 995 x 165 mm, 8 x 375 mm wide
03.88.73/BLB	8-corner energy ramp, empty, unequipped and unwired, 1570 x 1450 x 165 mm, 8 x 500 mm wide
07.861.12	Cover plate incl. CEE socket 16 A, 250 mm wide
07.861.19	Cover plate incl. network socket, RJ45 socket, 125 mm wide
07.861.07	Cover plate incl. compressed air, 1/4", 125 mm wide
07.861.08	Cover plate incl. compressed air, 1/2", 125 mm wide
07.861.11	Cover plate incl. socket panel with 1 x earthed socket, 125 mm wide
07.861.14	Cover plate incl. socket panel with 2 x earthed socket, 375 mm wide
07.861.15	Cover plate incl. socket panel with 3 x earthed socket and on/off switch, 375 mm wide
07.861.16	Cover plate incl. socket panel with 4 x earthed socket, 375 mm wide

Additional components s. page 238

Workbench accessories



ON THE WORKBENCH



Energy duct

Seite 238



Worktop covers

Page 240



Universal "on the workbench" accessories

Page 241



Vices and accessories

Page 242



Open fronted storage bins, information boards

Page 248

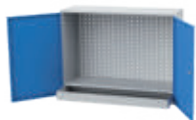

Open fronted storage bins, info boards

Page 252

UNDER THE WORKBENCH



Universal "under the workbench" accessories

Page 253



Workplace mats, wooden grating

Page 254



Flex-box and hanging base cabinets

Page 255



Workbench accessories ON THE WORKBENCH

Energy duct



Energy duct, empty

- Universal applicable
- Fuses s. page 284
- Unwired
- The width of the individual cover plates added together equals the width of the energy duct

Item no.	Dimensions in mm (WxDxH)	Systemmaß in mm
07.861.501	375 x 60 x 130	-
07.861.500	500 x 60 x 130	-
07.861.701	625 x 60 x 130	750
07.861.801	875 x 60 x 130	1000
07.861.1251	1125 x 60 x 130	1250
07.861.1301	1375 x 60 x 130	1500
07.861.1751	1625 x 60 x 130	1750
07.861.1801	1875 x 60 x 130	2000

New



Energy duct, empty

- 45° inclination
- For mountin on the worktop
- Fuses s. page 284
- Unwired
- The width of the individual cover plates added together equals the width of the energy duct

Item no.	Dimensions in mm (WxDxH)
07.861.100S	1000 x 150 x 150
07.861.125S	1250 x 150 x 150
07.861.150S	1500 x 150 x 150
07.861.200S	2000 x 150 x 150

Energy duct mounting bracket for mounting on the worktop

- Mounting brackets for direct mounting on worktop (pair)



Item no.	Dimensions in mm (WxDxH)
03.861.04	60 x 52 x 110

New



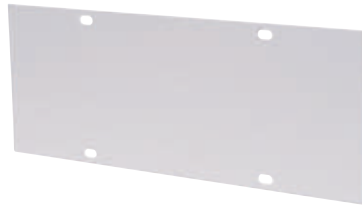

Cover plate for the energy duct

Item no.	Dimensions in mm (WxH)
07.861.04	125 x 125
07.861.05	250 x 125
07.861.06	375 x 125



Cover plate and socket panel

- Cover plate incl. socket panel with 3x earthed sockets with on/off switch

Item no.	Dimensions in mm (WxH)
07.861.15	375 x 125



Cover plate and socket panel

- Cover plate incl. socket panel with 4x earthed socket

Item no.	Dimensions in mm (WxH)
07.861.16	375 x 125



Cover plate and socket panel

- Cover plate incl. socket panel with 2x earthed socket

Item no.	Dimensions in mm (WxH)
07.861.21	250 x 125



USB port

- Cover plate incl. USB A and USB C port

Item no.	Dimensions in mm (WxH)
07.861.33	125 x 125



USB port

- Cover plate incl. earthed socket, USB A and USB C port

Item no.	Dimensions in mm (WxH)
07.861.26	125 x 125



Cover plate and network socket

- Cover plate incl. RJ45 socket

Item no.	Dimensions in mm (WxH)
07.861.19	125 x 125



Cover plate and toggle switch

- Cover plate incl. toggle switch

Item no.	Dimensions in mm (WxH)
07.861.10	125 x 125



Cover plate and CEE socket

- Cover plate incl. CEE socket

Item no.	Dimensions in mm (WxH)
07.861.12	16 A - 250 x 125
CEE32A	32 A - 250 x 125



Cover plate and emergency stop

- Cover plate incl. emergency stop button

Item no.	Dimensions in mm (WxH)
07.861.09	125 x 125



Cover plate and earthed socket

- Cover plate incl. earthed socket

Item no.	Dimensions in mm (WxH)
07.861.11	125 x 125



Cover plate and compressed air

- Cover plate incl. compressed air connection

Item no.	Dimensions in mm (WxH)
07.861.07	1 / 4" - 125 x 125
07.861.08	1 / 2" - 125 x 125

Workbench accessories ON THE WORKBENCH

Worktop covers



High-strength non-slip mat for use as a worktop cover, transport securing device and floor mat, made from highly tear-proof PES base material with PVC soft foam special coating.

The "Panther" anti-slip mat is produced in accordance with the latest EU regulations "Restriction of Hazardous Substances" and is free of azo dyes, formaldehyde, silicon and poisonous heavy metals such as lead and cadmium.

Processing: The non-slip mat can be cut with the cutter, perforated with a punch, nailed, riveted and screwed.

Other dimensions on request.

Safety non-slip mats as workbench coverings

Item no.	Dimensions in mm (WxDxH)
0310754ANT	1000 x 750 x 4
0312754ANT	1250 x 750 x 4
0315754ANT	1500 x 750 x 4
0320754ANT	2000 x 750 x 4
0325754ANT	2500 x 750 x 4
Cpl. roll	
0340604ANT	600 x 4000 x 4
0340804ANT	800 x 4000 x 4
0340104ANT	1000 x 4000 x 4
Adhesive	
0340604SANT	600 x 4000 x 4
0340804SANT	800 x 4000 x 4

Advantages:

- Temperature resistance approx. -40 °C to +120 °C
- Closed surface – no absorption of liquids
- Excellent resistance to acids, lyes, oil, petrol and diesel
- Melting temperature approx. 250 °C, auto-ignition temperature approx. 350 °C
- Cleaning: wipe with a damp cloth and a solvent-free cleaning agent. Rinse thoroughly with water and allow to dry.



Processing: soft PVC material can be cut with the cutter, perforated with a punch, nailed, riveted and glued with special adhesive.

Properties: Soft PVC, bluish- transparent, glossy and flexible

Normal quality, Shore A approx 80°

Temperature-resistant from -20 °C to +60 °C

UV-stabilised

DOP-, cadmium and silicone free

Soft PVC workbench coverings

- Transparent
- Bluish

Item no.	Dimensions in mm (WxDxH)
0310754TRA	1000 x 750 x 4
0312754TRA	1250 x 750 x 4
0315754TRA	1500 x 750 x 4
0320754TRA	2000 x 750 x 4
0325754TRA	2500 x 750 x 4

Advantages:

- Particularly long life
- High wear resistance
- Easy to clean
- Recyclable
- VOC values according to European standard

**Rotary plate**

- Without locking mechanism
- With ribbed rubber mat



Item no.	Dimensions in mm
07.60.380A	Ø 380
07.60.370A	Ø 500

**Rotary plate with locking mechanism**

- With locking mechanism every 45°
- With ribbed rubber mat



Item no.	Dimensions in mm
07.60.38	Ø 380
07.60.37	Ø 500
07.60.38ESD	Ø 380, ESD-version
07.60.37ESD	Ø 500, ESD-version

**Frame attachment**

- For screwing onto the workbench top

Item no.	For table width	Dimensions in mm (DxH)
03.12.98	1200 mm	300 x 360
03.15.98	1500 mm	300 x 360
03.20.98	2000 mm	300 x 360
03.25.98	2500 mm	300 x 360

**Shelf, 3rd level**

- Beech multiplex 25 mm

Item no.	Dimensions in mm (WxDxH)
07.25.33	1000 x 260 x 300
07.25.35	1500 x 260 x 300

Roller shutter attachment cabinet for mounting on the workbench

- Incl. 2x perforated wall

Item no.	Dimensions in mm (WxDxH)
03.990.01.14	910 x 220 x 820

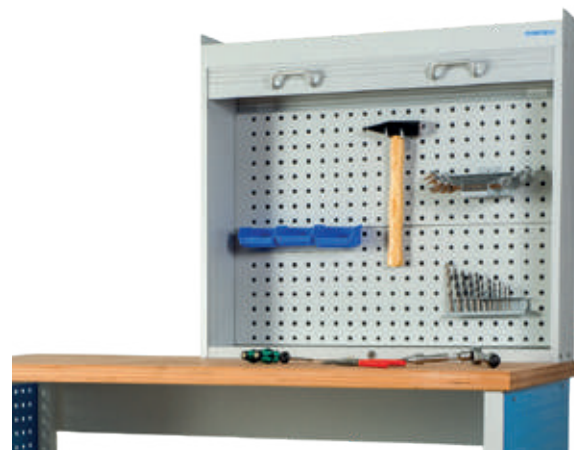

Scope of delivery without decoration

Workbench accessories ON THE WORKBENCH

Workbench accessories, heavy version



Vice Mondial

- Forged from steel
- Jaws interchangeable
- Induction hardened, knurled jaws
- Ground surfaces
- Burnished threaded wrench
- Induction hardened and ground Anvil
- Induction hardened and ground sliding parts
- With adjusting screws
- Opening to the front.
- Color similar to RAL 5001

Item no.	Jaw width in mm
03.M88.100	100
03.M88.125	125
03.M88.150	150
03.M88.175	175



Rotary plate for vice Mondial

- Swivels 360°
- With 2x locking lever

Item no.	Jaw width in mm
03.M88.101	100
03.M88.121	125
03.M88.151	150
03.M88.171	175



Lift for vice Mondial

- The vice can be effortlessly, quickly and safely adjusted up to a height of 215 mm by means of a gas pressure spring and can be rotated 360°.
- The lift can also be used for other types of vices.

Item no.	Jaw width in mm
03.M88.102	100
03.M88.122	125
03.M88.152	150
03.M88.172	175



Vice MG/10

- Made of special cast iron G22
- Dovetail guide
- Replaceable jaws made of steel, knurled and hardened.
- Opening to the rear

Item no.	Jaw width in mm
03.M89.080	80
03.M89.100	100
03.M89.120	120
03.M89.150	150



Rotary plate for Vice MG/10

- Swivels 360°

Item no.	Jaw width in mm
03.M89.081	80
03.M89.101	100
03.M89.121	120
03.M89.151	150



Lift for vice MG/10

- The vice can be effortlessly, quickly and safely adjusted up to a height of 215 mm by means of a gas pressure spring and can be rotated 360°.
- The lift can also be used for other types of vices.

Item no.	Jaw width in mm
03.M89.082	80
03.M89.102	100
03.M89.122	120
03.M89.152	150

**LEINEN - Vice Junior**

- Maximum stability due to high-strength solid gray cast iron (G 25)
- Cast-on clamping jaws
- With interchangeable jaws. Jaws have one knurled and one smooth side and can be turned around as required
- Absolutely backlash-free movement of upper and lower part due to precision-machined dovetail guide
- Safe guidance even in wide open condition
- High impact resistance and long service life
- Special jaw locking, thus no jaw position change and loosening under impact load
- Cross slide precisely adjustable due to smooth-running, backlash-free spindle operation
- Parallel jaws in toolmaker quality, even after years of use
- Problem-free conversion from „fixed“ to „rotating“ design
- Opening to the rear
- Hammer finish according to RAL 6011/ also available in RAL 5007.

Item no.	Jaw width in mm
03.89.100	100
03.89.125	125
03.89.150	150

**Rotary plate**

- Swivels 360°
- Also available in RAL 5007

Item no.	Backenbreite in mm
03.89.101	100
03.89.102	125
03.89.105	150

**LEINEN - Lift**

- The vice can be effortlessly, quickly and safely adjusted up to a height of 215 mm by means of a gas pressure spring and can be rotated 360°.
- The LEINEN lift can also be used for other types of vices..
- Also available in RAL 5007

Item no.	Backenbreite in mm
03.89.111	100
03.89.122	125
03.89.155	150

Workbench accessories ON THE WORKBENCH

Workbench accessories, lightweight version



Panther vice

- Jaws forged and hardened.
- Induction hardened, knurled jaws. Ground surfaces
- Burnished threaded wrench
- Induction hardened and ground anvil
- Induction hardened and ground sliding parts
- Adjustment screws
- Opening to the front
- Color similar to RAL 5009

Item no.	Jaw width in mm
03.88.100	100
03.88.120	120
03.88.140	140
03.88.160	160

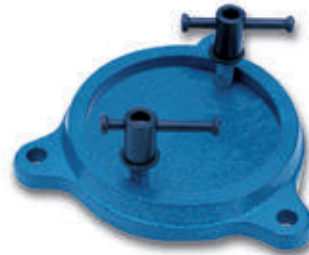

Panther rotary plate

- Swivels 360°.
- With 2x locking lever.

Item no.	Jaw width in mm
03.88.101	100
03.88.102	120
03.88.103	140
03.88.104	160



Panther lift

- The vice can be effortlessly, quickly and safely adjusted up to a height of 215 mm by means of a gas pressure spring and can be rotated 360°.
- The lift can also be used for other types of vices.

Item no.	Jaw width in mm
03.88.111	100
03.88.122	120
03.88.144	140
03.88.166	160



Collapsible lift for Panther vice

- The vice can be effortlessly, quickly and safely adjusted up to a height of 215 mm by means of a gas pressure spring and can be rotated 360°.
- In the twinkling of an eye, the vice can be lowered under the workbench with the help of the lift, thus creating a free working area.
- Suitable for vice PANTHER with 120 mm jaw width.

Item no.	Jaw width in mm
03.88.170	120

Vice H entirely forged from steel

- Galvanized spindle wrench with riveted steel retaining rings
- Drop-forged front jaw, protected precision spindle bearings
- Surface hardened clamping jaws
- Slim but stable guide rail
- Tube clamping jaws forged on as standard
- Drop-forged rear jaw with shape-optimized anvil
- Forged-on strong spindle nut
- Drop-forged guide plates
- Adjustable guide via central screw
- Double, internal prismatic guide, thus no contamination and damage



Item no.	Jaw width in mm	Clamping width in mm	Clamping depth in mm	Clamping jaws for tube outside diameter in mm	Weight in kg
03.84.100	100	125	50	16-30	4,5
03.84.120	120	150	65	16-55	9
03.84.140	140	200	80	27-70	16
03.84.160	160	225	100	27-100	27



Lift for vice H

- Height adjustable by 200 mm

Item no.	For jaw width in mm	Load capacity in kg	Weight in kg
03.86.100	100	4-10	8
03.86.120	120	4-10	8
03.86.140	140	10-16	9
03.86.160	160	16-29	9



Tilting device for vice H

Item no.	For jaw width in mm	Lowest point in mm	Folding depth in mm	Weight in kg
03.86.121	120	590	460	11,5
03.86.141	140	630	495	11,9



Housing for collapsible vice lift

- Lockable housing
- Lock can be mounted left or right
- Front plastic roller shutter
- Usable dimension 260 x 475 x 680 mm

Item no.	Dimensione in mm (WxDxH)
03.84.04	300 x 500 x 819

Collapsible lift for vice H

Item no.	For jaw width in mm	Lowest point in mm	Folding depth in mm	Load capacity in kg	Weight in kg
03.85.120	120	590	460	4-10	14
03.85.140	140	630	495	10-16	11,9

100 mm base for vice housing

Item no.	Dimensione in mm (WxDxH)
03.84.07	300 x 500 x 100

Workbench accessories ON THE WORKBENCH

Workbench accessories



MAGNEFIX

The new MAGNEFIX protective jaws provide a firm but gentle grip and are the best choice even for demanding craftsmen. The MAGNEFIX jaws are right-angled, surface-parallel and suitable for all vices, including machine vices, making them equally suitable for production as assembly work. MAGNEFIX protective jaws are equipped with extremely strong magnetic strips for quick and easy assembly. The magnetic strip is only magnetic against the vise and therefore does not attract iron filings and dirt. In addition, the workpiece is not magnetized.

Advantages:

- Shockproof extruded polycarbonate
- Extremely powerful neodymium magnetic strip
- Holding force for a 100-mm wide protective jaw is 3.5 kg, corresponding to 34N
- Hardened aluminum 6063, T66F25 with magnesium and silicon as alloy components
- Provides superior corrosion protection with first-class surface finish and is ideally suited for firm clamping in a vise while protecting delicate workpieces

PRISMATIC PROTECTIVE JAWS

The MAGNEFIX prismatic protective jaws are designed for versatile use and offer efficient clamping while protecting the workpiece.

Designed for

- horizontal clamping of flat workpieces
- horizontal clamping of round workpieces
- vertical clamping of round workpieces

For thread cutting, it's recommended using only one protective jaw with prisms to prevent damage to the jaw. The keyway aligns the workpiece, while the fluting of the opposite vise jaw prevents rotation.



90° recess at the top for clamping of flat bars during marking or center punching.



Horizontal 120° V-groove for clamping tubes and other round workpieces.



Three vertical V-grooves with 100°, 120° and 130° for clamping tubes and other round workpieces.

New

**MAGNEFIX N**

- Neutral protective jaws made of hardened aluminum
- For the clamping of coarse or medium coarse workpieces

Item no.	Für Backenbreite in mm
03.06.0100	100
03.06.0120	120
03.06.0125	125
03.06.0140	140
03.06.0150	150
03.06.0160	160
03.06.0180	180

**MAGNEFIX P**

- Prismatic pipe protection jaws made of hardened aluminum
- For easy centering

Item no.	Für Backenbreite in mm
03.06.3100	100
03.06.3120	120
03.06.3125	125
03.06.3140	140
03.06.3150	150
03.06.3160	160
03.06.3180	180

**MAGNEFIX F**

- Protective jaws made of hardened aluminum with fiber cover
- For highly processed workpieces

Item no.	Für Backenbreite in mm
03.06.2100	100
03.06.2120	120
03.06.2125	125
03.06.2140	140
03.06.2150	150
03.06.2160	160
03.06.2180	180

**MAGNEFIX G**

- Neutral protective jaws made of hardened aluminum
- For the clamping of coarse or medium coarse workpieces

Item no.	Für Backenbreite in mm
03.06.1100	100
03.06.1120	120
03.06.1125	125
03.06.1140	140
03.06.1150	150
03.06.1160	160
03.06.1180	180

PROTECTIVE JAWS MADE OF POLYURETHANE

The protective jaws are made of highly flexible polyurethane with a Shore hardness of A82. Polyurethane is known for its unique ability to „bite“ into the workpiece without damaging or scratching it. At the same time, it's extremely flexible, so it easily returns to its original shape after deformation.

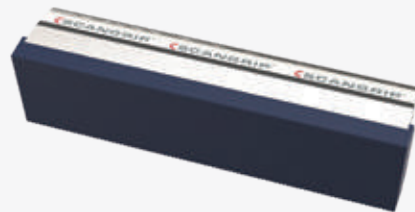
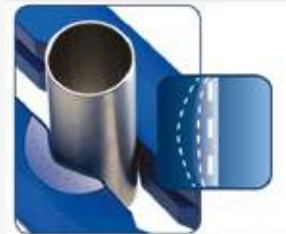
**MAGNEFIX RUF**

- Fluted protective jaws made of polyurethane
- For clamping flat workpieces with very delicate details
- For a firm grip

Item no.	Für Backenbreite in mm
03.06.4100	100
03.06.4125	125
03.06.4140	140
03.06.4150	150

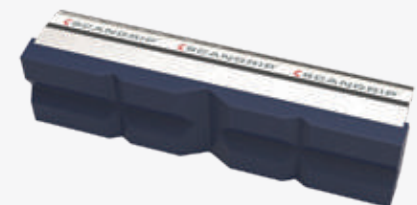
**MAGNEFIX PUP**

- Fluted protective jaws made of polyurethane
- For clamping flat workpieces with very delicate details

Item no.	Für Backenbreite in mm
03.06.5100	100
03.06.5125	125
03.06.5140	140
03.06.5150	150

Workbench accessories ON THE WORKBENCH

Transport and stacking containers

- Stackable, made of high-quality polypropylene, comply with the provisions of the German Food Law
- Suitable for small roller conveyors
- Container size coordinated to pallet dimensions 1200 x 800 mm
- Material: polypropylene

Euro storage bins

- Polypropylene
- Colour: blue



Item no.	Dimensions in mm (WxDxH)
03.55498	300 x 400 x 120
03.55501	300 x 400 x 170
03.55504	300 x 400 x 220



300 x 200 x 75



300 x 200 x 145



400 x 300 x 75



400 x 300 x 120

Closed walls and bottom, made of polypropylene

Transport and stacking containers made of polypropylene, comply with the provisions of the German Food Law

		Dimensions in mm (WxDxH)			
		Exterior	200 x 300 x 145	400 x 300 x 75	400 x 300 x 120
		Interior	157 x 255 x 65	152 x 252 x 133	356 x 255 x 110
Red	Item no.	078000201	077000201	075750201	075120201
Blue	Item no.	078000202	077000202	075750202	075120202
Green	Item no.	078000203	077000203	075750203	075120203
Yellow	Item no.	078000204	077000204	075750204	075120204
Grey	Item no.	078000205	077000205	075750205	075120205



400 x 300 x 145



400 x 300 x 175



400 x 300 x 210



400 x 300 x 270

Closed walls and bottom, made of polypropylene

Transport and stacking containers made of polypropylene, comply with the provisions of the German Food Law

		Dimensions in mm (WxDxH)				
		Exterior	300 x 400 x 145	300 x 400 x 175	300 x 400 x 210	300 x 400 x 270
		Interior	255 x 356 x 135	255 x 356 x 165	255 x 356 x 200	255 x 356 x 255
Red	Item no.	075000201	075170201	074210201	074000201	
Blue	Item no.	075000202	075170202	074210202	074000202	
Green	Item no.	075000203	075170203	074210203	074000203	
Yellow	Item no.	075000204	075170204	074210204	074000204	
Grey	Item no.	075000205	075170205	074210205	074000205	



Closed walls and bottom, made of polypropylene

Transport and stacking containers made of polypropylene, comply with the provisions of the German Food Law

		Dimensions in mm (WxDxH)					
		400 x 600 x 75	400 x 600 x 120	400 x 600 x 145	400 x 600 x 175	400 x 600 x 210	400 x 600 x 270
		352 x 551 x 65	352 x 551 x 110	352 x 551 x 133	352 x 551 x 165	352 x 551 x 200	352 x 551 x 255
Red	Item no.	072750201	072120201	072000201	072170201	071210201	071000201
Blue	Item no.	072750202	072120202	072000202	072170202	071210202	071000202
Green	Item no.	072750203	072120203	072000203	072170203	071210203	071000203
Yellow	Item no.	072750204	072120204	072000204	072170204	071210204	071000204
Grey	Item no.	072750205	072120205	072000205	072170205	071210205	071000205



Plastic open fronted storage bins

Stackable, made of high-quality polypropylene, comply with the provisions of the German Food Law. All containers can be fitted with slide-in labels.

		Dimensions in mm (WxDxH)					
		102 x 90/76 x 50	105 x 164/150 x 75	150 x 230/205 x 125	150 x 290/265 x 125	213 x 330/301 x 150	213 x 330/297 x 200
		87 x 70 x 43	85 x 135 x 62	122 x 194 x 113	122 x 254 x 113	179 x 280 x 137	179 x 280 x 185
Red	Item no.	019500221	018500221	017500221	016500221	015500221	014500221
Blue	Item no.	019500222	018500222	017500222	016500222	015500222	014500222
Green	Item no.	019500223	018500223	017500223	016500223	015500223	014500223
Yellow	Item no.	019500224	018500224	017500224	016500224	015500224	014500224
Grey	Item no.	019500225	018500225	017500225	016500225	015500225	014500225
Packing unit		50	25	25	25	10	10

*With suspension for holding rails and slotted panels

Workbench accessories ON THE WORKBENCH

Info boards



Info board A5, Wall 10

- Complete set made of powder-coated sheet steel, for wall mounting
- Metal wall bracket with 10 display panels
- A5 format (10 pieces in black)
- Tab with blank insert labels

Item no.	Version
5507	Black



Info board A4, Wall 20

- Complete set made of powder-coated sheet steel, for wall mounting
- Metal wall bracket with 20 display panels
- A4 format (5 pieces in each colour: red, yellow, green and dark blue)
- Tab with blank insert labels

Item no.	Version
5512	Assorted colours



Info board A4, Wall 5

- Complete set made of powder-coated sheet steel, for wall mounting
- Metal wall bracket with 5 display panels
- A4 format
- Tab with blank insert labels

Item no.	Version
5551R	Red
5551B	Blue
5551O	Orange



Info board A4, Wall 10

- Complete set made of powder-coated sheet steel, for wall mounting
- Metal wall bracket with 10 display panels
- A4 format (2 pieces in each colour: black, red, yellow, green and dark blue)
- Tab with blank insert labels

Item no.	Version
5567	Assorted colours



Info panel A4

- Polypropylene display panels with all-round, coloured profile frame with 5 display panels
- DIN A4 format (5 pieces in each colour: black, red, yellow, green, dark blue, orange, grey, graphite, blue, violet)

Item no.	Version
5606	Assorted colours



Magnetic Info board A4, Wall 5

- Metal wall bracket with magnetic back with 5 display panels
- A4 format
- Can be quickly and easily attached to metallic substrates such as racks or machines

Item no.	Version
5914	Black

Sorting racks and magnetic frames

Workbenches

Metal sorting racks for the clear sorting of documents. Available in multiple colour and sizes. Ideal for wall mounting, includes fastening material, also suitable for desktop use
Label window on the side



- Sorting rack with 5 compartments
- For A4/folio format
- Powder-coated steel
- (WxDxH): 360 x 250 x 330 mm

Item no.	Version
3360-01	Black
3360-10	Grey



- Sorting rack with 8 compartments
- For A4/folio format
- Powder-coated steel
- (WxDxH): 360 x 250 x 540 mm

Item no.	Version
3361-01	Black
3361-10	Grey

Magnetic frame

For the clear presentation of information

- Material: anti-reflective rigid film, thickness 240 my
- Can be used in profile and landscape format
- Frames adhere to all ferrous surfaces
- Scratch-proof frame print
- Back completely sealed with magnets
- Paper can be changed extremely quickly (lift one corner - change paper - let go of corner - done)
- Example applications: Notices on whiteboards, signs on control cabinets and in lockers



Magnetic label bag

- Bag of 50 pieces
- Made of durable PP with two magnet strips for attachment to metallic surfaces such as storage racks
- Scanner-friendly and waterproof
- Blue

Item no.	Internal dimensions (HxW) in mm	External dimensions
1741-07	38 x 100	50 x 110
1742-07	67 x 150	80 x 160

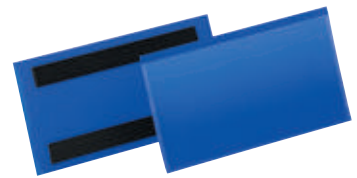

- Magnetic frame A3
- Bag of 5 pieces

Item no.	Version
4868-01	Black
4868-03	Red
4868-07	Dark blue
4868-23	Silver/grey



- Security magnetic frame A4
- Bag of 5 pieces

Item no.	Version
4945-130	Yellow/black
4945-131	Green/white
4945-132	Red/white



- Magnetic frame A4
- Bag of 5 pieces

Item no.	Version
4869-01	Black
4869-03	Red
4869-07	Dark blue
4869-23	Silver/grey

Workbench accessories ON THE WORKBENCH

Wall-mounted hanging tool cabinets

- Stable sheet steel construction
- Rear wall with square perforation
- Square perforation 10x10 mm
- Spacing from hole middle to hole middle 38 mm
- Doors can hinged on the right or left
- Cylinder lock with two keys
- Mounting on the wall with dowels and screws

New



Single shelf for wall-mounted hanging tool cabinet

Item no.	Dimensions in mm (WxDxH)
03.87WFB	490 x 180 x 20
03.87.WFB1000	990 x 290 x 20



- 1x hinged door, 700 mm

Item no.	Dimensions in mm (WxDxH)
03.87W500	500 x 200 x 750

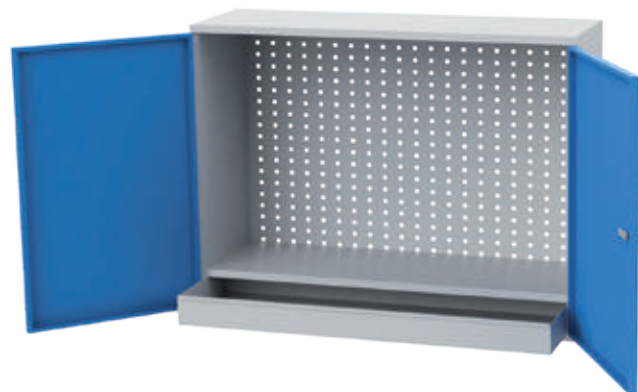

- 2x hinged door, 700 mm
- 1x drawer FH 75 mm, full pull-out 100%, load capacity 15 kg
- 1x shelf, 990 mm

Item no.	Dimensions in mm (WxDxH)
03.87W1000S	1000 x 310 x 750

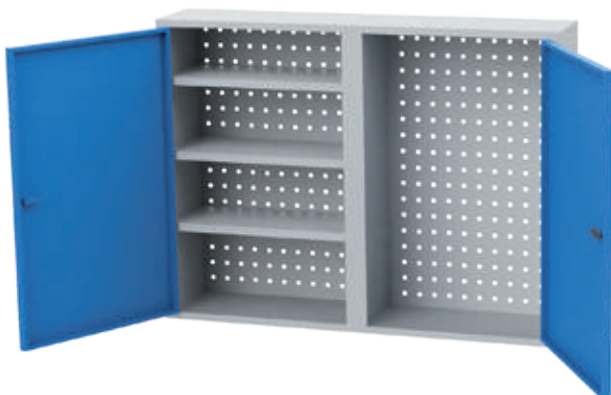

- 2x hinged door, 700 mm
- 1x partition wall
- 3x shelf

Item no.	Dimensions in mm (WxDxH)
03.87W1000	1000 x 200 x 750



- 3x hinged door, 700 mm
- 2x partition wall
- 4x shelf

Item no.	Dimensions in mm (WxDxH)
03.87W1500	1500 x 200 x 750



Keyboard tray

- Support surface: 500 x 300 mm (WxD)
- Chipboard coated on both sides, 16 mm with edging

Item no.	Dimensions in mm (WxDxH)
07.2036	600 x 300 x 70

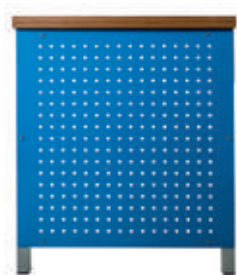

Perforated side wall for box workbench frame

- For one side

Item no.	Dimensions in mm (W x H)
03.83.736	731 x 720

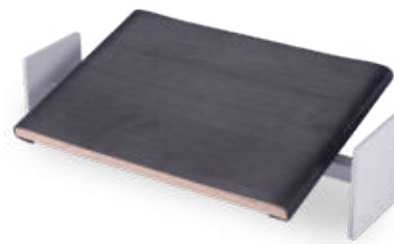

Footrest

- Freestanding, inclined

Item no.	Dimensions in mm (WxDxH)
07.89.09	600 x 300



Footrest

- Individually adjustable height and incline

Item no.	Dimensions in mm (WxDxH)
07.00.30	470 x 410 x 430



PC support H

- For attachment under the worktop
- Width adjustable

Item no.	Dimensions in mm (WxDxH)
07.89.06	250 x 550 x 500

Workbench accessories UNDER THE WORKBENCH

Workplace mats

Preventive health protection by ensuring that workers stand in a safe and healthy way

- High wear resistance
- Good low-temperature behaviour
- Exceptional ageing resistance
- Durability
- Excellent dimensional stability
- Wear resistance
- Environmental compatibility (free of silicon, CFCs, HCFCs, PVC, propellants and solvents)
- Special dimensions possible

- Standard PU colour: anthracite grey.
Additional charge for coloured mats (opal green + ultramarine blue)
- Weight: 3 kg
- 600 x 900 mm
- Temperature resistance: -40°C to +80°C
- Electrical resistance: 106 Ω (ESD)



1 STANDARD	2 DREHFIT	3 DUOFIT	4 HYDROFIT
-------------------	------------------	-----------------	-------------------

Front view

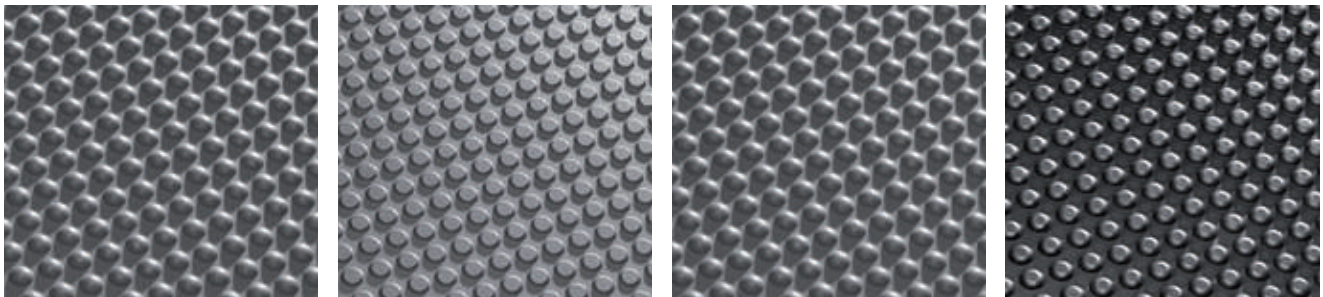

Rear view

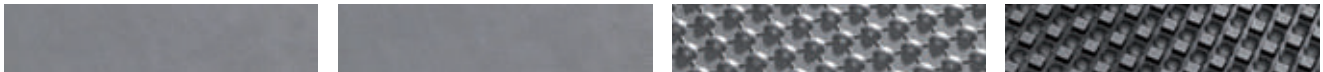

Pos.	Item no.	Dimensions in mm (WxD)	Version
1	05.BM.101	600 x 900 mm with 2 cm leading edge* on each side.	Standard <u>classic version</u> , surface with round nubs, smooth underneath. Standard PU version for dry areas
1	05.BM.101-2		Standard <u>comfort version</u> , polyether-based or anti-static (for additional charge)
2	05.BM.102	Total size: 640 x 940 mm	DREHFIT <u>classic version</u> , flattened nubs on the top, smooth underneath. Standard PU version for dry areas
2	05.BM.102-2		DREHFIT <u>comfort version</u> , polyether-based or anti-static (for additional charge)
3	05.BM.103		DUOFIT <u>comfort version</u> with nubs on the top and bottom for softer standing, polyether-based or anti-static (for additional charge)
4	05.BM.104		HYDROFIT black nitrile mat for wet and/or oily areas - semi-circular nubs on the top Honeycomb structure underneath - therefore only standard dimensions** are possible

Classic version: PUR integral foam mixture, mainly for dry working areas

Comfort version: Polyether-based polyurethane, water-resistant and fire retardant according to DIN 4102, part 14, B1 – for dry and damp working areas

Gluing individual mats

*The leading edges can be clipped and individual mats can be bonded/glued together.
E.g. dimensions 640 mm x 1840 mm or 640 x 2740 mm or upright glued 940 x 1840 mm or 940 x 2440 mm additional charge for gluing



** Standard dimensions are all sizes based on a multiple of 600 or 900 mm (see right)

The flex-box cabinet can be used for both heights of the metal and plastic flex-box. Flex-box cabinet see page 258

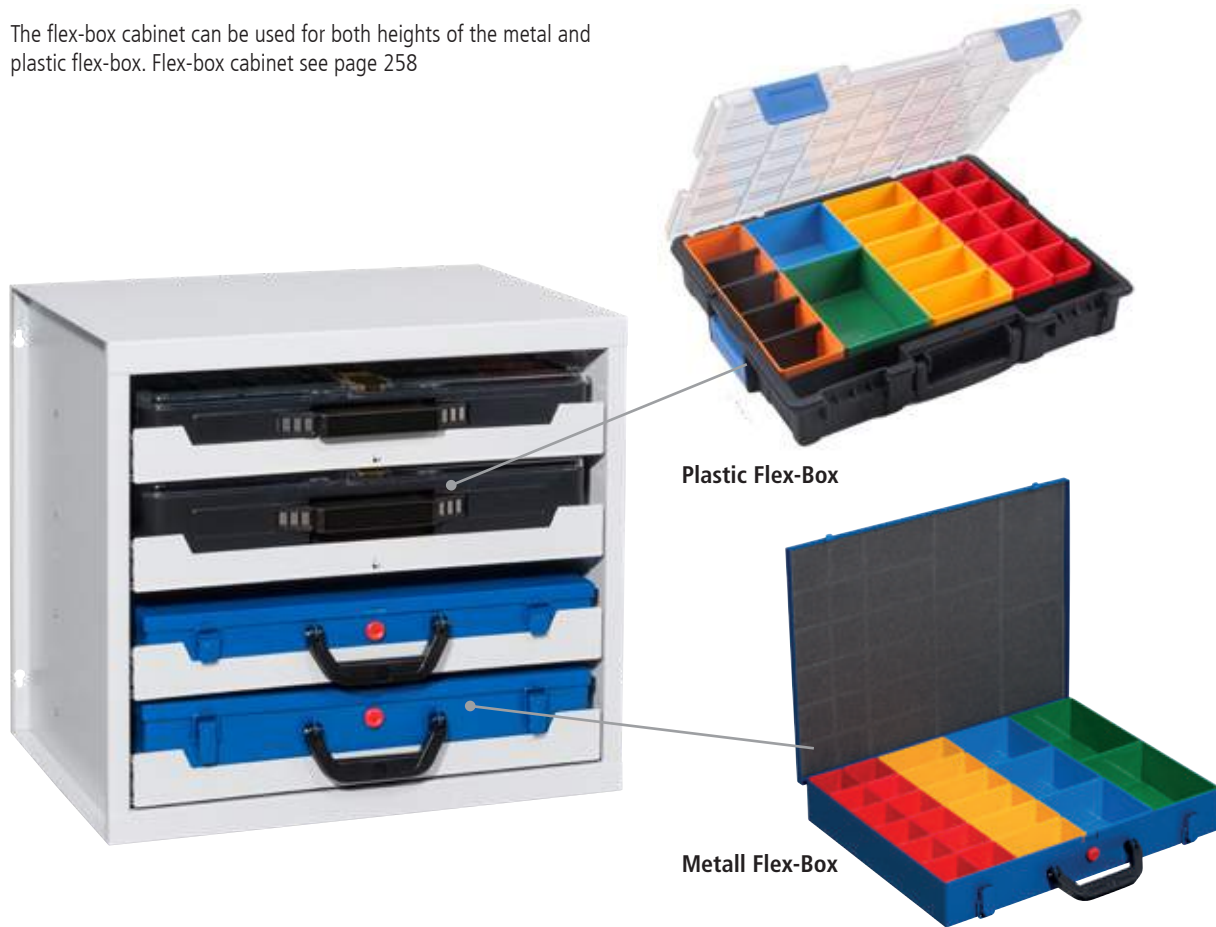

Plastic Flex-Box

Metall Flex-Box

Flex-box insert boxes

Individual subdivision for the plastic flex box and metal flex box. The insert boxes can also be used for individual arrangement in drawers, racks and cabinets.



Insert Boxes height 45 mm

Insert box	Item no..	External dimensions in mm (WxDxH)	Usable dimensions in mm (WxDxH)	Packaging unit
Size 1	03.456300.45	54 x 54 x 45	48 x 48 x 42	20 Stk.
Size 2	03.456301.45	54 x 108 x 45	48 x 101 x 42	20 Stk.
Size 3	03.456302.45	108 x 108 x 45	101 x 101 x 42	10 Stk.
Size 4	03.456303.45	108 x 162 x 45	101 x 155 x 42	10 Stk.
Size 5	03.456304.45	108 x 216 x 45	101 x 209 x 42	10 Stk.

Insert Boxes height 63 mm

Insert box	Item no..	External dimensions in mm (WxDxH)	Usable dimensions in mm (WxDxH)	Packaging unit
Size 1	03.456300.63	54 x 54 x 63	48 x 48 x 60	20 Stk.
Size 2	03.456301.63	54 x 108 x 63	48 x 101 x 60	20 Stk.
Size 3	03.456302.63	108 x 108 x 63	101 x 101 x 60	10 Stk.
Size 4	03.456303.63	108 x 162 x 63	101 x 155 x 60	10 Stk.
Size 5	03.456304.63	108 x 216 x 63	101 x 209 x 60	10 Stk.

Individual insert boxes on request

Workbench accessories UNDER THE WORKBENCH

Flex-boxes

Plastic flex-box

The polycarbonate hinged lid on a sturdy double-walled base enables the secure storage of small parts. These can be stored in insert boxes. The ergonomic, fold-down handle and the innovative locking technology make the flex-box an ideal storage space. It is available in two heights and in different fittings.



Connected boxes

Handle

New



19 compartments

- 9 x size 2
- 3 x size 3
- 4 x separators
- Transparente Einsatzboxen

Item no.	External dimensions in mm (WxDxH)	Usable dimensions in mm (WxDxH)
04.KK454223	440 x 355 x 76	405 x 320 x 60

New



12 compartments

- 1 x 283 x 60 x 42; 10 x separators

Item no.	External dimensions in mm (WxDxH)	Usable dimensions in mm (WxDxH)
04.KK454270	440 x 355 x 76	405 x 320 x 60

New



7 compartments

- 1 x 283 x 60 x 42; 4 x separators

Item no.	External dimensions in mm (WxDxH)	Usable dimensions in mm (WxDxH)
04.KK454200	440 x 355 x 76	405 x 320 x 60



15 compartments

- 3x size 2
- 6x size 3
- 1x 283 x 60 x 42; 4 separators

Item no.	External dimensions in mm (WxDxH)	Usable dimensions in mm (WxDxH)
04.KK454220	440 x 355 x 76	405 x 320 x 60



18 compartments

- 6 x size 1
- 3 x size 2
- 1 x size 3
- 1 x size 4
- 1 x size 5
- 1x 283 x 60 x 42; 4 separators

Item no.	External dimensions in mm (WxDxH)	Usable dimensions in mm (WxDxH)
04.KK454230	440 x 355 x 76	405 x 320 x 60



23 compartments

- 10x size 1
- 5x size 2
- 1x size 3
- 1x size 4
- 1x 283 x 60 x 42; 4 separators

Item no.	External dimensions in mm (WxDxH)	Usable dimensions in mm (WxDxH)
04.KK454210	440 x 355 x 76	405 x 320 x 60

New



21 compartments

- 15 x size 2
- 1 x 283 x 60 x 42; 4 x Trennsteg

Item no.	External dimensions in mm (WxDxH)	Usable dimensions in mm (WxDxH)
04.KK454240	440 x 355 x 76	405 x 320 x 60



36 compartments

- 30x size 1
- 1x 283 x 60 x 42; 4 separators

Item no.	External dimensions in mm (WxDxH)	Usable dimensions in mm (WxDxH)
04.KK454250	440 x 355 x 76	405 x 320 x 60

Metal flex-box

Sturdy, dark blue flex-box made of powder-coated sheet steel with ergonomic plastic handle for the safe and protected transportation of small parts and accessories. Foam in lid closes tightly with the inserts.



Foam in lid



Additional lid lock



23 inserts

- 12x size 1
- 6x size 2
- 3x size 3
- 2x size 4

Item no.	External dimensions in mm (WxDxH)	Usable dimensions in mm (WxDxH)
04.KK454120	440 x 370 x 70	430 x 325 x 63



12 inserts

- 12x size 3

Item no.	External dimensions in mm (WxDxH)	Usable dimensions in mm (WxDxH)
04.KK454121	440 x 370 x 70	430 x 325 x 63



24 inserts

- 24x size 2

Item no.	External dimensions in mm (WxDxH)	Usable dimensions in mm (WxDxH)
04.KK454122	440 x 370 x 70	430 x 325 x 63



48 inserts

- 48x size 1

Item no.	External dimensions in mm (WxDxH)	Usable dimensions in mm (WxDxH)
04.KK454123	440 x 370 x 70	430 x 325 x 63

Workbench accessories UNDER THE WORKBENCH

Flex-box

1 Mounting on the wall

Simple mounting on the wall with dowels and screws

2 Mounting under a workbench

Easy attachment underneath the worktop with screws

3 Freestanding

Each case cabinet stands safely on a worktop or cabinet



Rear of flex-box cabinet

Dimensions in mm

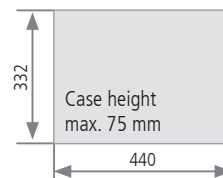
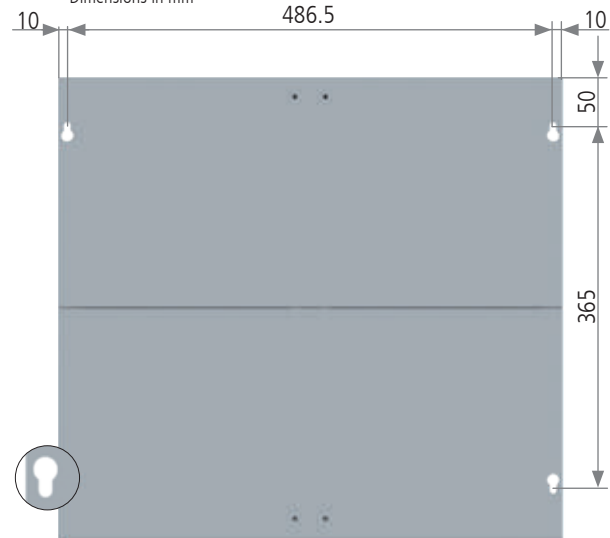

Usable dimension of pull-outs in mm



Individual drawer interlocking prevents unwanted opening



Flex-box cabinet

- With four pull-outs
- Empty
- Can be used for both heights of the metal and plastic flex-box



Worktable with flex-box cabinet

- Beech multiplex worktop 40 mm
- Table frame 40 x 40 x 2 mm, bolted
- 1x rear wall, 1x half shelf
- 1x case cabinet with 4 compartments
- Without small parts case

Item no.	External dimensions in mm (WxDxH)
07.5037	507 x 378 x 446

Item no.	External dimensions in mm (WxDxH)
03.14.30KS	1500 x 750 x 859

- Drawers with full pull-out (FP) 100%
- Load capacity 35 kg

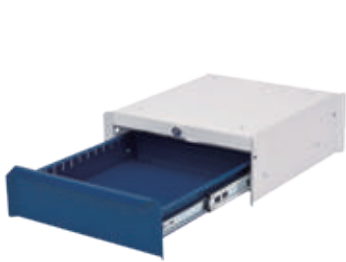

- 1x drawer, 100 mm
- Usable dimension 300 x 350 x 80 mm

Item no.	Dimensions in mm (WxDxH)
07.18.01	365 x 400 x 140



- 2x drawer, 100 mm
- 1x drawer, 200 mm

Item no.	Dimensions in mm (WxDxH)
07.18.03	365 x 400 x 500



- 4x drawer, 100 mm

Item no.	Dimensions in mm (WxDxH)
07.18.04	365 x 400 x 500



- 1x hinged door

Item no.	Dimensions in mm (WxDxH)
07.2021	300 x 600 x 600 left
07.2022	300 x 600 x 600 right



- 1x drawer, 120 mm
- 1x hinged door left or right

Item no.	Dimensions in mm (WxDxH)
07.2016	300 x 600 x 600 left
07.2017	300 x 600 x 600 right



- 4x drawer, 3x 120 mm, 1x 180 mm

Item no.	Dimensions in mm (WxDxH)
07.2018	300 x 600 x 600



- 1x hinged door
- 1x 4x socket bar
- 1x cable outlet box

Item no.	Dimensions in mm (WxDxH)
07.2019	300 x 600 x 600 left
07.2020	300 x 600 x 600 right



Hanging drawer

- Load capacity 60 kg
- Lockable
- Mounting on the worktop

Item no.	Dimensions in mm (WxDxH)	FH
07.2031	476 x 600 x 130	130
07.2032	476 x 600 x 108	180



Keyboard tray

- Support surface: 500 x 300 mm (WxD)

Item no.	Dimensions in mm (WxDxH)
07.2036	600 x 300 x 70

Workbench accessories UNDER THE WORKBENCH

Hanging base cabinets depth 500 for screw mounting directly under tabletop

- Drawers with full pull-out (FP) 100%
- Load capacity 50 kg
- Ball bearing guides

Suitable divider material can be found on page 51



Hanging base cabinet R 12-16/R 18-16

- Empty housing

Item no.	Dimensions in mm (WxDxH)	Nutzhöhe in mm
01.032	381 x 500 x 215	150
01.033	381 x 500 x 365	300
01.034	381 x 500 x 465	400
01.052	531 x 500 x 215	150
01.053	531 x 500 x 365	300
01.054	531 x 500 x 465	400

Drawer R 12-16/R18-16

- All specifications are usable dimensions

Item no.	Dimensions in mm (WxDxH)
60.038.075VA	300 x 400 x 60
60.038.100VA	300 x 400 x 90
60.038.150VA	300 x 400 x 140
60.046.075VA	450 x 400 x 60
60.046.100VA	450 x 400 x 90
60.046.150VA	450 x 400 x 140
60.046.200VA	450 x 400 x 190



- 1x hinged door, 350 mm

Item no.	Dimensions in mm (WxDxH)
44.001	531 x 500 x 465



- 1x drawer, 150 mm

Item no.	Dimensions in mm (WxDxH)
38.150	381 x 500 x 215
53.150	531 x 500 x 215



- 2x drawer, 200 mm

Item no.	Dimensions in mm (WxDxH)
38.011	381 x 500 x 465
44.011	531 x 500 x 465



- 3x drawer, 100 mm

Item no.	Dimensions in mm (WxDxH)
38.300	381 x 500 x 365
53.300	531 x 500 x 365



- 4x drawer, 100 mm

Item no.	Dimensions in mm (WxDxH)
38.020	381 x 500 x 465
53.020	531 x 500 x 465



- Drawers with full pull-out (FP) 100%
- Drawers with 50 mm front height, load capacity 70 kg
- Drawers from 75 mm front height, load capacity 100 kg
- Ball bearing guides

Suitable divider material can be found on page 75



Hanging base cabinet R 18-24

- Empty housing

Item no.	Dimensions in mm (WxDxH)	Usable height in mm
01.0520	555 x 736 x 215	150
01.0530	555 x 736 x 365	300
01.0540	555 x 736 x 465	400

Drawer R 18-24

- All specifications are usable dimensions

Item no.	Dimensions in mm (WxDxH)
60.50.050V07	450 x 600 x 30
60.50.100V10	450 x 600 x 83
60.50.150V10	450 x 600 x 133
60.50.200V10	450 x 600 x 183



- 1x drawer, 150 mm

Item no.	Dimensions in mm (WxDxH)
520/1VA-1	555 x 736 x 215

- 3x drawer, 1x 50 mm, 1x 100 mm, 1x 150 mm

Item no.	Dimensions in mm (WxDxH)
530.111V	555 x 736 x 365

- 3x drawer, 100 mm

Item no.	Dimensions in mm (WxDxH)
535/300V	555 x 736 x 365



- 4x drawer, 100 mm

Item no.	Dimensions in mm (WxDxH)
535/020V	555 x 736 x 465

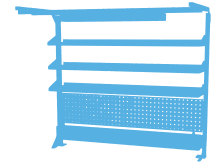

Multi-board setup





Multi-board setup

Page 265



Energy duct

Page 279



Multi-board accessories

Page 284



Lighting

Page 296



Perforated walls and accessories

Page 307



Workbenches with multi-board setup

MULTI-WALL – suitable for all workstations



Our features	Your advantages
Suitable for all workstations	Custom arrangement options
Modular system	Combinations in different dimensions freely configurable
Two different fastening systems	Suitable for all worktop designs and thicknesses
Perforated and slotted profiles – reinforced and welded	Very stable construction, which the various accessories or special solutions can be attached to
Heights: 650, 950, 1250 & 1550 mm Widths: 700, 1000, 1500 & 2000 mm	Individuality and arrangement can be implemented completely according to customer requirements
Wide range of accessories	The right solution for every application
Attachment of overhead frames with equipment rails possible	Lighting and slider mounted extremely easily, providing ergonomic working conditions
Electricity and compressed air supplied via energy ducts	Power supplied directly at the workplace
Convertible and retrofittable at any time	Additional parts can attached and existing parts can be converted for modified working conditions
All parts available in 15 standard colours	Eco-friendly painting procedure

- Delivered unassembled, for easy self-assembly

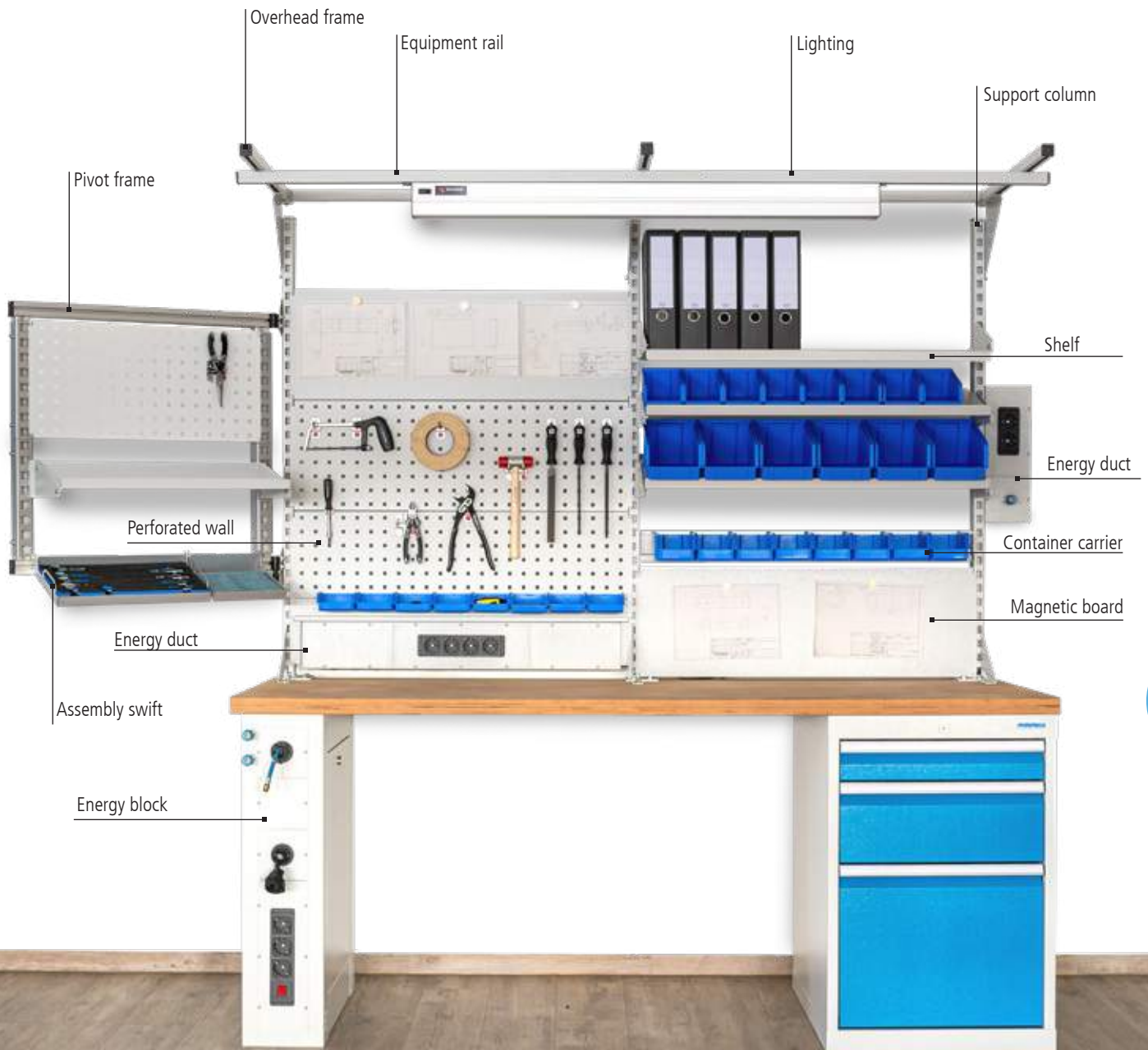

Workbenches with multi-board setup

Grid: R 12-14 R 24-12 R 24-16 R 12-16 R 18-16 R 24-16 R 36-16 **R 18-24 R 24-24** R 36-24 R 48-24

- Full pull-out 100 %, load capacity 100 kg
- Supplied without decoration

Suitable divider material for the R 18-24 and R 24-24 can be found on page 75 and 83



Multi-board setup

- 2x support column, 650 mm
- 2x shelf, 320 mm

Item no.	Dimensions in mm (WxH)
03.900.15.33	1500 x 650

Box workbench R 18-24

- Beech multiplex worktop, 1500 x 750 x 40 mm
- Left: 3x drawer | Right: 3x drawer

Item no.	Dimensions in mm (WxDxH)
03.14.33V	1500 x 750 x 859



Multi-board setup

- 2x support column, 650 mm
- 1x perforated wall
- 1x shelf, 320 mm

Item no.	Dimensions in mm (WxH)
03.900.15.02-01	1500 x 650

Box workbench R 24-24

- Beech multiplex worktop 40 mm
- Left: 2x shelf | Right: 1x drawer, 1x hinged door

Item no.	Dimensions in mm (WxDxH)
03.15.37V	1500 x 750 x 859

- Full pull-out 100 %, load capacity 100 kg
- Supplied without decoration



Suitable divider material for the R 18-24 can be found on page 75

Multi-board setup

- 2x support column, 1250 mm
- 2x magnetic board
- 2x perforated wall, 1500 mm
- 3x shelf, 320 mm

Item no.	Dimensions in mm (WxH)
03.900.15.580.4	1500 x 1250

Inline workbench R 18-24

- Beech multiplex worktop, 1500 x 750 x 40 mm
- 4x drawer
- Base frame made of 50 x 50 x 2 mm square tube

Item no.	Dimensions in mm (WxDxH)
03.15.580.4V	1500 x 750 x 859



Multi-board setup

- 3x support column, 1250 mm
- 1x energy bar with 3x earthed sockets and on/off switch
- 1x perforated wall, 1000 mm
- 2x shelf, 320 mm
- 1x multi roller shutter cabinet 910 x 210 x 820 mm
- 1x overhead frame
- 1x equipment rail
- 1 x LED lighting 37,8 W, 1226 lx

Item no.	Dimensions in mm (WxH)
03.900.21	2000 x 1250

Inline workbench R 18-24

- Beech multiplex worktop, 2000 x 750 x 40 mm
- 4x drawer
- Base frame made of 50 x 50 x 2 mm square tube

Item no.	Dimensions in mm (WxDxH)
03.20.580.4V	2000 x 750 x 859

Workbenches with multi-board setup

Grid: R 12-14 R 24-12 R 24-16 R 12-16 R 18-16 R 24-16 R 36-16 **R 18-24 R 24-24** R 36-24 R 48-24

- Full pull-out 100 %, load capacity 100 kg
- Supplied without decoration



Multi-board setup

- 2x support column 1250 mm
- 1x energy bar with 3x earthed socket and on/off switch
- 1x perforated wall
- 1x magnetic board
- 2x shelf, 320 mm
- 1x overhead frame
- 2x equipment rail
- 1x LED lighting 28,9 W, 1290 lx
- 1x slider

Item no.	Dimensions in mm (WxDxH)
03.900.14.16	1500 x 750 x 1250

Box workbench R 18-24

- Beech multiplex worktop, 1500 x 750 x 40 mm
- Left: Steel shelf, half depth | Right: 4x drawer

Item no.	Dimensions in mm (WxDxH)
03.14.16V	1500 x 750 x 859



Multi-board setup

- 3x support column 1250 mm
- 2x energy bar with 3x earthed socket and on/off switch
- 2x perforated wall
- 2x magnetic board
- 2x rail for open fronted storage bins, length 450 mm
- 2x pivot arm support
- 1x pivot arm with shelf
- 1x pivot arm with monitor bracket and keyboard platform
- 3x shelf, 320 mm
- 1x overhead frame
- 2x equipment rail
- 2x LED lighting 28,9 W, 1290 lx

Item no.	Dimensions in mm (WxDxH)
03.900.20.16	2000 x 750 x 1250

Box workbench R 24-24

- Beech multiplex worktop, 2000 x 750 x 40 mm
- Left: 1x hinged door, 1x shelf | Centre: 2x shelf
- Right: 4x drawer

Item no.	Dimensions in mm (WxDxH)
03.20.16V	2000 x 750 x 859

- Full pull-out 100 %, load capacity 100 kg
- Supplied without decoration

Suitable divider material for the R 18-24 can be found on page 75



Multi-board setup

- 3x support column 1250 mm
- 2x energy bar with 3x earthed sockets and on/off switch
- 2x perforated wall
- 4x shelf, 320 mm
- 1x overhead frame
- 1x equipment rail
- 1 x LED lighting 37,8 W, 1226 lx

Item no.	Dimensions in mm (WxDxH)
03.900.22	2000 x 750 x 1250

Box workbench R 18-24

- Beech multiplex worktop, 2000 x 750 x 40 mm
- Left: 1x drawer, 1x hinged door | Centre: 3x drawer
- Right: 1x drawer, 1x hinged door

Item no.	Dimensions in mm (WxDxH)
03.19.37V	2000 x 750 x 859



Multi-board setup

- 3x support column 1250 mm
- 1x energy bar with 3x earthed sockets and on/off switch
- 2x perforated wall
- 2x magnetic board
- 2x rail for open fronted storage bins, length 450 mm
- 2x shelf, 320 mm
- 1x overhead frame
- 1x equipment rail
- 1x LED lighting 37,8 W, 1226 lx
- 1x Pivot arm with shelf and ribbed rubber mat

Item no.	Dimensions in mm (WxDxH)
03.900.23	2000 x 750 x 1250

Box workbench R 18-24

- Beech multiplex worktop, 2000 x 750 x 40 mm
- Left: 4x drawer | Center: 3x drawer | Right: 4x drawer

Item no.	Dimensions in mm (WxDxH)
03.19.38V	2000 x 750 x 859

Workbenches with multi-board setup

Grid: R 12-14 R 24-12 R 24-16 R 12-16 **R 18-16** R 24-16 R 36-16 R 18-24 R 24-24 R 36-24 R 48-24

- Stable square tube frame 40 x 40 x 2 mm
- For assembly, workshop and shipping
- Completely welded and screwed
incl. stiffening plate and leveling feet
- Worktops on/from page 422



Multi-board setup

- 2x support column
- 1x energy bar with 3x earthed sockets and on/off switch
- 1x perforated wall, 1x shelf, 320 mm
- 1x pivot arm support
- 1x pivot arm with monitor bracket and keyboard platform
- 1x overhead frame, 1x equipment rail
- 1x LED lighting 28,9 W, 1290 lx

Item no.	Dimensions in mm (WxDxH)
03.900.15.14	1500 x 750 x 1250

Worktable/bench R 18-24

- Beech multiplex worktop, 1500 x 750 x 40 mm
- Full pull-out 100 %, load capacity 100 kg
- Incl. hanging drawer 150 mm



Item no.	Dimensions in mm (WxDxH)
03.14.520V	1500 x 750 x 859

Mobile drawer cabinet R 18-16

- Including raised edges and ribbed rubber mat
- 4x steering caster, Ø 125 mm, thereof 2 with locks
- 3x drawer, 100 mm
- 1x drawer, 200 mm
- Full pull-out 100%, load capacity 50 kg
- Individual pull-out lock

Item no.	Dimensions in mm (WxDxH)
46.301M	530 x 500 x 805

Lateral PC support

Item no.	Dimensions in mm (WxDxH)
07.00.19	225 x 500 x 80



- Full pull-out 100 %, load capacity 100 kg
- Supplied without decoration

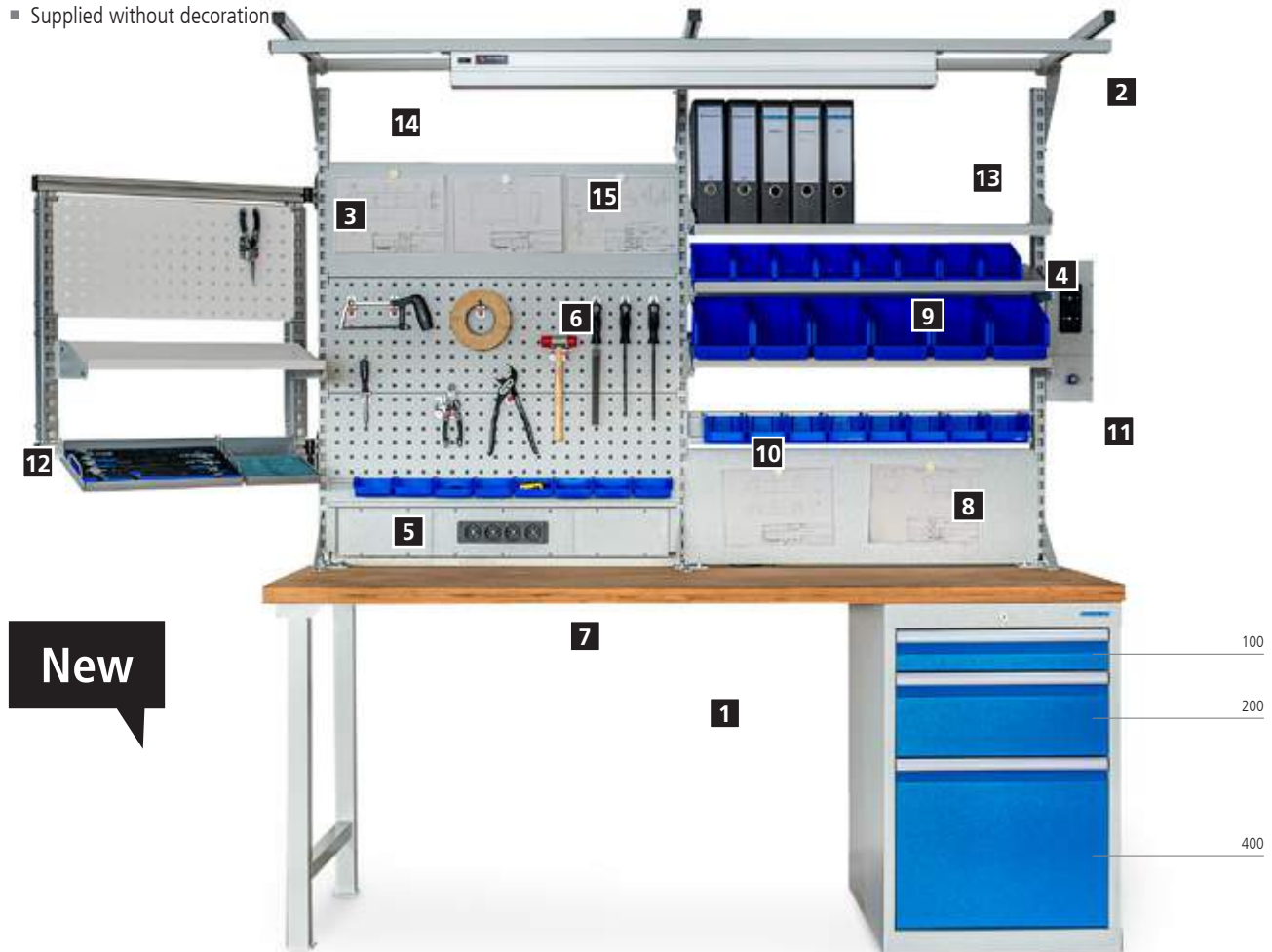

New

	Item no.	Dimensions in mm (WxDxH)	Description
1	03.20.580.3V	2000 x 750 x 859	Inline workbench with drawer cabinet R 18-24, 3 drawers Worktop beech multiplex 2000 x 750 x 40 mm Stable square tube frame 50 x 50 x 2 mm
2	03.900.20.27		Multi-board setup as shown, 3 x support column, 1 x overhead frame, 1 x equipment rail, 1 x lighting 37,8W-1226 lx, 2 x perforated wall, 2 magnetic board, 1 x energy duct with 4 x earthed sockets, 1 x energy duct with 2 earthed sockets and 1 compressed air connection 1/4", 2 x shelf 320 mm, 1 x shelf 220 mm tief, 1 x container carrier with 8 open fronted storage bins 100x170x80 mm, 2 x rail for open fronted storage bins 450 mm, 1 x pivot arm with perforated wall, shelf and 2 x assembly swift
3	03.935.125.240		Support column left + center 1250 mm height
4	03.935.125.140		Support column right 1250 mm height
5	03.983.102	1000 x 20 x 302	Perforated wall 1000 mm, 10 x 10 mm grid
6	03.983.10	1000 x 20 x 302	Magnetic board 1000 mm
7	07.861.10.09		Energy duct 1000 mm, 4 earthed socket
8	03.900.012		Container carrier 1000 mm, incl. 8x open fronted storage bins 100 x 170/140 x 80 mm
9	03.910.220	1000 x 220 x 20	Shelf 1000 mm tiltable 0,10,20°, 220 mm depth
10	03.910.320	1000 x 320 x 20	Shelf 1000 mm tiltable 0,10,20°, 320 mm depth
11	07.861.375.1		Energy duct 375 mm 2x earthed socket, 1x compress air connector
12	07.98.7074	700 x 700 x 40	Pivot arm with 1 x perforated wall 1 x shelf 220 mm depth, tiltable, 4 x adapter bar, 2 x assembly swift 200 x 200 x 25 mm
13	07.8920.1	2000 x 750	Overhead frame
14	03.920.03	2000 x 30 x 30	Equipment rail
15	03L12M50B	1154 x 70 x 80	LED lighting 1200 mm, 37,8 W, 1226 lx, 3822 lm

Workbenches with multi-board setup

Multi-board setup 1500 mm



- 2x support column, 1x overhead frame, 1x equipment rail
- 1x LED lighting 28,9 W, 1290 lx
- 1x energy bar with 3x earthed sockets and on/off switch
- 2x 1/4" compressed air connection, 2x shelf, 320 mm
- 1x perforated wall, 1x pivot arm with platform

Item no.	Dimensions in mm (WxDxH)	Version
03.900.15.24	1500 x 750 x 1250	Multi-board
03.900.15.24-1	1500 x 1250	Without overhead frame and lighting



- 2x support column, 1x overhead frame, 1x equipment rail
- 1x LED lighting 28,9 W, 1290 lx
- 1x energy bar with 3x earthed sockets and on/off switch
- 3x shelf, 320 mm, 1x perforated wall

Item no.	Dimensions in mm (WxDxH)	Version
03.900.15.25	1500 x 750 x 1250	Multi-board
03.900.15.25-1	1500 x 1250	Without overhead frame and lighting



- 2x support column, 1x overhead frame, 1x equipment rail
- 1x LED lighting 28,9 W, 1290 lx
- 1x energy bar with 3x earthed sockets and on/off switch
- 2x 1/4" compressed air connection, 2x shelf, 320 mm

Item no.	Dimensions in mm (WxDxH)	Version
03.900.15.23	1500 x 750 x 1250	Multi-board
03.900.15.23-1	1500 x 1250	Without overhead frame and lighting



- 2x support column, 1x overhead frame, 1x equipment rail
- 1x LED lighting 28,9 W, 1290 lx
- 1x energy bar with 3x earthed sockets and on/off switch
- 2x 1/4" compressed air connection, 1x shelf, 320 mm
- 1x perforated wall, 1x magnetic board, 1x pivot arm with platform

Item no.	Dimensions in mm (WxDxH)	Version
03.900.15.21	1500 x 750 x 1250	Multi-board
03.900.15.21-1	1500 x 1250	Without overhead frame and lighting



- 2x support column, 1x overhead frame, 1x equipment rail
- 1x LED lighting 28,9 W, 1290 lx
- 1x energy bar with 3x earthed sockets and on/off switch
- 4x shelf, 320 mm

Item no.	Dimensions in mm (WxDxH)	Version
03.900.15.22	1500 x 750 x 1250	Multi-board
03.900.15.22-1	1500 x 1250	Without overhead frame and lighting



- 2x support column, 1x overhead frame, 1x equipment rail
- 1x LED lighting 28,9 W, 1290 lx
- 1x energy bar with 3x earthed sockets and on/off switch
- 2x 1/4" compressed air connection, 1x shelf, 320 mm
- 1x perforated wall, 1x magnetic board

Item no.	Dimensions in mm (WxDxH)	Version
03.900.15.20	1500 x 750 x 1250	Multi-board
03.900.15.20-1	1500 x 1250	Without overhead frame and lighting

Multi-board setup 2000 mm

Multi-board setup



- 3x support column, 1x overhead frame, 1x equipment rail
- 1x LED lighting 37,8 W, 1226 lx
- 1x energy bar with 3x earthed sockets and on/off switch
- 2x 1/4" compressed air connection, 4x shelf, 320 mm
- 2x perforated wall, 1x pivot arm with platform

Item no.	Dimensions in mm (WxDxH)	Version
03.900.20.24	2000 x 750 x 1250	Multi-board
03.900.20.24-1	2000 x 1250	Without overhead frame and lighting



- 3x support column, 1x overhead frame, 1x equipment rail
- 1x LED lighting 37,8 W, 1226 lx
- 1x energy bar with 3x earthed sockets and on/off switch
- 6x shelf, 320 mm, 2x perforated wall

Item no.	Dimensions in mm (WxDxH)	Version
03.900.20.26	2000 x 750 x 1250	Multi-board
03.900.20.26-1	2000 x 1250	Without overhead frame and lighting



- 3x support column, 1x overhead frame, 1x equipment rail
- 1x LED lighting 37,8 W, 1226 lx
- 1x energy bar with 3x earthed sockets and on/off switch
- 2x 1/4" compressed air connection, 4x shelf, 320 mm

Item no.	Dimensions in mm (WxDxH)	Version
03.900.20.23	2000 x 750 x 1250	Multi-board
03.900.20.23-1	2000 x 1250	Without overhead frame and lighting



- 3x support column, 1x overhead frame, 1x equipment rail
- 1x LED lighting 37,8 W, 1226 lx
- 1x energy bar with 3x earthed sockets and on/off switch
- 2x 1/4" compressed air connection, 2x shelf, 320 mm
- 2x perforated wall, 2x magnetic board, 1x pivot arm with platform

Item no.	Dimensions in mm (WxDxH)	Version
03.900.20.21	2000 x 750 x 1250	Multi-board
03.900.20.21-1	2000 x 1250	Without overhead frame and lighting



- 3x support column, 1x overhead frame, 1x equipment rail
- 1x LED lighting 37,8 W, 1226 lx
- 1x energy bar with 3x earthed sockets and on/off switch
- 8x shelf, 320 mm

Item no.	Dimensions in mm (WxDxH)	Version
03.900.20.22	2000 x 750 x 1250	Multi-board
03.900.20.22-1	2000 x 1250	Without overhead frame and lighting



- 3x support column, 1x overhead frame, 1x equipment rail
- 1x LED lighting 37,8 W, 1226 lx
- 1x energy bar with 3x earthed sockets and on/off switch
- 2x 1/4" compressed air connection, 2x shelf, 320 mm
- 2x perforated wall, 2x magnetic board

Item no.	Dimensions in mm (WxDxH)	Version
03.900.20.20	2000 x 750 x 1250	Multi-board
03.900.20.20-1	2000 x 1250	Without overhead frame and lighting

Multi-board

Support columns

Multi-board setup



Suitable for mounting on worktops from 40 mm



Support column profile 30 x 60 mm

- Reinforced by U-profile tube
- Thinner plate thicknesses on request

Item no.	Dimensions in mm
03.935.650.240	650 left
03.935.650.140	650 right
03.935.950.240	950 left
03.935.950.140	950 right
03.935.125.240	1250 left
03.935.125.140	1250 right
03.935.155.240	1550 left
03.935.155.140	1550 right



Helm-rail galvanized

Item no.	Dimension in mm (WxDxH)
03.HELM100	1000 x 30 x 30
03.HELM125	1250 x 30 x 30
03.HELM150	1500 x 30 x 30
03.HELM175	1750 x 30 x 30
03.HELM200	2000 x 30 x 30



Runner

Item no.
03.HEMLAUFW



Stopper For runner

Item no.
03.HELMSTO



Spring balancer with hose



Spring balancer

Spring balancer with hose

- Max. 8 bar, air flow rate 370 l/min, both sides 1/4"
- 1400 mm pull-out

Item no.	Weight in kg
03.900.60	0,4 - 0,8
03.900.61	0,8 - 1,5
03.900.62	1,2 - 2,5

Spring balancer

- 1600 mm pull-out

Item no.	Weight in kg
03.900.44	0,4 - 1,0
03.900.45	1,0 - 2,0
03.900.46	2,0 - 3,0



Overhead frame with bolted reinforcement cross-members

Item no.	WxD in mm
07.8910.1	1000 x 750
07.8912.1	1250 x 750
07.8915.1	1500 x 750
07.8917.1	1750 x 750
07.8920.1D	2000 x 750

*Overhead frames with a width of 2000 mm may sag slightly under higher loads

Overhead frame with bolted reinforcement cross-members

Item no.	WxD in mm
07.8920.1	2000 x 750



Double-sided overhead frame with bolted reinforcement cross-members

Item no.	Dimensions in mm (WxDxH)
07.8910.2	1000 x 750
07.8915.2	1500 x 750
07.8920.2D*	2000 x 750

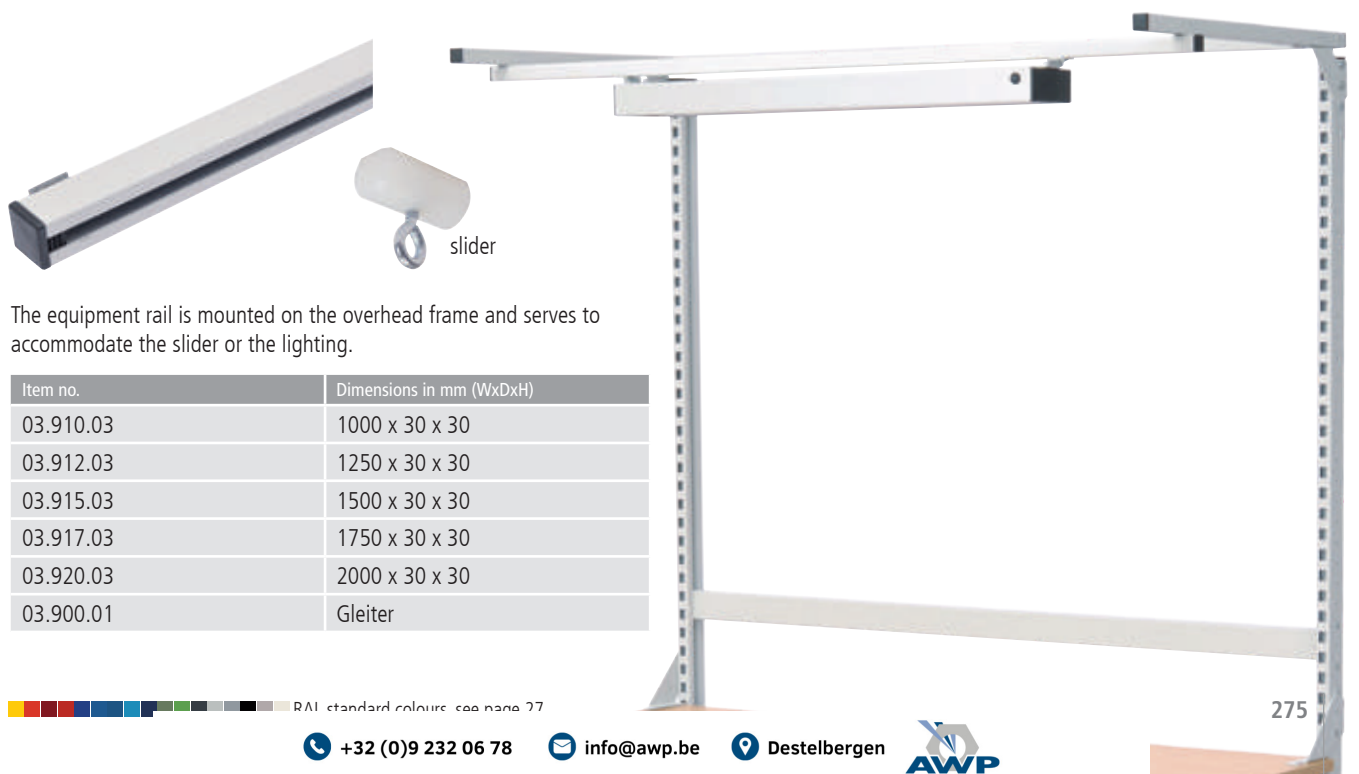

The equipment rail is mounted on the overhead frame and serves to accommodate the slider or the lighting.

Item no.	Dimensions in mm (WxDxH)
03.910.03	1000 x 30 x 30
03.912.03	1250 x 30 x 30
03.915.03	1500 x 30 x 30
03.917.03	1750 x 30 x 30
03.920.03	2000 x 30 x 30
03.900.01	Gleiter

Multi-board

Multi-board setup for panel thicknesses from 40 mm

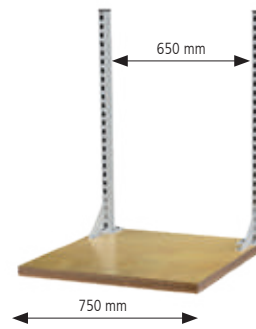
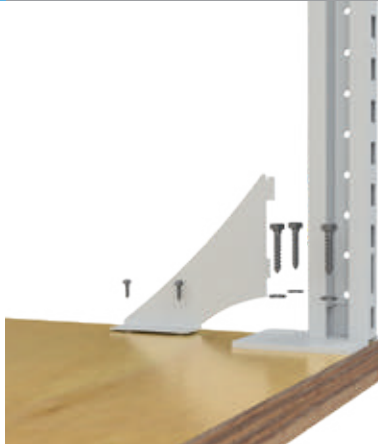

- Table width 750 mm
- Superstructure width centre-centre 650 mm
- 1x support column left
- 1x support column right

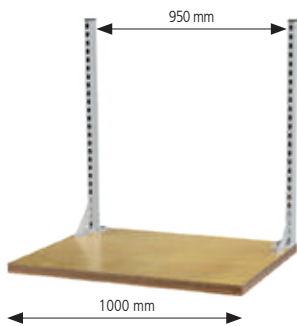

- Table width 1000 mm
- Superstructure width centre-centre 950 mm
- 1x support column left
- 1x support column right

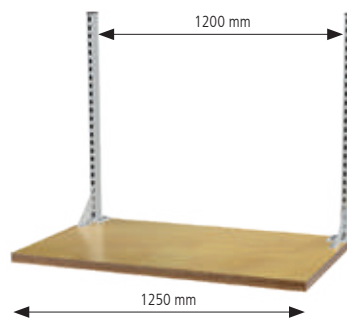

- Table width 1250 mm
- Superstructure width centre-centre 1200 mm
- 1x support column left
- 1x support column right

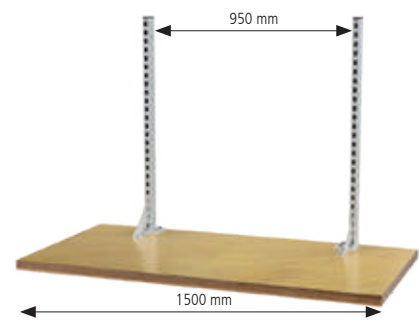

- Table width 1500 mm
- Superstructure width centre-centre 950 mm
- 1x support column left
- 1x support column right

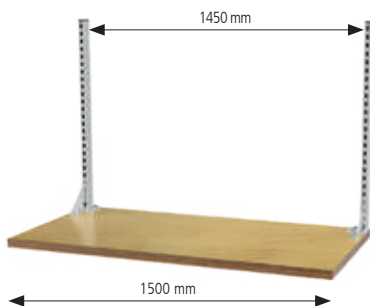

- Table width 1500 mm
- Superstructure width centre-centre 1450 mm
- 1x support column left
- 1x support column right

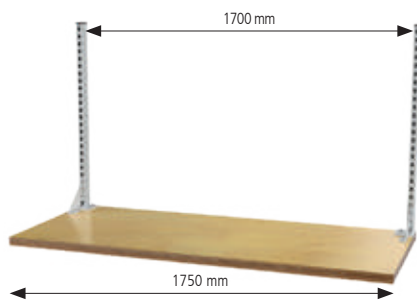

- Table width 1750 mm
- Superstructure width centre-centre 1700 mm
- 1x support column left
- 1x support column right

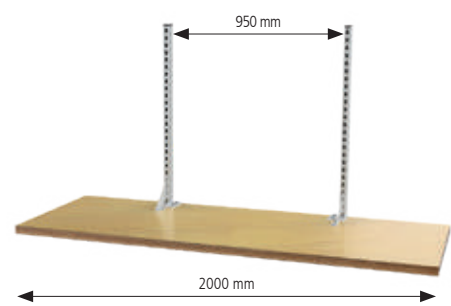

- Table width 2000 mm
- Superstructure width centre-centre 950 mm
- 1x support column left
- 1x support column right

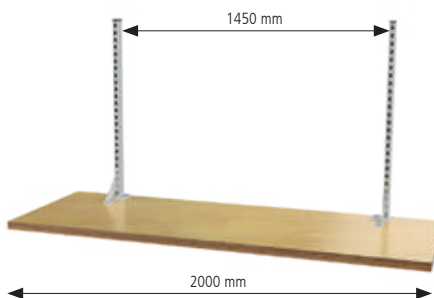

- Table width 2000 mm
- Superstructure width centre-centre 1450 mm
- 1x support column left
- 1x support column right

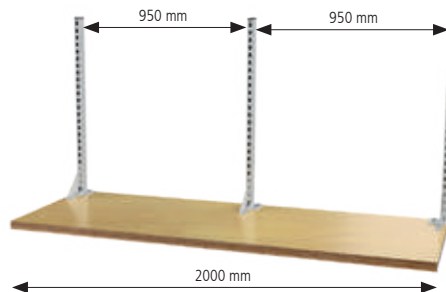

- Table width 2000 mm
- Superstructure width centre-centre 2 x 950 mm
- 2x support column left
- 1x support column right

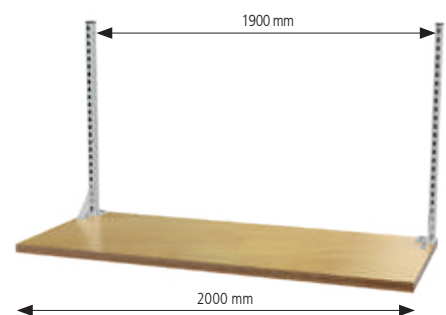

- Table width 2000 mm
- Superstructure width centre-centre 1900 mm
- 1x support column left
- 1x support column right



Open fronted storage bins

- Made of polypropylene (lids on request)

Item no.	Dimensions in mm (WxDxH)
03.900.001	100 x 95 / 65 x 50
03.900.002	100 x 175 / 140 x 75
03.900.003	145 x 235 / 195 x 125



Rail for open fronted storage bins on perforated wall

Item no.	Length in mm
03.900.06	300
03.900.05	450

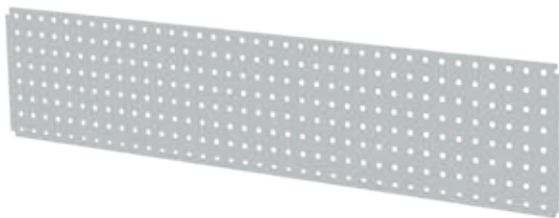

Perforated wall

- 2000 mm perforated walls can only be attached to setups with 2 support columns, otherwise 2 x 1000 mm are required

Item no.	Dimensions in mm (WxDxH)
03.983.101	700 x 20 x 302
03.983.102	1000 x 20 x 302
03.983.104	1250 x 20 x 302
03.983.103	1500 x 20 x 302
03.983.106	1750 x 20 x 302
03.983.105	2000 x 20 x 302



Magnetic board

- 2000 mm magnetic boards can only be attached to setups with 2 support columns, otherwise 2 x 1000 mm are required

Item no.	Dimensions in mm (WxDxH)
03.983.07	700 x 20 x 302
03.983.10	1000 x 20 x 302
03.983.12	1250 x 20 x 302
03.983.15	1500 x 20 x 302
03.983.17	1750 x 20 x 302
03.983.20	2000 x 20 x 302

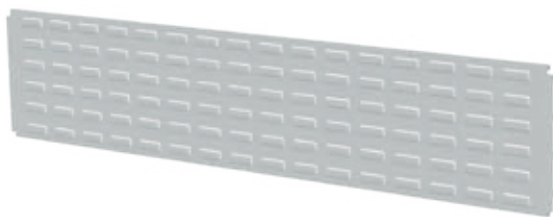

Slotted wall

- 2000 mm slotted walls can only be attached to setups with 2 support columns, otherwise 2 x 1000 mm are required

Item no.	Dimensions in mm (WxDxH)
03.983.111	700 x 20 x 302
03.983.112	1000 x 20 x 302
03.983.114	1250 x 20 x 302
03.983.113	1500 x 20 x 302
03.983.116	1750 x 20 x 302
03.983.115	2000 x 20 x 302



Monitor holder incl. crossbar

- 2000 mm crossbars can only be attached to setups with 2 support columns, otherwise 2 x 1000 mm are required

Item no.	Dimensions in mm (WxDxH)
03MONTRA070	700 x 125 x 121
03MONTRA100	1000 x 125 x 121
03MONTRA125	1250 x 125 x 121
03MONTRA150	1500 x 125 x 121
03MONTRA175	1750 x 125 x 121
03MONTRA200	2000 x 125 x 121

Monitor holder

Item no.	Dimensions in mm (WxDxH)
03MONHAL	125 x 125 x 121

Multi-board

Energy duct accessories

Shelf for hanging between the support columns

- Adjustable height and incline
- Inclination 0°, 10° and 20° incl. roll-off edge
- 2000 mm shelves can only be attached to setups with 2 support columns, otherwise 2 x 1000 mm are required
- Includes bracket
- Load capacity refers to uniformly distributed load



Shelf 700 mm



Item no.	Dimensions in mm (WxDxH)	Usable dimensions in mm (WxD)
03.907.220	700 x 220 x 20	614 x 218
03.907.320	700 x 320 x 20	614 x 318
03.907.420	700 x 420 x 20	614 x 418

Shelf 1000 mm



Item no.	Dimensions in mm (WxDxH)	Usable dimensions in mm (WxD)
03.910.220	1000 x 220 x 20	914 x 218
03.910.320	1000 x 320 x 20	914 x 318
03.910.420	1000 x 420 x 20	914 x 418

Shelf 1250 mm



Item no.	Dimensions in mm (WxDxH)	Usable dimensions in mm (WxD)
03.912.220	1250 x 220 x 20	1164 x 218
03.912.320	1250 x 320 x 20	1164 x 318
03.912.420	1250 x 420 x 20	1164 x 418

Shelf 1500 mm



Item no.	Dimensions in mm (WxDxH)	Usable dimension in mm (WxD)
03.915.220	1500 x 220 x 20	1414 x 218
03.915.320	1500 x 320 x 20	1414 x 318
03.915.420	1500 x 420 x 20	1414 x 418

Shelf 1750 mm



Item no.	Dimensions in mm (WxDxH)	Usable dimension in mm (WxD)
03.917.220	1750 x 220 x 20	1664 x 218
03.917.320	1750 x 320 x 20	1664 x 318
03.917.420	1750 x 420 x 20	1664 x 418

Shelf 2000 mm



Item no.	Dimensions in mm (WxDxH)	Usable dimension in mm (WxD)
03.920.220	2000 x 220 x 20	1864 x 218
03.920.320	2000 x 320 x 20	1864 x 318
03.920.420	2000 x 420 x 20	1864 x 418



Wooden shelf

- For mounting between the support columns

Item no.	Dimensions in mm (WxDxH)
07.8907.350	700 x 350 x 19
07.8910.350	1000 x 350 x 19
07.8912.350	1250 x 350 x 19
07.8915.350	1500 x 350 x 19

Fitting carried out completely according to customer requirements, the individual components can be screwed on individually. The energy duct is available in three different lengths. Special brackets offer attachment options between or in front of the support columns or on the overhead frame of the multi-board setup. Attachment directly to the worktop is also possible.



Direct supply of electricity and compressed air via the energy duct. Each component is earthed separately. The individual elements in the energy duct are supplied via M20 cable glands.

For the energy bars offered here, on-site fuse protection is assumed.

Energy duct mounting bracket see page 281



Energy duct

- Energy duct, fully equipped with 1x socket bar with 3x earthed socket with on/off switch
- Unwired

Item no.	Dimensions in mm (WxDxH)	Systemmaß in mm
07.861.10.10	875 x 60 x 130	1000
07.861.15.10	1375 x 60 x 130	1500
07.861.20.10	1875 x 60 x 130	2000

Energy duct

- Energy duct, fully equipped with 1x socket bar with 3x earthed socket with on/off switch
- 2x 1/4" compressed air connection
- Unwired

Item no.	Dimensions in mm (WxDxH)	Systemmaß in mm
07.861.10.11	875 x 60 x 130	1000
07.861.15.11	1375 x 60 x 130	1500
07.861.20.11	1875 x 60 x 130	2000



Energy duct

- Energy duct, fully equipped with 1x socket bar with 3x earthed socket with on/off switch
- 2x 1/4" compressed air connection
- 1x CEE socket 16 A, unwired

Item no.	Dimensions in mm (WxDxH)	Systemmaß in mm
07.861.10.12	875 x 60 x 130	1000
07.861.15.12	1375 x 60 x 130	1500
07.861.20.12	1875 x 60 x 130	2000

Energy duct

- Energy duct, fully equipped with 2x Schuko-Steckdose mit Deckel
- 1x 1/4" compressed air connection
- 1x CEE socket 16 A
- Emergency stop button, unwired

Item no.	Dimensions in mm (WxDxH)	Systemmaß in mm
07.861.10.13	875 x 60 x 130	1000
07.861.15.13	1375 x 60 x 130	1500
07.861.20.13	1875 x 60 x 130	2000

Multi-board

Energy duct accessories



New



Energy duct, empty

- Universal applicable
- Fuses see page 283
- Unwired
- The width of the individual cover plates added together equals the width of the energy duct

Item no.	Dimensions in mm (WxDxH)	Total width in mm
07.861.501	375 x 60 x 130	-
07.861.500	500 x 60 x 130	-
07.861.701	625 x 60 x 130	750
07.861.801	875 x 60 x 130	1000
07.861.1251	1125 x 60 x 130	1250
07.861.1301	1375 x 60 x 130	1500
07.861.1751	1625 x 60 x 130	1750
07.861.1801	1875 x 60 x 130	2000

Various mounting options

- Mounting laterally on the support column
- Mounting under the worktop
- Mounting between the support columns



New



Energy duct

- 45° inclination
- For mounting on the workbench
- Fuses see page 283
- Unwired
- The width of the individual cover plates added together equals the width of the energy duct

Item no.	Dimensions in mm (WxDxH)
07.861.1005	1000 x 150 x 150
07.861.1255	1250 x 150 x 150
07.861.1505	1500 x 150 x 150
07.861.2005	2000 x 150 x 150





Energy duct mounting bracket for mounting in front of the support columns

- Mounting brackets for mounting energy duct in front of support columns (pair)

Item no.	Version in mm
07.861.03	1000 / 1500
07.861.03-1	625 / 2000



Energy duct mounting bracket for mounting on the worktop

- Mounting brackets for direct mounting on worktop (pair)

Item no.	Dimensions in mm (WxDxH)
03.861.04	60 x 52 x 110



Energy duct mounting bracket for mounting between the support columns

- Mounting brackets for mounting energy duct between support columns (pair)

Item no.	Dimensions in mm (WxDxH)
07.861.01-1	33 x 38 x 117



Cover plate and network socket

- Cover plate incl. RJ45 socket

Item no.	Dimensions in mm (WxH)
07.861.19	125 x 125



Cover plate and toggle switch

- Cover plate incl. toggle switch

Item no.	Dimensions in mm (WxH)
07.861.10	125 x 125



Cover plate and CEE socket

- Cover plate incl. CEE socket

Item no.	Dimensions in mm (WxH)
07.861.12	16 A - 250 x 125
07.861.32	32 A - 250 x 125



Cover plate and emergency stop

- Cover plate incl. emergency stop button

Item no.	Dimensions in mm (WxH)
07.861.09	125 x 125



Cover plate and earthed socket

- Cover plate incl. earthed socket

Item no.	Dimensions in mm (WxH)
07.861.11	125 x 125



Cover plate and compressed air

- Cover plate incl. compressed air connection

Item no.	Dimensions in mm (WxH)
07.861.07	1 / 4" - 125 x 125
07.861.08	1 / 2" - 125 x 125



Multi-board

Energy duct accessories

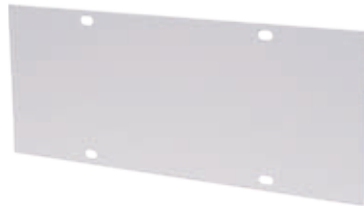

Cover plate for the energy duct

Item no.	Dimensions in mm (WxH)
07.861.04	125 x 125
07.861.05	250 x 125
07.861.06	375 x 125



Cover plate and socket panel

- Cover plate incl. socket panel with 2x earthed socket

Item no.	Dimensions in mm (WxH)
07.861.21	250 x 125



Cover plate and socket panel

- Cover plate incl. socket panel with 2x earthed socket

Item no.	Dimensions in mm (WxH)
07.861.14	375 x 125



Cover plate and socket panel

- Cover plate incl. socket panel with 3x earthed sockets with on/off switch

Item no.	Dimensions in mm (WxH)
07.861.15	375 x 125



Cover plate and socket panel

- Cover plate incl. socket panel with 4x earthed socket

Item no.	Dimensions in mm (WxH)
07.861.16	375 x 125



USB port

- Cover plate incl. earthed socket, USB A and USB C port

Item no.	Dimensions in mm (WxH)
07.861.26	125 x 125



USB port

- Cover plate incl. USB A and USB C port

Item no.	Dimensions in mm (WxH)
07.861.33	125 x 125



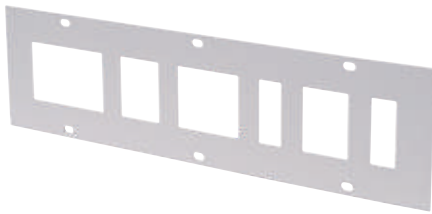

Cover plate for fuses

- Cover plate incl. pre-lasered cutouts for fuses

Item no.	Dimensions in mm (WxH)
07.861.13	375 x 125



Cover plate for fuse size 1

- Cover plate incl. pre-lasered cutouts for fuse

Item no.	Dimensions in mm (WxH)
07.861.27	125 x 125

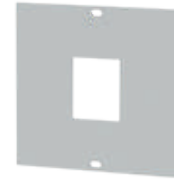

Cover plate for fuse size 2

- Cover plate incl. pre-lasered cutouts for fuses

Item no.	Dimensions in mm (WxH)
07.861.28	125 x 125



Cover plate for fuse size 3

- Cover plate incl. pre-lasered cutouts for fuses

Item no.	Dimensions in mm (WxH)
07.861.29	125 x 125



Cover plate for fuse size 4

- Cover plate incl. pre-lasered cutouts for fuses

Item no.	Dimensions in mm (WxH)
07.861.30	125 x 125



Installation contactor 20 A

- Size 1
- 230 V
- For earthed sockets

Item no.
03.74.16



Installation contactor 20 A

- Size 2
- 400 V
- For CEE sockets

Item no.
03.74.17



Circuit breaker B

- Size 1
- 1-pole 16 A
- 230 V
- For earthed sockets

Item no.
03.74.18



Circuit breaker C

- Size 3
- 3-pole 16 A
- 440 V
- For CEE sockets

Item no.
03.74.19



Earth leakage circuit breaker 25 A

- Size 2
- 230 V
- For earthed sockets

Item no.
03.74.20



Earth leakage circuit breaker 25 A

- Size 4
- 400 V
- For CEE sockets

Item no.
03.74.21

Multi-board

Multi-board accessories

Advantages of technical optimisation:

- Clean look
- Support column clearance minimised
- Ease of movement of the pivots can be adjusted with a screw (cannot be fully locked)
- Noise minimisation
- Withstands higher torsional moment
- Can also be mounted on superstructure stand with additional bracket



Pivot arm

- Dimensions in mm (WxDxH) 40 x 40 x 2 square tube
- Axle diameter 25 mm
- Load capacity 30 kg
- 4x plain bearing

Item no.	Dimensions in mm (WxDxH)
07.98.SA	332 x 40 x 40

Standard pivot arm bracket | Worktop

- For attachment to the worktop

Item no.	Version
07.98.01	For 40 x 40 x 2 mm pivot arm



Standard pivot arm bracket | Support column

- For lateral mounting at support column
- For holding the pivot arm

Item no.	Version
07.98.02	For 40 x 40 x 2 mm pivot arm



Please note:

Pivot arm bracket is mandatory



Pivot arm with depositing tray

Item no.	Dimensions in mm (WxDxH)
07.98.04	400 x 300 x 48



Pivot arm with inclinable tray

Item no.	Dimensions in mm (WxDxH)
07.98.13	450 x 350 x 40



Please note:

Pivot arm bracket is mandatory



Pivot arm with pivot frame and shelves

- With 2x inclinable shelf

Item no.	Dimensions in mm (WxDxH)
07.98.03	680 x 287 x 400



Pivot arm with document holder A4

- With raised lateral and bottom edge

Item no.	Dimensions in mm (WxDxH)
07.98.05	215 x 370 x 330



Pivot arm with document holder A4

- With raised bottom edge

Item no.	Dimensions in mm (WxDxH)
07.98.06	310 x 156 x 310



Pivot arm with monitor bracket

- VESA 75 / 100 mm

Item no.	Dimensions in mm (WxDxH)
07.98.07	700 x 370 x 320



Pivot arm with monitor bracket and inclined keyboard platform

- VESA 75 / 100 mm
- Platform made of sheet steel

Item no.	Dimensions in mm (WxDxH)
07.98.15	700 x 370 x 320



Pivot arm with monitor bracket and keyboard platform

- VESA 75 / 100 mm
- Beech multiplex shelf, 15 mm

Item no.	Dimensions in mm (WxDxH)
07.98.08	700 x 355 x 322

Multi-board

Multi-board accessories



Please note:

Pivot arm bracket is mandatory



Pivot arm with perforated/slotted wall

- For hooks and small parts boxes
- 1st side with slotted wall | 2nd side with perforated wall

Item no.	Dimensions in mm (WxDxH)
07.98.10	655 x 45 x 500



Application example

Open fronted storage bins

- 15 pieces

Item no.	Dimensions in mm (WxDxH)	Preis in €
07.45.26	–	43,91

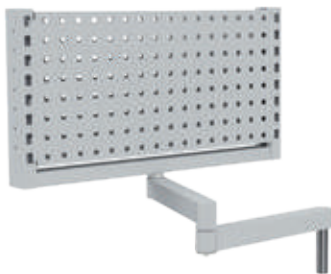

Pivot arm with perforated walls

- Perforated walls on both sides

Item no.	Dimensions in mm (WxDxH)
07.98.09	680 x 60 x 350



Pivot arm with shelf and ribbed rubber mat

Item no.	Dimensions in mm (WxDxH)
07.98.11	420 x 300 x 20



Pivot arm with shelf

- Beech multiplex 25 mm

Item no.	Dimensions in mm (WxDxH)
07.98.12	600 x 350

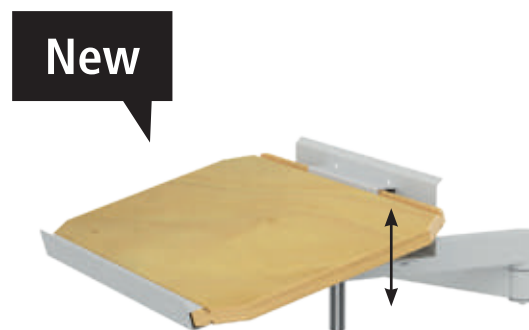

Pivot arm with shelf

- Beech multiplex 25 mm
- Tiltable

Item no.	Dimensions in mm (WxDxH)
07.98.14	400 x 182 x 100



Keyboard drawer underneath shelf

- For 320 und 420 mm deep shelves

Item no.	Dimensions in mm (WxDxH)
PTTAAUFB320	598 x 300 x 95



Tablet wall mount with pivot arm

- Universal and flexible applicable
- Optimum viewing distance thanks to individual table screen positioning
- Inclination range holder: -6° to +46°; rotatable: 180°
- Colour: silver metallic

Item no.	Dimensions in mm (WxDxH)	Mounting
07.8934LW	95 x 225 x 170	Perforated wall
07.8934TR		Support column

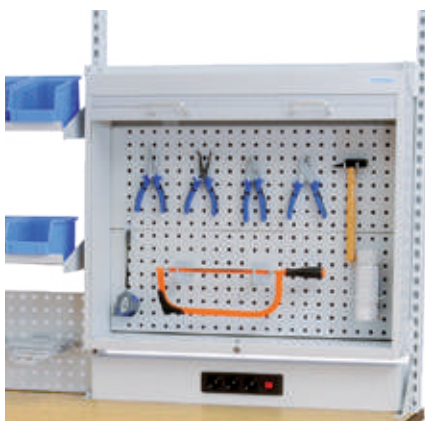

Roller shutter cabinet

- For hanging between the support columns
- Incl. 2x perforated wall

Item no.	Dimensions in mm (WxDxH)
03.990.01.14	910 x 220 x 820



Inclined support for bins

- For lateral mounting at support column
- Includes 6 bins, size 2

Item no.	Dimensions in mm (WxDxH)
07.89.37	350 x 110 x 82



Info bag, DIN A4

- For lateral mounting at support column

Item no.	Dimensions in mm (WxDxH)
07.89.15	216 x 35 x 333



Folder holder for support column

- For mounting on the support column

Item no.	Dimensions in mm (WxDxH)
03.900.40	120 x 300 x 340

Composition of the pivot frame for attachment to the multi-board

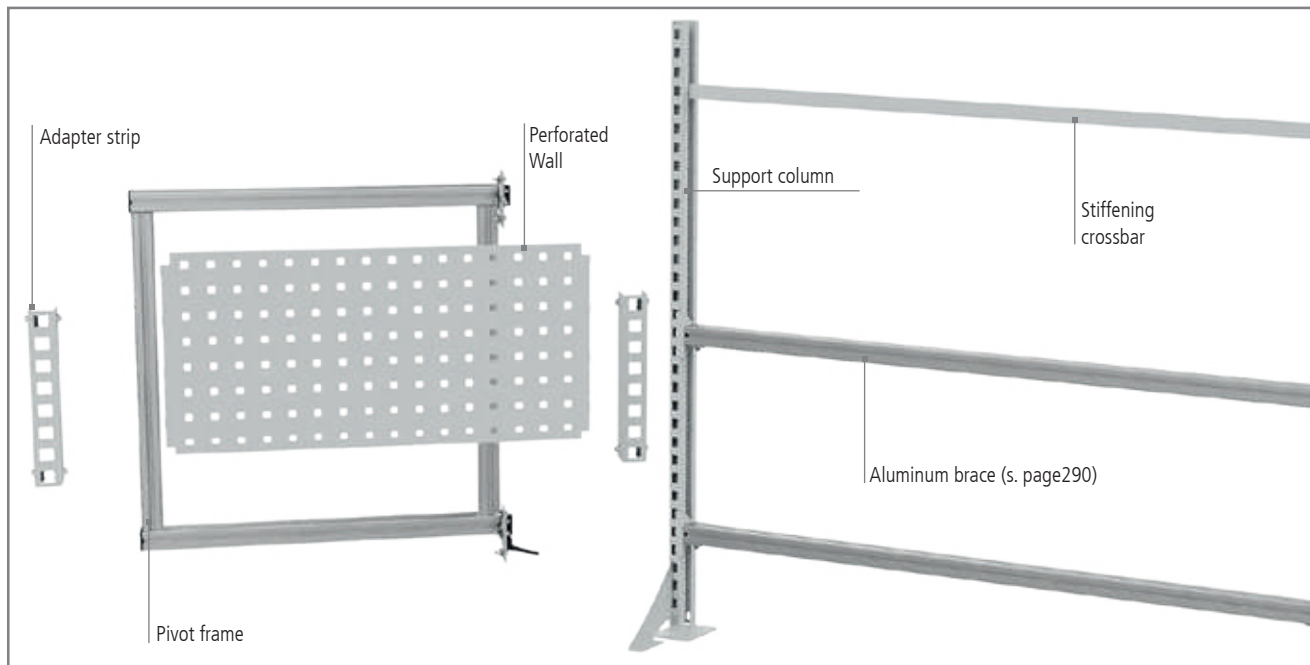

i Pivot frames can be use from a table width of 1250 mm

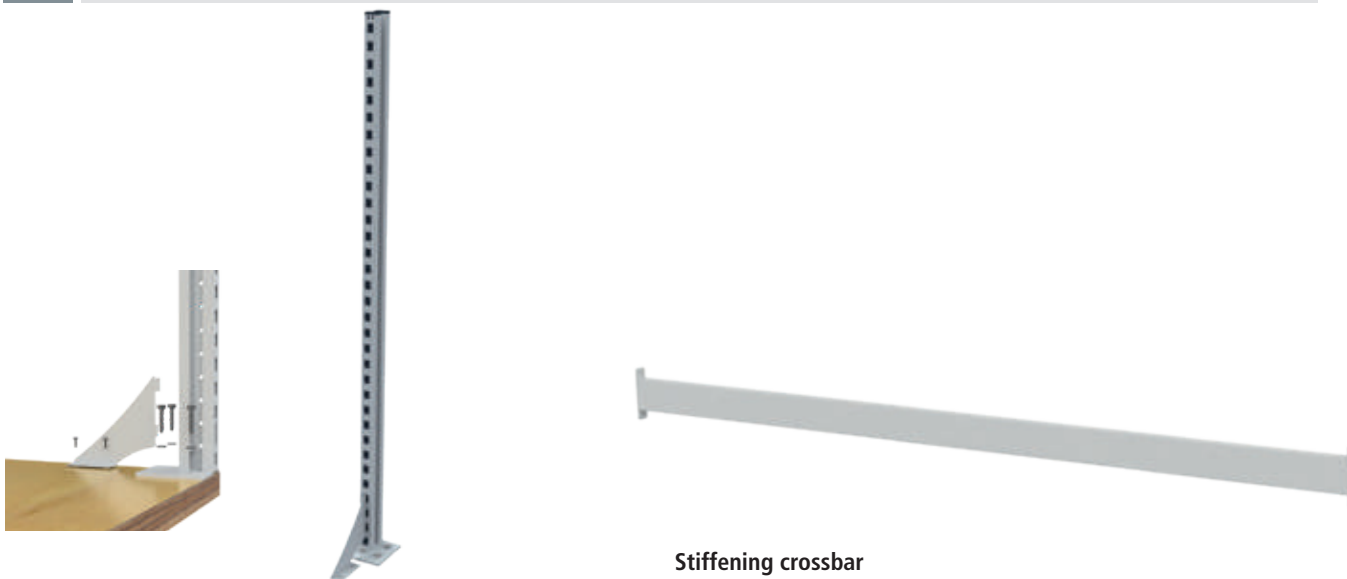

Support column 30 x 60 mm

- 1x support column right and 1 x support column left is required for mounting a stiffening crossbar
- Three support columns are required for installation on 2 m work surfaces (2 x left and 1 x right support column)
- Reinforced by U-profile tube
- Suitable for mounting an work surfaces from 40 mm height
- Thinner plate thicknesses on request

Item no.	Height in mm
03.935.125.240	1250 left
03.935.125.140	1250 right

Stiffening crossbar

- Mandatory when using a pivot frame

Item no.	Width in mm
03.935TR075	750
03.935TR100	1000
03.935TR125	1250
03.935TR150	1500
03.935TR175	1750
03.935TR200D	2000
03.935TR200	Consists of 2 x 950 mm corssbars (for two seperated 2000 mm Multi-boards)

Further add-on parts such as shelves, magnetic panels or energy bars can be found from page 278 onwards.

Is attached to the left or right side of the support column with 2 x hinges. Swivelling through hinges.



Pivot frame combination

- 1 x perforated wall
- 2 x shelf 220 mm depth, adjustable incline
- 4 x adapter strips

Item no.	Dimensions in mm (WxDxH)
07.98.7071	700 x 700 x 40



Pivot frame combination

- 2 x Aluminium brace
- 3 x Assembly swift 200 x 200 x 25 mm
- 1 x Assembly swift 400 x 200 x 25 mm
- Assembly swift can be installed straight or inclined

Item no.	Dimensions in mm (WxDxH)
07.98.7072	700 x 700 x 40



Pivot frame combination

- 1 x magnetic board
- 1 x perforated wall
- 4 x adapter strips
- 1 x assembly swift 400 x 200 x 25 mm
- Assembly swift can be installed straight or inclined

Item no.	Dimensions in mm (WxDxH)
07.98.7073	700 x 700 x 40



Pivot frame combination

- 1 x perforated wall
- 1 x shelf 220 mm depth, adjustable incline
- 4 x adapter strip
- 2 x Assembly swift 200 x 200 x 25 mm
- Assembly swift can be installed straight or inclined

Item no.	Dimensions in mm (WxDxH)
07.98.7074	700 x 700 x 40

Multi-Wand

New

Pivot frame attached to the support column, individual equipment

Attaches to the left or right side of the support column
Swivelling through hinges



Pivot frame

- Attaches to the left or right side of the support column with 2 x hinges
- Swivelling through hinges
- Regular multi-board accessories can be attached using adapter strips



Item no.	Dimensions in mm (WxDxH)
07.98.7070	700 x 700 x 40



Aluminium brace

- Attaches to the inside of the pivot frame

Item no.	Dimensions in mm (WxDxH)
07.98.7080-1	620 x 40 x 40

Adapter strip with screw joint

- 2 pieces
- Attaches to the aluminium profile
- Adapts regular multi-board accessories to the aluminium profile
- Required for perforated walls, magnetic boards and shelves



Item no.	Dimensions in mm (WxDxH)
07.98.7069	44,5 x 50 x 300

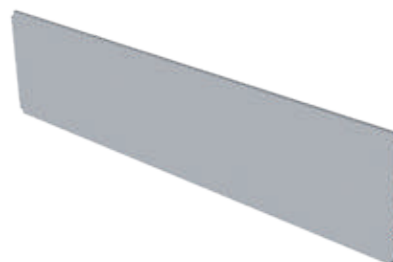

Magnetic board Requires adapter strip

Item no.	Dimensions in mm (WxDxH)
03.983.07SR	700 x 20 x 302



Shelf

Requires adapter strip

- Adjustable in inclination and height
- Inclination 0°, 10° und 20°, incl. roll-off edge



Item no.	Dimensions in mm (WxDxH)
03.907.220SR	700 x 220 x 20w

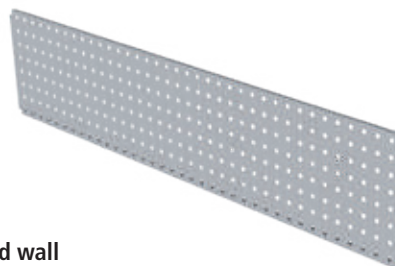

Perforated wall Requires adapter strip

- Grid 10x10 mm, 38 mm spacing

Item no.	Dimensions in mm (WxDxH)
03.983.101SR	700 x 20 x 302

Swivel frame for mounting on the worktop
Swivelling due to swivel arm



Pivot frame, for mounting on the worktop, swivelling

- Incl. swivel arm and swivel arm holder
- Regular multi-board accessories can be attached using adapter strips s. page kann 295

Item no.	Dimensions in mm (WxDxH)
07.98.8010	700 x 700 x 40

Pivot frame, for mounting on the worktop,

- Incl. swivel arm holder
- Regular multi-board accessories can be attached using adapter strips s. page kann 295

Item no.	Dimensions in mm (WxDxH)
07.98.8020	700 x 700 x 40

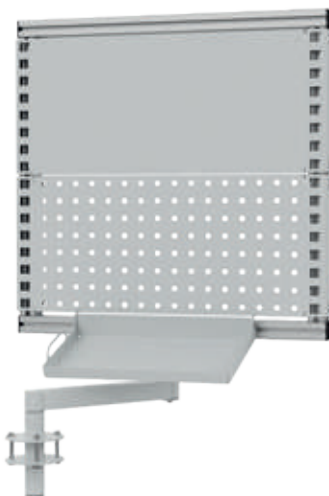

Pivot frame combination, for mounting on the worktop, swivelling

- Incl. swivel arm and swivel arm holder
- 1 x magnetic board
- 1 x perforated wall
- 4 x adapter strip
- 1 x assembly swift 400 x 200 x 25 mm
- Assembly swift can be installed straight or inclined

Item no.	Dimensions in mm (WxDxH)
07.98.8011	700 x 700 x 40

Pivot frame, for mounting on the worktop,

- Incl. swivel arm holder
- 3 x shelf 220 mm depth, adjustable incline
- 4 x adapter strip

Item no.	Dimensions in mm (WxDxH)
07.98.8021	700 x 700 x 40

Composition of the aluminium brace for attachment to the multi-board

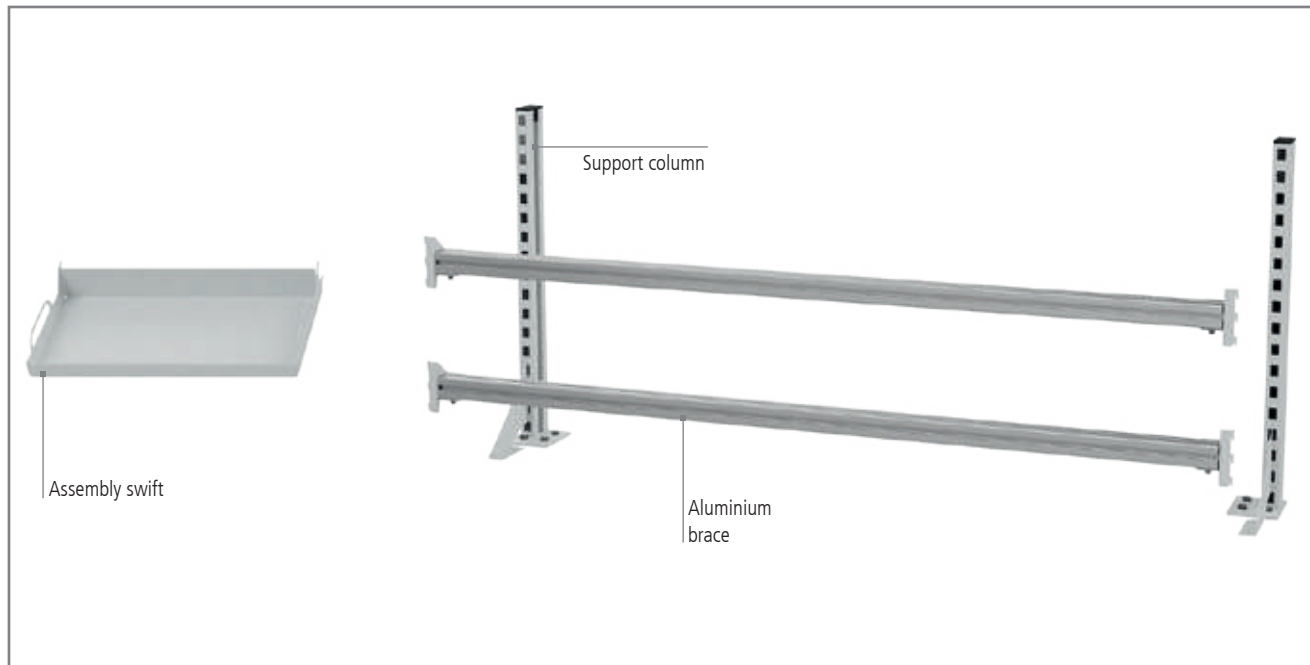

Support column 30 x 60 mm

- 1x support column right and 1 x support column left is required for mounting a stiffening crossbar
- Three support columns are required for installation on 2 m work surfaces (2 x left and 1 x right support column)
- Reinforced by U-profile tube
- Suitable for mounting an work surfaces from 40 mm height
- Thinner plate thicknesses on request

Item no.	Height in mm
03.935.125.240	1250 left
03.935.125.140	1250 right

Aluminium brace

- For suspension on support column
- Assembly swifts can be hooked onto the aluminium profile strut. eingehängt werden
- Incl. 2 x adapter strip
- 40 kg carrying capacity



Item no.	v)
07.98.7080	700 x 40 x 40
07.98.7081	1000 x 40 x 40
07.98.7082	1250 x 40 x 40
07.98.7083	1500 x 40 x 40
07.98.7084	1750 x 40 x 40
07.98.7085	For width 2000 mm, consists of 2 x Aluminium brace 1000 x 40 x 40

Assembly swift

- Plug-in system for aluminium profiles
- Quick and flexible attachment in the groove of the aluminium profiles
- Easy handling
- Versatile workplace design
- Quick and easy to stow away after use
- 12 kg load capacity

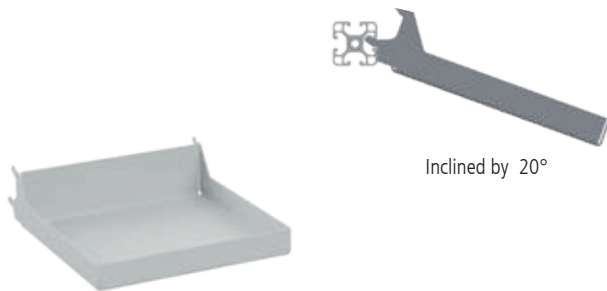

New



Assembly swift 2 level

- Is hooked into the groove of the aluminium profile
- 0° horizontal (upper hook)
- 20° inclined (lower hook)
- Ideal for tool inlets, ribbed rubber or as a holder for plastic boxes, screws and small assembly parts

Item no.	Dimensions in mm (WxDxH)
07.98.7090	200 x 200 x 25

Assembly swift 2 level with handle

- Is hooked into the groove of the aluminium profile
- 0° horizontal (upper hook)
- 20° inclined (lower hook)
- Ideal for tool inlets, ribbed rubber or as a holder for plastic boxes, screws and small assembly parts
- Matching tool inlets can be found on page 472/473

Item no.	Dimensions in mm (WxDxH)
07.98.7091	400 x 200 x 25

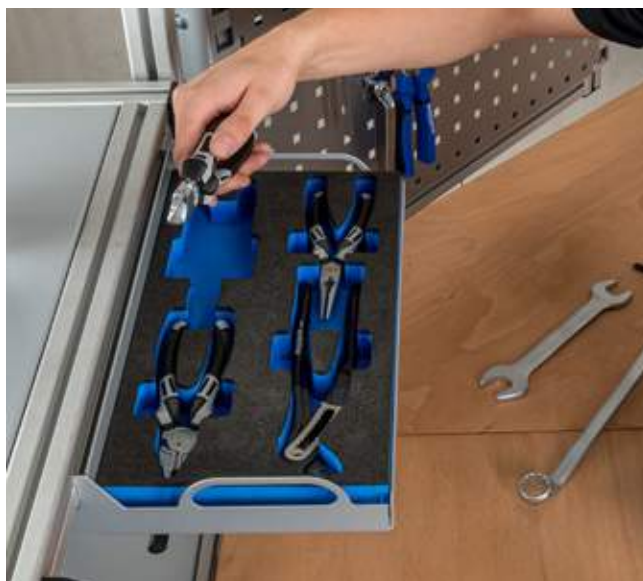

The Assembly swift is perfect for storing inlets or tools in a drawer and hooking them into the aluminium profile strut for easy access when needed.

Multi-board

Tablet stands

- Variable for holding all tablet sizes from 7" to 13"
- Symmetrical opening of the stands
- Easy insertion and removal of the tablet
- Rotatable: 360° for portrait and landscape format – with locking points every 90°
- Anti-theft protection, effective protection against the lateral removal of the tablet
- Cable management, opening in the stand serves as a duct for the tablet charging cable



Anti-theft protection



Tablet table stand

- Aluminium, steel and high-quality plastics
- Elegant and clear lines with a fine matt-finished surface
- Has stepless angle variability from 0° to 88°
- Additional anti-theft protection thanks to cable lock
nicht im Lieferumfang enthalten
- Colour: Silver metallic

Item no.	Dimensions in mm (WxDxH)
07.8930	155 x 183 x 242



Tablet wall mount

- Secure and flat mounting at walls/multi-walls
- Universally and flexibly applicable
- Simple assembly
- Colour: Silver metallic

Item no.	Dimensions in mm (WxDxH)
07.8933	85 x 180 x 50



Tablet table stand with pivot arm

- Optimum viewing distance thanks to individual tablet screen positioning
- Table column height: 295 mm
- Inclination range holder: -6° to +46°; rotatable: 180°
- Arm radius: 365 mm; swivelling: 180°
- Table clamp dimensions: tabletop thicknesses up to 40 mm
- Colour: Silver metallic

Item no.	Dimensions in mm (WxDxH)
07.8931	100 x 210 x 440



Tablet wall mount with pivot arm

- Universal and flexible applicable
- Optimum viewing distance thanks to individual table screen positioning
- Inclination range holder: -6° to +46°; rotatable: 180°
- Colour: silver metallic

Item no.	Dimensions in mm (WxDxH)	Mounting
07.8934LW	95 x 170 x 225	Perforated wall
07.8934TR		Support column



Container carrier 1000 mm

- Mounting between two support columns
- Including open fronted storage bins

Item no.	open fronted storage bins in mm	Piece
03.900.012	Size 2: 100 x 170 / 140 x 80	8
03.900.013	Size 3: 145 x 230 / 195 x 125	6
03.900.015	Size 5: 200 x 350 / 300 x 200	4



Container carrier 1000 mm

- Mounting between two support columns
- Including open fronted storage bins

Item no.	Dimensions in mm (WxDxH)	Piece
07.89.19	145 x 230 x 125	6
07.89.53	100 x 170 x 80	8



Container carrier 1250 mm

- Mounting between two support columns
- Including open fronted storage bins

Item no.	Dimensions in mm (WxDxH)	Piece
07.89/125.24	145 x 230 x 125	7
07.89/125.23	100 x 170 x 80	11



Container carrier 1500 mm

- Mounting between two support columns
- Including open fronted storage bins

Item no.	Dimensions in mm (WxDxH)	Piece
07.89.24	145 x 230 x 125	9
07.89.23	100 x 170 x 80	13



Rail for open fronted storage bins on perforated wall

Item no.	Length in mm
03.900.06	300
03.900.05	450



Rail for open fronted storage bins between support columns

Item no.	Length in mm
07.89BTR10-0	1000
07.89BTR12-0	1250
07.89BTR15-0	1500



Open fronted storage bins

- Made of polypropylene (lids on request)

Item no.	Dimensions in mm (WxDxH)
03.900.001	100 x 95 / 65 x 50
03.900.002	100 x 175 / 140 x 75
03.900.003	145 x 235 / 195 x 125

New



Application example

Document holder for rail between support columns

- 1 x A4 document holder
- Can be mounted on rail for open fronted storage bins

Item no.	Dimensions in mm (WxDxH)
03.900.38	216 x 21 x 312

Workbench accessories

Workplace lighting



LIGHTING

Ideal illumination and improved field of vision guaranteed

Work and sight are inextricably linked in most occupations. Particular attention must therefore be paid to light at the workplace. With its high-quality work lights, Bedrunka+Hirth guarantees ideal illumination, improved visual comfort and the implementation of or compliance with workplace guidelines with regard to lighting assistance in the workplace environment.

80% of all sensory impressions experienced during a working day are perceived by sight. Poor visual conditions can have a negative impact on our entire body. Discomfort, headaches, irritated eyes and other symptoms of illness increase markedly. This is of particular significance at the workplace.

Of crucial importance are the requirements that need to be met directly at the job site. These requirements are so varied that a single appropriate, generally applicable workplace lighting system is not possible. Rather, the individual features of the respective work process provide the parameters for optimal light.



LIGHTING AND PERFORMANCE AT WORK

DIN EN 12464-1 deals with the requirements for lighting in indoor workplaces. The aim is to achieve optimum visual performance and comfort for people with normal vision so that individual visual tasks can be performed in the best possible way. Depending on the complexity of the tasks, significant improvements in performance can be achieved by using the correct illuminance. At the same time, compliance with this guideline prevents health impairments.

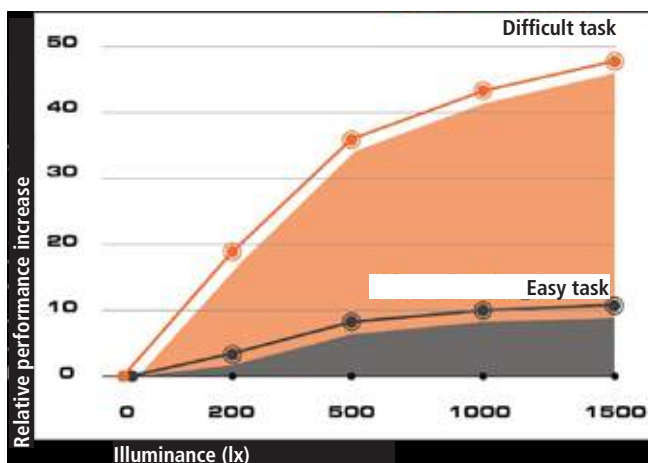

Examples of recommended illuminance levels:

Illuminance	Scope of application
500 lx	Testing and measuring workstations
500 lx	Computer workstations
1.000 lx	Fixture and jig construction
1.000 lx	Micromechanics
1.000 lx	Final inspection
1.000 lx	Color inspection
1.000 lx	Quality control
1.500 lx	Electronics workshop

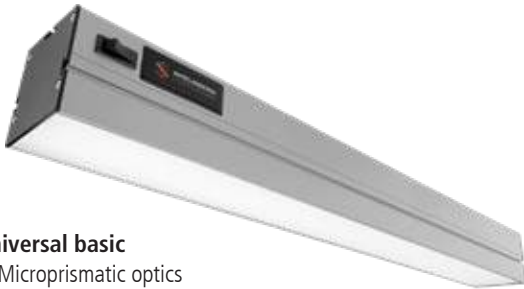
Universal LED workplace lamp**Universal basic**

- Microprismatic optics
- Uniform illumination
- Suitable for reflective surfaces

Universal power:

- LED optics 3-row
- High illuminance
- High energy efficiency

Premium LED workplace lamp**Premium basic-line:**

- Microprismatic optics
- Uniform illumination
- Suitable for reflective surfaces

Premium eco-line/power-line:

- Parabolic louvre
- Outstanding glare control UGR<19
- High illuminance

Intelligente LED workplace lamp**Premium Sense DIM**

- Integrated brightness and motion sensor
- Automatic brightness control and on/off switching
- Programming via pushbutton

Premium Sense Remote DIM:

- Integrated brightness and motion sensor
- Automatic brightness control and on/off switching
- Programming via IR remote control

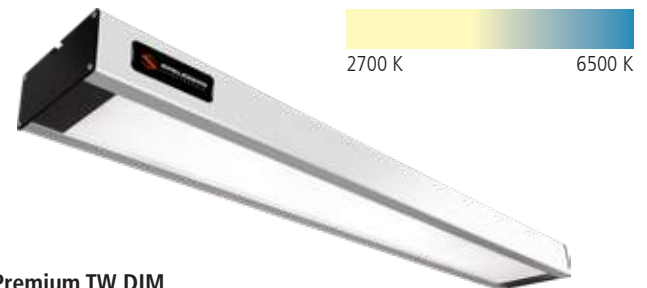
Premium LED workplace lamp, tunable white and dimmable**Premium TW DIM**

- Color temperature and dimmability controllable via push button
- Light colors continuously adjustable from 2700 K to 6500 K

Premium TW App connect DIM:

- Color temperature and dimmability controllable via app
- Light colors programmable and reproducible from 2700 K to 6500 K
- Create different light scenes
- Network and control up to 64 luminaires

LED testing workplace lamp VDA**LED test workplace lamp VDA 16**

- Brightness control via touch dimmer
- Light colors 6500 k and 4000 k alternating
- Color rendering > RA90
- Average illuminance > 2300 lux

**Cros-linkable test workplace lamp VDA 16**

- Brightness control via app or remote control
- Light colors 6500 k and 4000 k alternating
- Light scenes programmable and reproducible
- Color rendering > RA90
- Average illuminance > 2300 lux
- Network and control up to 64 luminaires

Workbench accessories

Lighting

New

Universal LED workplace lamp basic

- Colorless anodized aluminum housing
- Integrated on/off switch
- Color rendering Ra > 80
- UGR < 22
- Dimmable upon request
- Life time L80/B10 at 50.000h
- Color temperature 5.000 K

Included in delivery:

- 1x mounting kit, standard
- 4 m connection cable

Universal LED workplace lamp power

- Colorless anodized aluminum housing
- Integrated on/off switch
- Color rendering Ra > 85
- UGR < 19
- Dimmable upon request
- Life time L80/B10 at 50.000h
- Color temperature 5.000 K

Included in delivery:

- 1x mounting kit, standard
- 4 m connection cable

LED Microprismatic optics



Universal 600 | basic

- System output approx. 19,9 W
- Luminaire luminous flux approx. 1911 lm
- Average illuminance 859 lx*

Item no.	Dimensions in (WxDxH)
03L06M50B	582 x 70 x 80

LED optics 3-row 60° frosted



Universal 600 | power

- System output approx. 11,8 W
- Luminaire luminous flux approx. 1620 lm
- Average illuminance 1101 lx*

Item no.	Dimensions in (WxDxH)
03L06O350P	582 x 70 x 80

Universal 900 | basic

- System output approx. 28,9 W
- Luminaire luminous flux approx. 2867 lm
- Average illuminance 1290 lx*

Item no.	Dimensions in (WxDxH)
03L09M50B	868 x 70 x 80

Universal 900 | power

- System output approx. 16,7 W
- Luminaire luminous flux approx. 2427 lm
- Average illuminance 1502 lx*

Item no.	Dimensions in (WxDxH)
03L09O350P	868 x 70 x 80

Universal 1200 | basic

- System output approx. 37,8 W
- Luminaire luminous flux approx. 3822 lm
- Average illuminance 1226 lx*

Item no.	Dimensions in (WxDxH)
03L12M50B	1154 x 70 x 80

Universal 1200 | power

- System output approx. 21,6 W
- Luminaire luminous flux approx. 3239 lm
- Average illuminance 1428 lx*

Item no.	Dimensions in (WxDxH)
03L12O350P	1154 x 70 x 80

Universal 1500 | basic

- System output approx. 46,8 W
- Luminaire luminous flux approx. 4778 lm
- Average illuminance 1533 lx*

Item no.	Dimensions in (WxDxH)
03L15M50B	1440 x 70 x 80

Universal 1500 | power

- System output approx. 26,5 W
- Luminaire luminous flux approx. 4047 lm
- Average illuminance 1728 lx*

Item no.	Dimensions in (WxDxH)
03L15O350P	1440 x 70 x 80

Premium LED workplace lamp basic-line e

Anodised aluminium housing, natural colour

- Three-part light control system incl. microprismatic disc
- Integrated on/off switch and device connector plug for connection to mains voltage
- Additionally with internal feed-through wiring 3 x 1.5 mm² and an integrated connection socket for connecting a further lamp.
- Colour rendering Ra > 80
- UGR < 22
- Colour temperature 5000 K
- Service life: 50,000 hours (L80/B10)

Scope of delivery:

- 1x 4 m connection cable with earthed plug and
- 1x mounting kit, standard

**LED workplace lamp basic line e****LED workplace lamp | 600**

- System output approx. 19 W
- Luminous flux approx. 1850 lm
- Average illuminance 832 lx*

Item no.	Length in mm
03L06M50E	631

LED workplace lamp | 900

- System output approx. 28.5 W
- Luminous flux approx. 2774 lm
- Average illuminance 1248 lx*

Item no.	Length in mm
03L09M50E	899

LED workplace lamp | 1200

- System output approx. 36.5 W
- Luminous flux approx. 3699 lm
- Average illuminance 1443 lx*

Item no.	Length in mm
03L11M50E	1186

LED workplace lamp basic line e | dimmable**LED workplace lamp | 900, dimmable**

- System output approx. 32.5 W
- Luminous flux approx. 3148 lm
- Average illuminance 1417 lx*

Item no.	Length in mm
03L09M50D	899

LED workplace lamp | 1200, dimmable

- System output approx. 41.5 W
- Luminous flux approx. 4198 lm
- Average illuminance 1637 lx*

Item no.	Length in mm
03L11M50D	1186

LED workplace lamp basic line p**LED workplace lamp | 600**

- System output approx. 27 W
- Luminous flux approx. 2588 lm
- Average illuminance 1165 lx*

Item no.	Length in mm
03L06M50P	631

LED workplace lamp | 1200

- System output approx. 51.5 W
- Luminous flux approx. 5176 lm
- Average illuminance 2019 lx*

Item no.	Length in mm
03L11M50P	1186

LED workplace lamp | 900

- System output approx. 39.5 W
- Luminous flux approx. 3882 lm
- Average illuminance 1747 lx*

Item no.	Length in mm
03L09M50P	899

*Measurement conditions: Height: 1000 mm;
Measuring surface: 1000 x 555 mm

Workbench accessories

Lighting

Premium LED workplace lamp | eco-line and power-line

- Colorless anodized aluminum housing
- Integrated unit connector
- With internal through-wiring 3 x 1,5 mm² and integrated connection socket for connecting an additional lamp
- Three-part light directing system incl. parabolic louvre
- Color rendering Ra > 80
- UGR < 19
- Color temperature 5000 K
- Life time: 50.000 h (L80/B10)

Included in delivery:

- 1x mounting kit, standard
- 4 m connection cable



LED workplace lamp | eco-line

LED workplace lamp | 600

- System output approx. 19 W
- Luminaire luminous flux approx. 1674 lm
- Average illuminance 753 lx*

Item no.	Length in mm
03L06R50E	631

LED workplace lamp | 900

- System output approx. 28,5 W
- Luminaire luminous flux approx. 2511 lm
- Average illuminance 1130 lx*

Item no.	Length in mm
03L09R50E	899

LED workplace lamp | 1200

- System output approx. 36,5 W
- Luminaire luminous flux approx. 3348 lm
- Average illuminance 1306 lx*

Item no.	Length in mm
03L11R50E	1186

LED workplace lamp | power-line

LED workplace lamp | 600

- System output approx. 27 W
- Luminaire luminous flux approx. 2342 lm
- Average illuminance 1054 lx*

Item no.	Length in mm
03L06R50P	631

LED LED workplace lamp | 1200

- System output approx. 51,5 W
- Luminaire luminous flux approx. 4685 lm
- Average illuminance 1827 lx*

Item no.	Length in mm
03L11R50P	1186

LED Arbeitsplatzleuchte | eco-line dimmable

LED workplace lamp | 900 dimmbar

- System output approx. 32,5 W
- Luminaire luminous flux approx. 2850 lm
- Average illuminance 1282 lx*

Item no.	Length in mm
03L09R50D	899

LED workplace lamp | 1200 dimmable

- System output approx. 41,5 W
- Luminaire luminous flux approx. 3799 lm
- Average illuminance 1482 lx*

Item no.	Length in mm
03L11R50D	1186

*Measuring conditions: Height: 1000 mm; Measuring surface: 1000 x 555 mm

LED Sensor workplace lamp | automatic brightness control

- Colorless anodized aluminum housing
- Integrated unit connector
- With internal through-wiring 3 x 1,5 mm² and integrated connection socket for connecting an additional lamp
- Color temperature 5000 K
- Life time: 50.000 h (L80/B10)

Included in delivery:

- IR remote control
- Shutter to limit motion detection
- 1 x 4 m connection cable with Schuko plug and
- 1 x mountin kit, standard
- Motion sensor



IR remote control

- Motion detector (switch-on and switch-off times programmable)
- Brightness sensor (programmable)
- Dimmer via remote control
- Shutter (limit detection range)



LED Sensor workplace lamp | eco-line

- Three-part light directing system incl. parabolic louvre
- Color rendering Ra > 80
- UGR < 19

LED Sensor workplace lamp | 900

- System output approx. 32,5 W
- Luminaire luminous flux approx. 2850 lm
- Average illuminance 1282 lx*

Item no.	Length in mm
03L09R50SEND	899

LED Sensor workplace lamp | 1200

- System output approx. 41,5 W
- Luminaire luminous flux approx. 3799 lm
- Average illuminance 1482 lx*

Item no.	Length in mm
03L11R50SEND	1186

LED Sensor workplace lamp | basic-line

- Three-part light directing system incl. parabolic louvre
- Color rendering Ra > 80
- UGR < 22

LED Sensor workplace lamp | 900

- System output approx. 32,5 W
- Luminaire luminous flux approx. 3148 lm
- Average illuminance 1417 lx*

Item no.	Length in mm
03L09M50SEND	899

LED Sensor workplace lamp | 1200

- System output approx. 41,5 W
- Luminaire luminous flux approx. 4198 lm
- Average illuminance 1637 lx*

Item no.	Length in mm
03L11M50SEND	1186

*Measurement conditions: Height: 1000 mm; Measuring surface: 1000 x 555 mm

Workbench accessories

Wireless workplace lamps

Premium LED workplace lamp, Tunable white and dimmable

- Colorless anodized aluminum housing
- Integrated unit connector

Tunable white

- Color temperature adjustable from 2700 K to 6500 K
- Brightness and color temperature can be adjusted for individual adaption to the workplace



New



LED workplace lamp | basic-line

- Three-part light directing system incl. parabolic louvre
- Color rendering Ra 90
- UGR < 22
- Life time: 50.000 h (L80/B10)

LED wireless workplace lamp | 900

- System output approx. 46 W
- Luminaire luminous flux approx. 3494 lm
- Average illuminance 1572 lx*

Item no.	Length in mm	Version
03L09M27-65D	899	wireless
03L09M2765DT		switch

LED wireless workplace lamp | 1200

- System output approx. 61 W
- Luminaire luminous flux approx. 4658 lm
- Average illuminance 1817 lx*

Item no.	Length in mm	Version
03L11M27-65D	1186	wireless
03L11M2765DT		switch

- Integrated Bluetooth controller for iOS and Android application.
- With internal through-wiring 3 x 1,5 mm² and integrated connection socket for connecting an additional lamp

Included in delivery:

- 1 x 4 m connection cable with Schuko plug and
- 1 x mounting kit, standard



Switch control

- Adjust Tunable white and brightness via switch control
- Color temperature stepless adjustable from 2700 K for 6500 K



App connect DIM (wireless)

- Adjust Tunable white and brightness via App
- Programmable via mobile device app
- A commercially available smartphone or tablet with the appropriate software is required. Not included in delivery



LED workplace lamp | eco-line

- Three-part light directing system incl. parabolic louvre
- Color rendering Ra 90
- UGR < 19
- Life time: 50.000 h (L80/B10)

LED wireless workplace lamp | 900

- System output approx. 46 W
- Luminaire luminous flux approx. 3494 lm
- Average illuminance 1130 lx*

Item no.	Length in mm	Version
03L09R27-65D	899	wireless
03L09R2765DT		switch

LED wireless workplace lamp | 1200

- System output approx. 61 W
- Luminaire luminous flux approx. 4216 lm
- Average illuminance 1644 lx*

Item no.	Length in mm	Version
03L11R27-65D	1186	wireless
03L11R2765DT		switch

Test workstations according to standard VDA 16

Our ergonomic solutions to support your testing and evaluation processes of decorative surfaces.

Often the quality of a surface cannot be measured, but only assessed subjectively. This appearance-dependent assessment requires, on the one hand, optimum illumination of the test parts and, on the other hand, shielding of the test parts from changing and disturbing extraneous light influences in order to guarantee the reproducibility of the test process.

The German Association of the Automotive Industry (VDA) has published a uniform standard for quality assurance in Volume 16. The guideline, known as VDA 16 for short, is primarily aimed at suppliers and customers who deal with decorative surfaces in the visible area, regulates the underlying test conditions and thus enables a universal and uniform assessment basis across manufacturers. It provides clarity and bindingness with regard to the characteristics of appearance-dependent surfaces and their description.

Our ergonomic test workplaces meet all the requirements of VDA 16 with regard to shielding, illuminance, light colours and colour rendering index. These are in detail:

- Illuminance at least 1000 Lux at the test object
- Color temperature 4000 K and 6500 K
- Color rendering RA >90

In addition, the illumination can be individually adapted to the material and surface by dimming the individual light colours. Several modules can be defined as a group, mounted as a row and controlled together. Light scenes can be programmed, saved and reproducibly recalled without limitation at part level. In addition to a remote control, we offer the option of being able to control the VDA 16 module luminaire via free app control with a smartphone or tablet.

Our test workstations provide you with sustainable support in implementing the required test conditions. The ergonomically and lighting-specific well thought-out design enables you to meet the demanding requirements of the future and to be prepared for the future.

New

LED test workplace lamp VDA 16

- Colorless anodized aluminum housing
- Brightness stepless adjustable
- Life time L80/B10 bei 50.000h
- Direct illumination
- Color reproduction Ra >90
- UGR <22 system output approx. 74 W
- Also available with color temperature 4.000 - 6.500 -4.000

Included in delivery:

- 1 x mounting kit, standard
- 4 m connection cable with Schuko plug

**LED test workplace lamp VDA 16 | 600**

- Luminaire luminous flux approx. 6.586 lm
- Average illuminance 2386 lx*

Item no.	Dimensions in (WxDxH)	Color temperature
03LVDA3-0600	582 x 210 x 80	6.500 - 4.000 - 6.500

LED-test workplace lamp VDA 16 | 900

- Luminaire luminous flux approx. 9.879 lm
- Average illuminance 3448 lx*

Item no.	Dimensions in (WxDxH)	Color temperature
03LVDA3-0900	868 x 210 x 80	6.500 - 4.000 - 6.500

LED-test workplace lamp VDA 16 | 1200

- Luminaire luminous flux approx. 13.173 lm
- Average illuminance 3971 lx*

Item no.	Dimensions in (WxDxH)	Color temperature
03LVDA3-1200	1154 x 210 x 80	6.500 - 4.000 - 6.500

Workbench accessories

Test workplace lamp

New



Android-Version



IOS-Version



LED test workplace lamp VDA 16

- Colorless anodized aluminum housing
- Brightness stepless adjustable
- Life time L80/B10 bei 50.000h
- Direct illumination
- Color reproduction Ra >90
- UGR <22 system output approx. 103 W
- Luminaire luminous flux approx. 12.309 lm
- Average illuminance 2312 lx*
- Connect up to 63 lamps
- Programmable and operable via mobile device app

Item no.	Dimensions in mm (WxDxH)
03PPLVDA16	595 x 540 x 57



Basic DIM Wireless User Interface

- Access to all important functions
- Enables control of all luminaires in the network
- Required for LED test workplace luminaire VDA 16

Item no.
03FBDIM

Test station with beech multiplex worktop 25 mm

- worktop: 1170/1420 x 800 x 25 mm
- Load capacity 350 kg
- Incl. lighting

Item no.	Dimensions in mm (WxDxH)
03PPBM125	1250 x 840 x 1950
03PPBM150	1500 x 840 x 1950

Example of the use of the test workplace lamp in a test station.



Satellite workplace lamps

- Anodised aluminium housing, natural colour
- Integrated on/off switch and device connector plug for connection to mains voltage
- For mounting on a vertical profile
- Colour temperature 5000 K
- Service life: 50,000 hours (L80/B10)

Scope of delivery:

- Mounting bracket for installation on commercially available profile systems
- 1x 4 m connection cable with earthed plug and 1x mounting kit, standard



Satellite workplace lamp | basic-line

- Three-part light control system incl. microprismatic disc
- UGR < 22
- System output 10 W
- Luminous flux approx. 925 lm
- Colour rendering Ra > 80

Item no.	Length in mm
03L43SATML	430 mm Left version
03L43SATMR	430 mm Right version

Satellite workplace lamp | eco-line

- Three-part light control system incl. parabolic louvre
- UGR < 19
- System output 10 W
- Luminous flux approx. 837 lm
- Colour rendering Ra > 80

Item no.	Length in mm
03L43SATRL	430 mm Left version
03L43SATRR	430 mm Right version

*Measurement conditions: Height: 1000 mm; Measuring surface: 1000 x 555 mm



Accessories

New



Zubehörsatz für Arbeitsplatzleuchten schwenkbar

- 2 pieces

Item no.	Height in mm	Suitable for
4016221000	80	LED lamp premium (page 299-302)
4016137000	80	LED lamp universal (page 298)



Workbench accessories

Lighting



LED all-round workplace lamp

- Slim, particularly energy-efficient universal lamp for workplaces with high lighting requirements
- Incl. 14 W or 28 W LED light engine, up to 150 lm/W; dimmable (option), with ball joint
- Colour: Silver
- Available with 4000 K or 5000 K colour temperature
- CRI > 80
- Screw-on flange 60x60 mm

Item no.	Length in mm Version
03L287144	355 mm 14 W, 4000 K, nonDIM
03L287145	355 mm 14 W, 5000 K, nonDIM
03L287146	355 mm 14 W, 4000 K, DIM
03L287147	355 mm 14 W, 5000 K, DIM
03L287284	577 mm 28 W, 4000 K, DIM
03L287285	577 mm 28 W, 5000 K, DIM



LED-RLL Flex magnifier lamp

- Magnifier lamp incl. screw-on flange

Item no.	Version
03.960.54	3 dioptre
03.960.55	5 dioptre



Table clamp for screw-on flange 60 mm

- For LED all-round workplace lamp and LED-RLL Flex magnifier lamp
- Colour: Silver

Item no.
03.960.52



COOL FLEX LED

- LED flex arm lamp with 14 W TC 11 W/900 lm
- LED engine integrated in lamp base
- Colour temperature 5000 K, CRI > 80
- Dimmable in the range of 25 – 100 % via rotary knob
- Mounting: Screw-on base 70 x 70 mm (integrated)
- Colour: Silver/Black
- Fully flexible
- Robust metal hose with shrink sleeve coating

Item no.	Version
03L61490	Flex arm 500, lighting unit 295



LED-Flex 3

- 3x high-power LED
- Brilliant white
- High vibration and shock resistance
- Fully flexible
- Robust metal hose 300 mm
- Handle on head
- Colour: Black

Item no.	Version
03.960.46	Flex arm 520, lighting unit Ø 75



Table clamp for screw-on flange 40 mm

- For Cool-Flex LED and LED-Flex 3
- Colour: Black

Item no.
03.960.90

*Measurement conditions: Height: 1000 mm; Measuring surface: 1000 x 555 mm

Perforated wall system

Multi-board setup

Perforated wall system: The right hook for every tool. The hooks can be easily hung and clicked into the required perforation. Nothing wobbles and the hooks remain in place. Please also specify the desired colour. Delivered in our standard colours without extra charge. If no colour is specified, we will supply RAL 7035 light grey. Standard colours see page 27

- Clearly arranged and space-saving storage of tools, small parts and working materials
- Powder coated
- Reinforced by beams

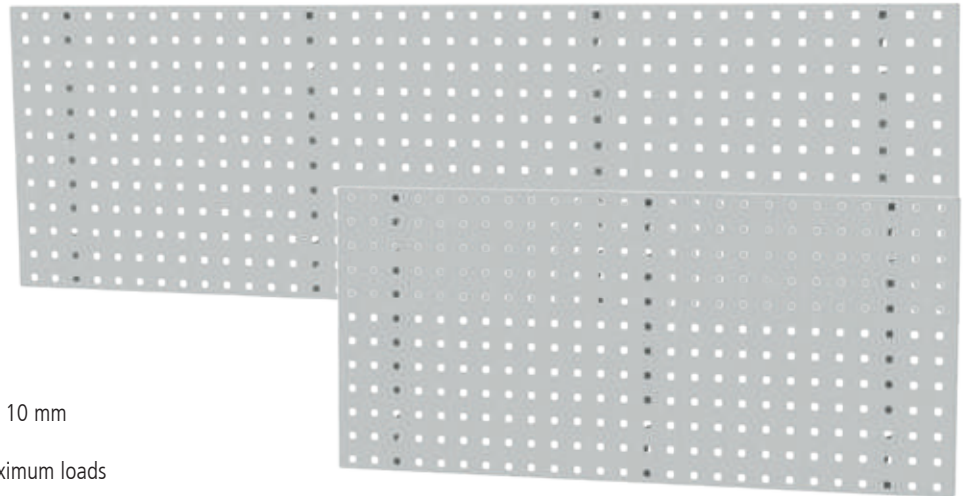

Perforated wall

- Steel plate, square perforation, 10 x 10 mm
- Bevelled all-round
- Stiffened with strong beams for maximum loads
- Easy wall mounting
- Spacing 38 x 38 mm

Item no.	Dimensions in mm
03.87.101-1	500 x 450
03.87.102-1	1000 x 450
03.87.103-1	1500 x 450
03.87.104-1	2000 x 450



Quickly connects the hooks to the perforated wall without the use of tools.

Workbench bracket

- Recommendation for
- 1000 mm - 2 brackets
 - 1500 mm - 3 brackets
 - 2000 mm - 3 brackets

Item no.	Version
03.87.043-1	for one perforated wall
03.87.044-1	For 2 perforated walls one above the other



Workbench accessories ON THE WORKBENCH



Flat screen mount
07.45.21



Flat screen mount for perforated wall

Item no.	Dimensions in mm (WxDxH)
07.45.21	160 x 30 x 210



Swivelling monitor holder, for mounting on the flat screen mount

- VESA standard

Item no.	Dimensions in mm (WxDxH)
07.45.22	125 x 75 x 125



Rail for open fronted storage bins on perforated wall

Item no.	Length in mm
03.900.06	300
03.900.05	450



Open fronted storage bins

- Made of polypropylene (lids on request)

Item no.	Dimensions in mm (WxDxH)
03.900.001	100 x 95 / 65 x 50
03.900.002	100 x 175 / 140 x 75
03.900.003	145 x 235 / 195 x 125



Tool holder with slanted hook end

■ Ø 6 mm

Item no.	Dimension in mm (W)
03.87.301	50
03.87.302	100
03.87.303	150
03.87.304	200



Tool holder with vertical hook end

■ Ø 6 mm

Item no.	Dimension in mm (W)
03.87.311	35
03.87.312	75
03.87.313	125



Tool holder with straight hook end

■ Ø 6 mm

Item no.	Dimension in mm (W)
03.87.401	50
03.87.402	100
03.87.403	150



**Inclined hook
For sockets and socket keys**

■ Ø 6 mm

Item no.	Dimension in mm (W)
03.87.404	14/40



Double tool holder with slanted hook ends

■ Ø 6 mm

Item no.	Dimension in mm (W)
03.87.322	50
03.87.323	75
03.87.324	150



Double tool holder with vertical hook end

■ Ø 6 mm

Item no.	Dimension in mm (W)
03.87.405	35
03.87.406	50
03.87.407	75
03.87.408	150



Pliers holder

Item no.	Dimensions in mm (WxD)
03.87.409	20 x 35
03.87.410	50 x 40
03.87.411	75 x 50
03.87.412	20 x 55
03.87.413	20 x 75



Round holder

Item no.	Dimensions in mm (WxD)
03.87.355	65 x 25



Machine holder

Item no.	Dimensions in mm (Ø)
03.87.357	40
03.87.358	60
03.87.359	80



Base plate for individual solutions

Item no.	Version
03.87.391	Small
03.87.392	Large



Magnetic holder

Item no.	Dimensions in mm (Ø)
03.87.318	40



Magnets

■ 10 pieces

Item no.	Dimensions in mm
03.900.07	Ø 25

Workbench accessories ON THE WORKBENCH

Perforated wall system



Screwdriver holder

- 200/390 x 30 x 40, dimensions in mm (W x D x H)

Item no.	Version
03.87.374	for 6 pieces
03.87.375	for 12 pieces



Drill/hex key holder (various dia.)

- 200/390 x 30 x 35, dimensions in mm (W x D x H)

Item no.	Version
03.87.378	for 14 pieces
03.87.379	for 28 pieces



Bit holder

- for 7 bits

Item no.	Dimensions in mm (WxDxH)
03.87.414	150 x 35 x 10



Hex key holder, Ø 2 – 11 mm

- For 9 hex keys

Item no.	Dimensions in mm (WxDxH)
03.87.377	200 x 25 x 50/70



Tool holder for MT-2 and MT-3

- 395 x 60 x 85, dimensions in mm (W x D x H)

Item no.	Version
03.87.415	MT-2 (15 x Ø 17 mm)
03.87.416	MT-3 (12 x Ø 23 mm)



Socket holder

- For 12 sockets | 9 x Ø 25 mm, 1 x Ø 27 mm, 1 x Ø 32 mm, 1 x Ø 35 mm

Item no.	Dimensions in mm (WxDxH)
03.87.380	390 x 45 x 30



Vertical spanner holder

- For 10 spanners

Item no.	Dimensions in mm (WxDxH)
03.87.372	145/75 x 50 x 220



Vertical ring spanner holder

- For 10 spanners

Item no.	Dimensions in mm (WxDxH)
03.87.417	225/25 x 50 x 255



Horizontal spanner holder

- For 8 spanners

Item no.	Dimensions in mm (WxDxH)
03.87.371	130/60 x 150 x 50



Tube holder, 3 tubes

Item no.	Dimensions in mm (WxDxH)
03.87.418	150 x 85 x 400



Combination holder, 2 parts

Item no.	Dimensions in mm (WxD)
03.87.368	55 x 150



Spool holder up to axial dimension 17 mm

- Maximum width 78 mm

Item no.	Dimensions in mm (Ø)
03.87.419	17



Tool clamp, single, small base plate

Item no.	Dimensions in mm (Ø)
03.87.331	6
03.87.332	10
03.87.333	13
03.87.334	16
03.87.335	19



Double tool clamp

Item no.	Dimensions in mm (Ø)
03.87.341	6
03.87.342	10
03.87.343	13
03.87.344	16
03.87.345	19



Tool clamp, single, large base plate

Item no.	Dimensions in mm (Ø)
03.87.305	25
03.87.306	28
03.87.307	32



Tube holder also for hoses, cables, etc.

- Depth 70 mm

Item no.	Dimensions in mm (Ø)
03.87.383	62
03.87.384	100



Tool holder for self-service packs

Item no.	Dimensions in mm (WxD)
03.87.420	30 x 125



Cable holder

- Hook ends 50 mm high

Item no.	Dimensions in mm (WxD)
03.87.421	37 x 100
03.87.325	37 x 150
03.87.326	37 x 200



Tool holder, 3 tools

Item no.	Dimensions in mm (WxD)
03.87.363	45 x 150



Tool holder, 6 tools

Item no.	Dimensions in mm (WxD)
03.87.19	240 x 140



Saw holder

- Please order in pairs

Item no.	Version
03.87.381	For 4 saws



Tool holder box with wooden panel

- For self-drilling

Item no.	Dimensions in mm (WxDxH)
03.87.422	340 x 135 x 55



Tool holder for self-drilling

- Holder: 390 x 58, dimensions in mm (W x D)

Item no.	Version
03.87.423	390 mm



Tool holder for self-drilling

- Holder: 110 x 58, dimensions in mm (W x D)

Item no.	Version
03.87.424	110 mm

Workbench accessories ON THE WORKBENCH

Hook assortment sets



Range of hooks, 10 parts

- 7x tool holder with inclined end
- 2x double tool holder
- 1x tool clamp

Item no.

03.87.395-10

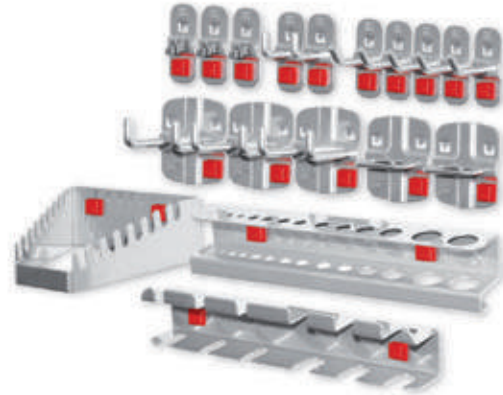

Range of hooks, 18 parts

- 5x tool holder with inclined end
- 2x tool holder with vertical end
- 3x double tool holder
- 3x tool clamp
- 2x pliers holder
- 1x drill holder
- 1x spanner holder
- 1x screwdriver holder

Item no.

03.87.395-18

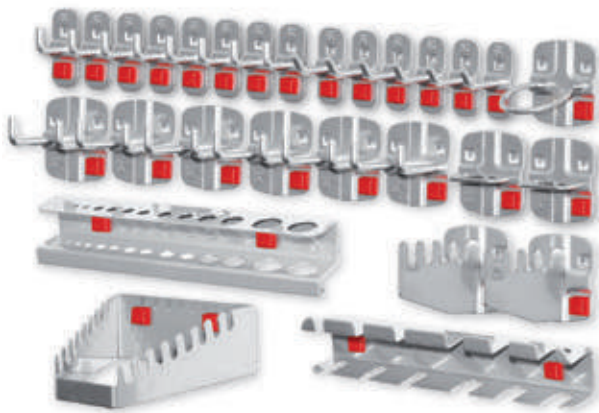

Range of hooks, 28 parts

- 6x tool holder with inclined end
- 8x tool holder with vertical end
- 6x double tool holder
- 2x pliers holder
- 1x machine holder
- 1x spanner holder
- 1x screwdriver holder
- 1x drill holder
- 2x saw holder

Item no.

03.87.395-28

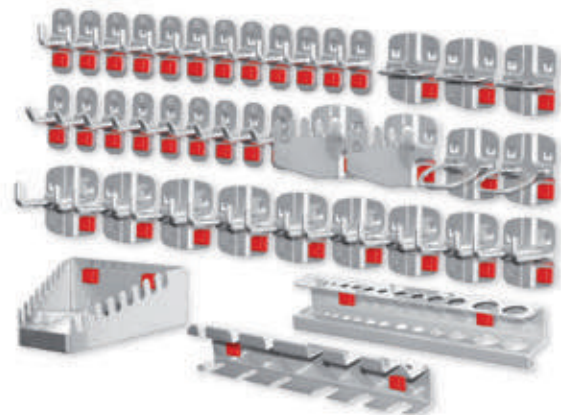

Range of hooks, 40 parts

- 9x tool holder with inclined end
- 12x tool holder with vertical end
- 9x double tool holder
- 3x pliers holder
- 2x machine holder
- 1x spanner holder
- 1x screwdriver holder
- 1x drill holder
- 2x saw holder

Item no.

03.87.395-40

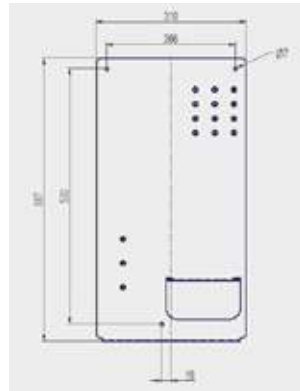

Grease gun holder

- Fastening by wall screw connection e.g. to the perforated wall
- Gun is safely hooked into clamps
- The end of the hose is plugged onto the nipple of the cup to catch dripping grease
- Position of the cup (250 ml) can be individually adjusted to the length of the hose
- The drip tray is located underneath the gun, and is removable and thus facilitates cleaning
- Delivery without grease

Item no.	Dimensions in mm (WxDxH)	Version
03.87.500	310 x 86 x 587	Cartridge Ø 46-56 mm
03.87.501		Cartridge Ø 56-63 mm



Waste bag holder, 2-part

- top 305 x 350 x 130, dimensions in mm (W x D x H)
- bottom 300 x 305 x 120, dimensions in mm (W x D x H)

Item no.
03.87.426

New



Hose holder

- Width 300 mm

Item no.	Dimensions in mm (WxD)
03.87.425	230 x 125



Storage box

Item no.	Dimensions in mm (WxD)
03.87.486	267 x 120 x 120



Roll holder

Item no.	Dimensions in mm
03.900.42	200 x 95 x 71



Roll-off holder

- Min. core dia. 22 mm
- Max. roll width 295 mm

Item no.	Dimensions in mm (WxDxH)
03.87.350	355 x 100 x 120



Bag holder

Item no.	Dimensions in mm
03.900.41	40 x 30 x 70



Workbench accessories ON THE WORKBENCH

Range of hooks for perforated wall systems



Storage shelf

Item no.	Dimensions in mm (WxD)
03.87.427	350 x 125
03.87.428	445 x 150



Depositing box, large

Item no.	Dimensions in mm (WxDxH)
03.87.429	340 x 135 x 55



Depositing box, small

Item no.	Dimensions in mm (WxDxH)
03.87.430	250 x 80 x 35



Steel shelf/tray

Item no.	Dimensions in mm (WxD)
03.87.327	435 x 250



Steel shelf with roll-off edge

Item no.	Dimensions in mm (WxD)
03.87.431	490 x 243



Bottle holder for mounting on the perforated wall

Item no.	Dimensions in mm
03.900.43	Ø 90



Spray bottle holder, single

- Width 76 mm

Item no.	Dimensions in mm (Ø)
03.87.432	52



Can holder, single

- Width 100 mm

Item no.	Dimensions in mm (Ø)
03.87.369	70



Can holder, triple

- Width 300 mm

Item no.	Dimensions in mm (Ø)
03.87.370	70



DIN A5 brochure holder

Item no.	Dimensions in mm (W x H)
03.87.433	150 x 230



DIN A4 brochure holder

Item no.	Dimensions in mm (W x H)
03.87.398	220 x 330



DIN A3 brochure holder

Item no.	Dimensions in mm (W x H)
03.87.434	440 x 330



Folder holder

Item no.	Dimensions in mm (WxDxH)
03.87.435	85 x 220 x 310



Document tray

Item no.	Dimensions in mm (WxDxH)
03.87.436	225 x 310 x 85



Folder holder, for hanging on the perforated wall

Item no.	Dimensions in mm
03.900.025	464 x 300 x 356



Cup holder

- Width 850 mm

Item no.
2494



Pen holder, 4 pens

- Width 112 mm

Item no.	Dimensions in mm (Ø)
03.87.437	17



Pencil cup

- Perforation compatible with tool holder

Item no.	Dimensions in mm (WxDxH)
03.87.438	63 x 70 x 110



workraster - the structured one

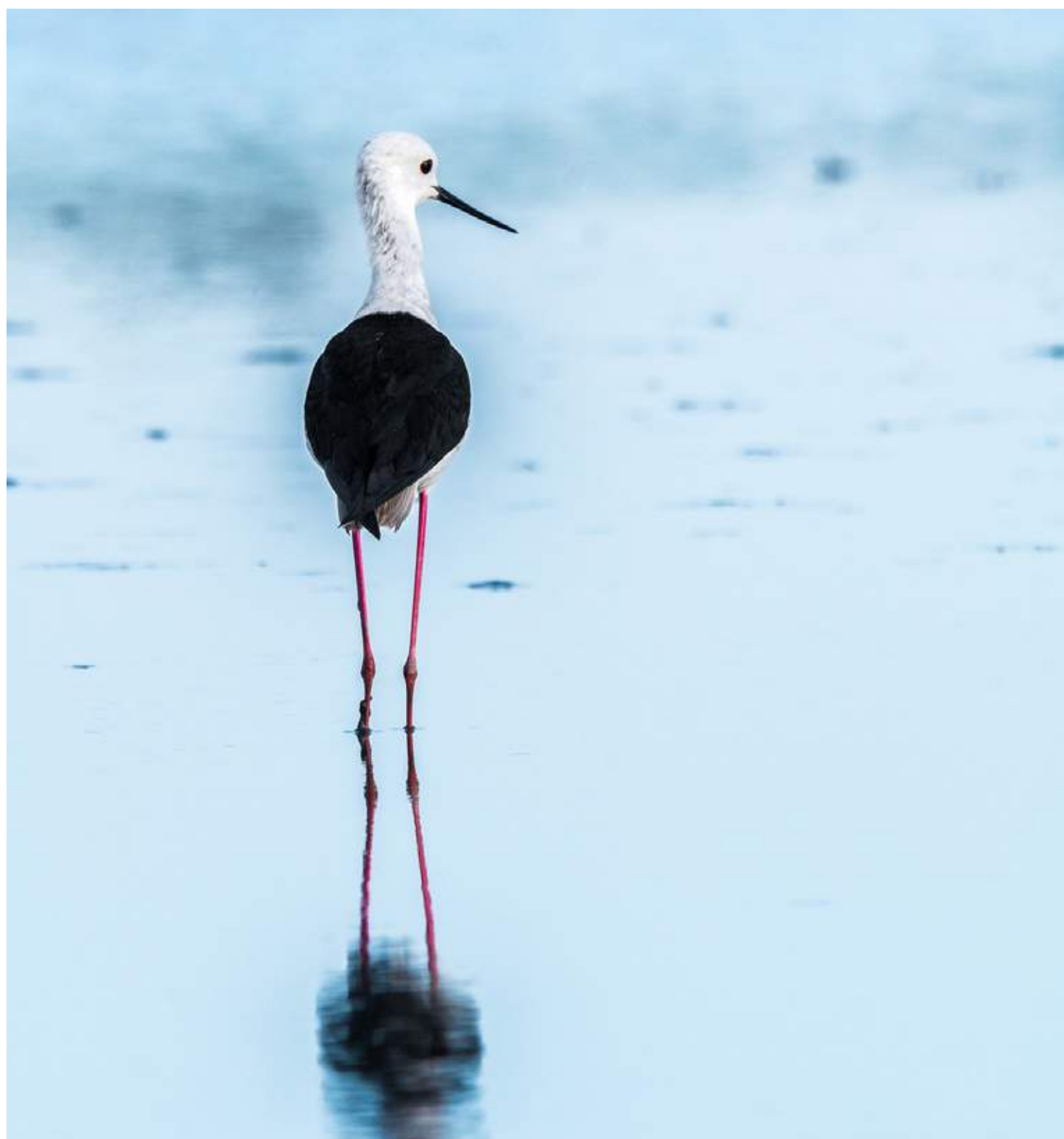



workraster and linkage

Page 319



workraster Combinations from practice

Page 324

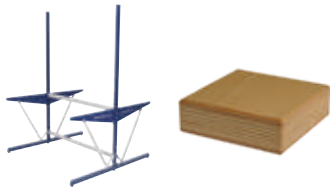

workraster Basic modules and worktops

Page 326



workraster Accessories

Page 328





workraster - the structured one

The **workraster** is the "entry-level model" among our ergonomic workplace systems. Thanks to a structured grid arrangement of 38 mm, the work bench can be individually set to your required height and is therefore suitable for both sitting and standing activities. In particular due to the linkage with roller and small roller conveyors, this system is ideal for a smooth production flow. Thanks to its remarkable flexibility in terms of form, additional modules can be added to the basic work benches at any time. Double-sided workstations are also no problem. With a load capacity of 300 kg with an even load, it is ideal for the assembly of small to medium-sized parts.



i Please note that workraster tables are delivered unassembled. Easy self-assembly!

Our features at a glance	
Basic module models	Single or double for double-sided workplace design
Modular system	Basic modules are connected to each other by means of cross-members - no need for add-on modules
Retrofittable	Extension of existing workstations, inline and corner combinations possible
Energy	Direct supply of lighting, energy, compressed air
Frame widths	1000, 1500 mm
Frame depths	500, 800, 960, 1460 mm
Frame heights	1348, 2070 mm
Work height without worktop	715 – 1057 mm with adjustable support Recommended: 829 mm
Height adjustment	Height grid arrangement of 38 mm
Frame design	L-foot
Load capacity	300 kg with even load

FRAME DESIGN:

WR
E
Single-sided



VWR
D
Double-sided



HEIGHT ADJUSTMENT:

kg
300



Grid adjustment

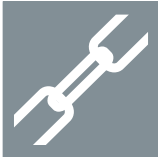

The linkage concept optimises productivity thanks to the arrangement of workstations according to the work sequence

Production - Assembly - Inspection - Packaging. Intermediate transport is avoided, distances are reduced and the working cycle is increased.

The workraster system is among the most efficient systems on the market. Due to the use of standard modules, workstations are interlinked, thus optimising the production flow.

All modules are height-adjustable!

Transport path

The workpiece carriers are transported on the roller conveyors. The path is created by a string of modules.

Linking workstations

The assembly line starts with a basic table with a roller or small roller conveyor. The consecutive conveyors are supplemented by add-on tables or interim connections (labelled as ZM). A basic table with a roller ball or small roller conveyor follows each roller ball/intersecting bridge.

Linking

The workstations are connected using connection, linear or corner modules. Module lengths: 1000 and 1500 mm.

Workstations

The workstations are generally basic tables. With **workline**, they can either feature a roller ball board (for directly passing on the workpiece) or a worktop. With **workraster**, the worktop is combined with the conveyor.

Change of direction

The direction of the workpiece carriers is changed by means of roller ball/intersecting bridge.

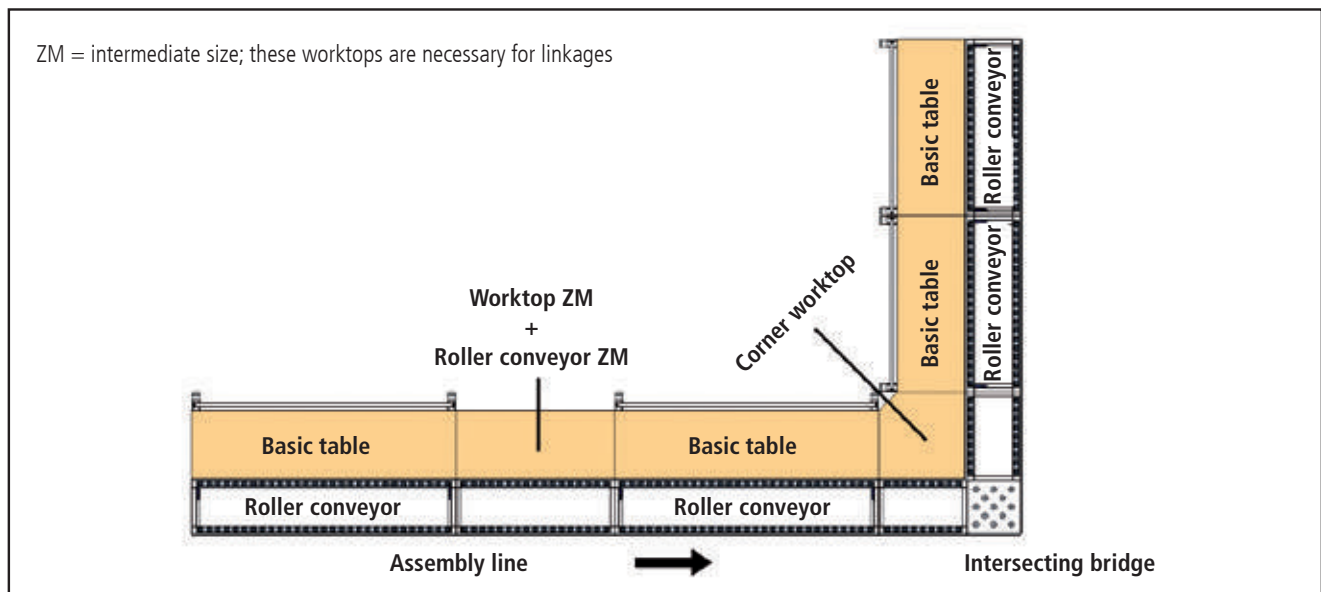

Cross combination

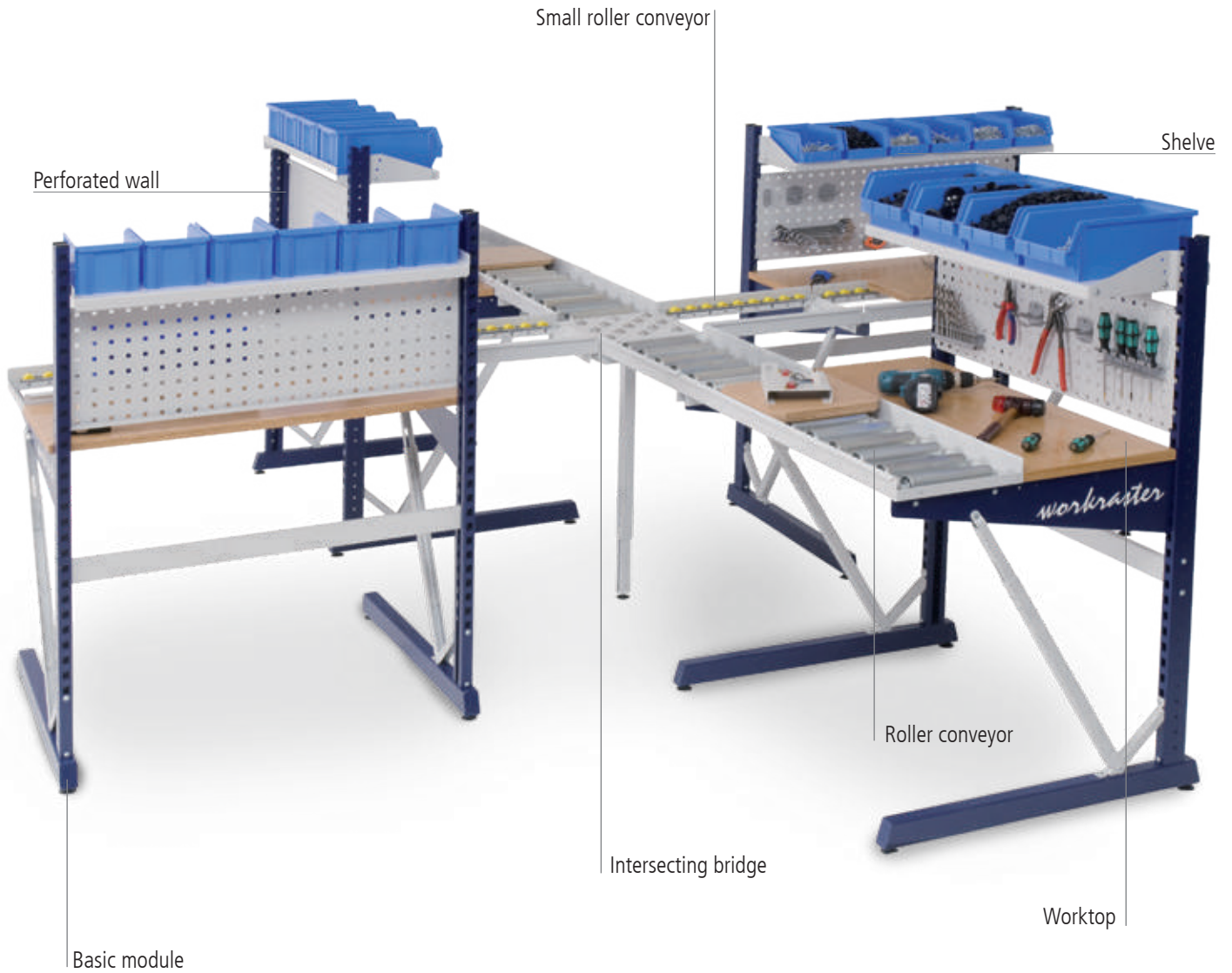

Cross combination

The basic modules are arranged according to the intended application. The various components can be individually combined, linked and arranged in a simple modular system. Working height and handling areas are adapted on site.

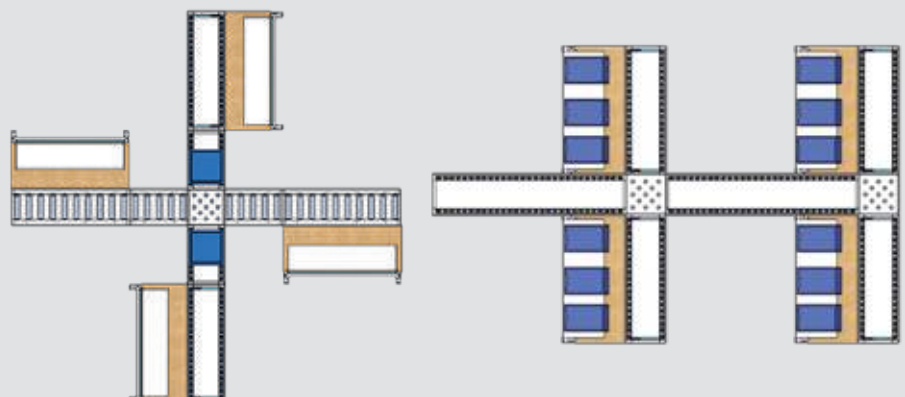

Assembly line

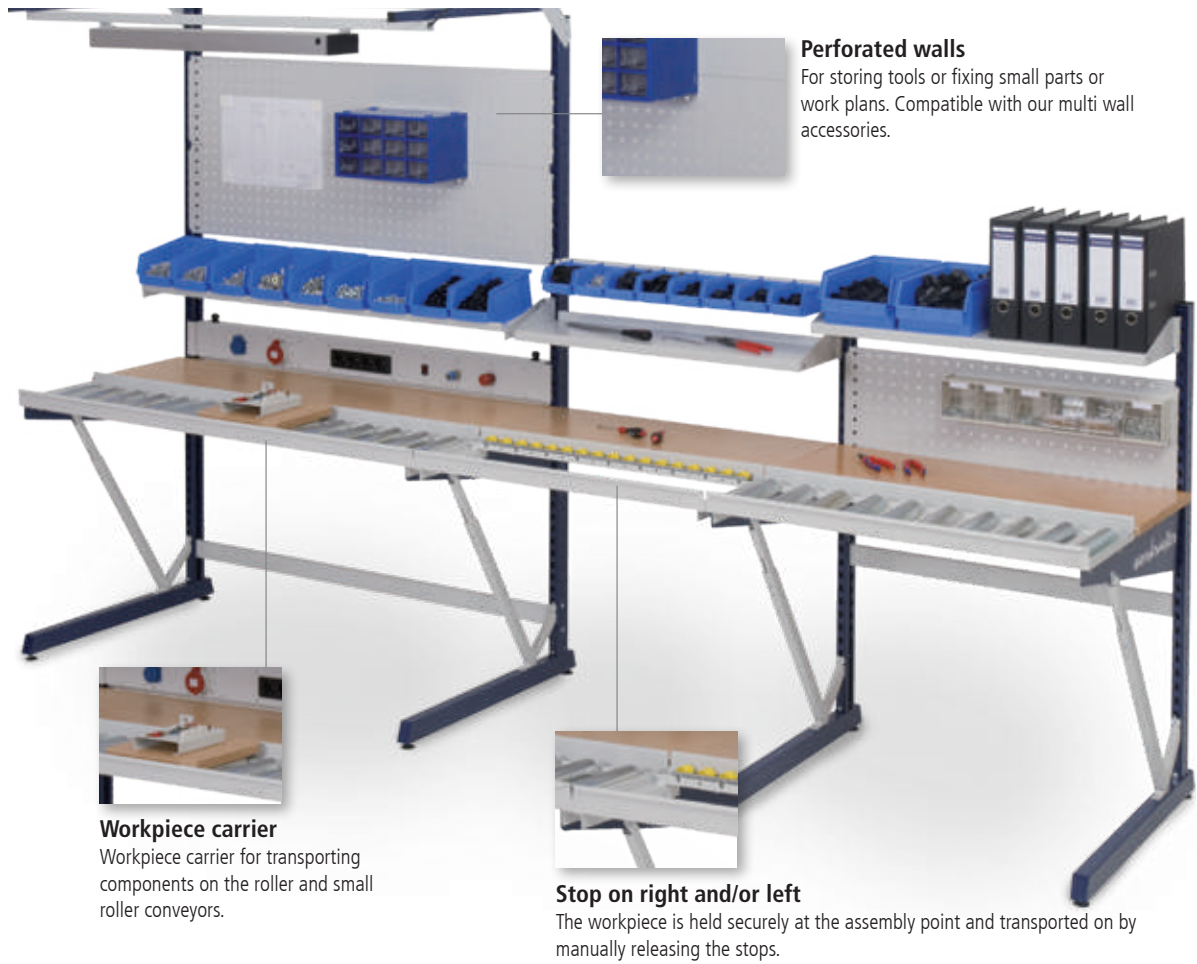

Perforated walls
For storing tools or fixing small parts or work plans. Compatible with our multi wall accessories.

Workpiece carrier
Workpiece carrier for transporting components on the roller and small roller conveyors.

Stop on right and/or left
The workpiece is held securely at the assembly point and transported on by manually releasing the stops.

Arrangement variant Double basic module



Raster column
Shelves or worktops can be individually suspended from the grid columns, each of which can be adjusted in a 38 mm grid.

Corner combination



Shelves, adjustable incline

The shelves have a raised edge and are simply suspended in the perforated holes in the support columns. Their height and incline can be adjusted. Incline: 0°, 10°, 20°.

Hanging drawer

Lockable drawer with front height of 100 mm. It is secured under the worktop.

Module arrangement



PC support A

Is screwed onto the support column of the **workraster** basic module from the inside or outside. Special bracket on the base frame for Construction.



Combinations from practice

- Figure: RAL 5013 Cobalt blue/RAL 7035 Light grey
- Height grid arrangement of 38 mm, individually height-adjustable, therefore ideal for standing and sitting activities
- Modular system: Diverse combination options, including for retrofitting
- The load capacity of the individual basic modules is up to 300 kg with an even load
- Load capacity of the drawer 35 kg
- Direct supply of lighting; electricity and compressed air supplied via energy ducts
- Beech multiplex worktop, 1500 x 750 x 25 mm



workraster with multi-board setup

- 1x overhead frame
- 1x equipment rail
- 1 x LED illumination 28.9 W, 1290 lx

Item no.	Dimensions in mm (WxDxH)
07.899.00	1500 x 800 x 2070



workraster with multi-board setup

- 1x energy bar with 4x earthed sockets
- 2x perforated wall
- 1x shelf, 320 mm
- 1x overhead frame
- 1x equipment rail
- 1 x LED illumination 28.9 W, 1290 lx

Item no.	Dimensions in mm (WxDxH)
07.899.01	1500 x 800 x 2070



workraster with multi-board setup

- 3x perforated wall
- 1x energy bar with 4x earthed sockets and 2x compressed air 1/4"
- 1x overhead frame
- 1x equipment rail
- 1 x LED illumination 28.9 W, 1290 lx
- 1x drawer, 100 mm

Item no.	Dimensions in mm (WxDxH)
07.899.04	1500 x 800 x 2070



workraster with multi-board setup

- 2x perforated wall
- 1x shelf, 320 mm
- 1x energy bar with 2x 4x earthed sockets and 1x compressed air 1/4"
- 1x overhead frame
- 1x equipment rail
- 1 x LED illumination 28.9 W, 1290 lx
- 1x drawer, 100 mm

Item no.	Dimensions in mm (WxDxH)
07.899.05	1500 x 800 x 2070

Supplied without boxes, hooks and tools



workraster with multi-board setup

- 2x shelf, 220 mm
- 2x shelf, 320 mm
- 1x overhead frame
- 1x equipment rail
- 1 x LED illumination 28.9 W, 1290 lx
- 1x drawer, 100 mm

Item no.	Dimensions in mm (WxDxH)
07.899.02	1500 x 800 x 2070



workraster with multi-board setup

- 2x perforated wall
- 2x shelf, 320 mm
- 1x overhead frame
- 1x equipment rail
- 1 x LED illumination 28.9 W, 1290 lx

Item no.	Dimensions in mm (WxDxH)
07.899.06	1500 x 800 x 2070



workraster with multi-board setup

- 1x magnetic wall
- 2x shelf, 220 mm
- 1x energy bar with 2x earthed socket and 2x compressed air 1/4"
- 1x overhead frame
- 1x equipment rail
- 1 x LED illumination 28.9 W, 1290 lx
- 1x drawer, 100 mm

Item no.	Dimensions in mm (WxDxH)
07.899.03	1500 x 800 x 2070



workraster with multi-board setup

- 3x shelf, 220, 320 and 420 mm
- 1x energy bar with 2x earthed socket and 1x compressed air 1/4"
- 1x overhead frame
- 1x equipment rail
- 1 x LED illumination 28.9 W, 1290 lx
- 1x drawer, 100 mm

Item no.	Dimensions in mm (WxDxH)
07.899.07	1500 x 800 x 2070

Supplied without boxes, hooks and tools





Single-sided basic module

- 2x base frame each
- Support columns
- Cross-members, junction plates, supports and worktop carriers
- For worktops with 750 mm depth

Item no.	Dimensions in mm (WxDxH)
07.8410.811	1000 x 800 x 1348
07.8410.821	1000 x 800 x 2070
07.8415.811	1500 x 800 x 1348
07.8415.821	1500 x 800 x 2070



Single-sided basic module, short

- 2x base frame each
- Support columns
- Cross-members, junction plates, supports and worktop carriers
- For worktops with 600 mm depth

Item no.	Dimensions in mm (WxDxH)
07.8410.511	1000 x 550 x 1348
07.8410.521	1000 x 550 x 2070
07.8415.511	1500 x 550 x 1348
07.8415.521	1500 x 550 x 2070



Double-sided basic module

- 2x base frame each
- Support columns
- Cross-members, Junction plates, supports and worktop carriers
- For worktops with 750 mm depth

Item no.	Dimensions in mm (WxDxH)
07.8410.112	1000 x 1460 x 1348
07.8410.122	1000 x 1460 x 2070
07.8415.112	1500 x 1460 x 1348
07.8415.122	1500 x 1460 x 2070



Double-sided basic module, short

- 2x base frame each
- Support columns
- Cross-members, Junction plates, supports and worktop carriers
- For worktops with 600 mm depth

Item no.	Dimensions in mm (WxDxH)
07.8410.912	1000 x 960 x 1348
07.8410.922	1000 x 960 x 2070
07.8415.912	1500 x 960 x 1348
07.8415.922	1500 x 960 x 2070

25 mm worktops

- Worktops with worktop frame for attachment to the basic module, incl. worktop frame

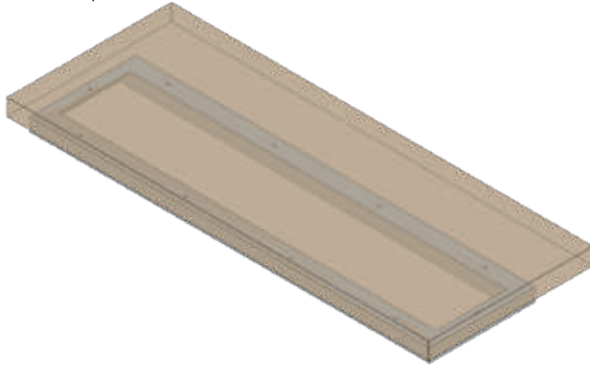

40 mm worktops

- Worktops with worktop bracket for attachment to the basic module, incl. worktop bracket

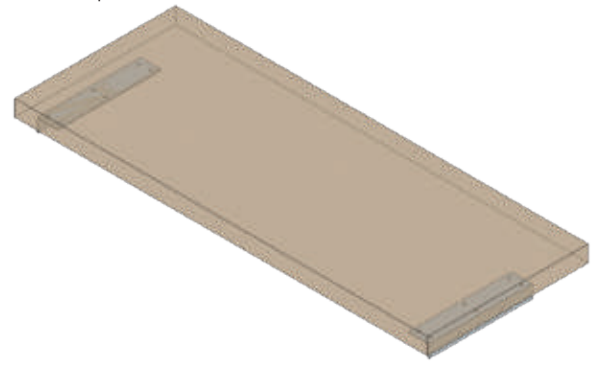

Beech multiplex

- Waterproof
- Dampened according to DIN 68705

Panel thickness	25 mm	40 mm
Dimensions in mm (WxD)	Item no.	Item no.
1500 x 600	07.8115.62	07.8115.64
1400 x 600 ZM*	07.8114.62	07.8114.64
1000 x 600	07.8110.62	07.8110.64
900 x 600 ZM*	07.8109.62	07.8109.64
1500 x 750	07.8115.72	07.8115.74
1400 x 750 ZM*	07.8114.72	07.8114.74
1000 x 750	07.8110.72	07.8110.74
900 x 750 ZM*	07.8109.72	07.8109.74



Chipboard panel directly coated with melamine resin

- 4-sided, ABS edging
- Chipboard carrier panel with laminate coating
- Abrasion-resistant and easy to care for surface

Panel thickness	28 mm	40 mm
Dimensions in mm (WxD)	Item no.	Item no.
1500 x 600	07.8115.62M	07.8115.64M
1400 x 600 ZM*	07.8114.62M	07.8114.64M
1000 x 600	07.8110.62M	07.8110.64M
900 x 600 ZM*	07.8109.62M	07.8109.64M
1500 x 750	07.8115.72M	07.8115.74M
1400 x 750 ZM*	07.8114.72M	07.8114.74M
1000 x 750	07.8110.72M	07.8110.74M
900 x 750 ZM*	07.8109.72M	07.8109.74M



MDF worktop with 0.7 mm HPL coat

- With 0.7 mm HPL coat
- Highly abrasion-resistant
- 4-sided, ABS edging

Panel thickness	30 mm	40 mm
Dimensions in mm (WxD)	Item no.	Item no.
1500 x 600	07.8115.62H	07.8115.64H
1400 x 600 ZM*	07.8114.62H	07.8114.64H
1000 x 600	07.8110.62H	07.8110.64H
900 x 600 ZM*	07.8109.62H	07.8109.64H
1500 x 750	07.8115.72H	07.8115.74H
1400 x 750 ZM*	07.8114.72H	07.8114.74H
1000 x 750	07.8110.72H	07.8110.74H
900 x 750 ZM*	07.8109.72H	07.8109.74H



ESD conductive workbench top

- Suitable for all electrostatically sensitive areas
- Surface RAL 7035

Panel thickness	30 mm	40 mm
Dimensions in mm (WxD)	Item no.	Item no.
1500 x 600	07.8115.62E	07.8115.64E
1400 x 600 ZM*	07.8114.62E	07.8114.64E
1000 x 600	07.8110.62E	07.8110.64E
900 x 600 ZM*	07.8109.62E	07.8109.64E
1500 x 750	07.8115.72E	07.8115.74E
1400 x 750 ZM*	07.8114.72E	07.8114.74E
1000 x 750	07.8110.72E	07.8110.74E
900 x 750 ZM*	07.8109.72E	07.8109.74E

Other versions on request

*ZM = intermediate size. These worktops are necessary for linkages. e.g. 2x basic table and 1x ZM, 3x basic table and 2x ZM



You can find further accessories on/from page 236



Intersecting bridge

- Includes 4 end stops

Item no.	Length in mm
07.8830.300	300 x 300
07.8840.400	400 x 400
07.8830.400	300 x 400



Support foot

- Height-adjustable

Item no.	Dimensions in mm (WxDxH)	Design
07.89.42	550 x 1348	Left
07.89.45		Right



Corner panel support

- Height-adjustable

Item no.	Dimensions in mm (WxDxH)
07.89.10	150 x 150 x 655 – 1150

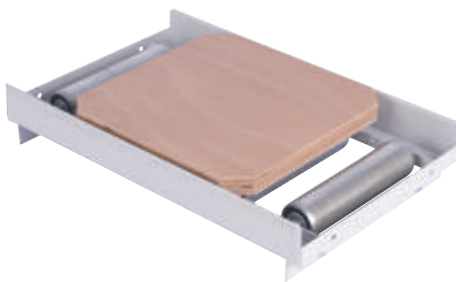

Workpiece carrier for transporting components on the roller and small roller conveyors

Item no.	Dimensions in mm (WxDxH)	For roller/small roller conveyor width in mm
07.89.40	294 x 294 x 25	300
07.89.41	394 x 394 x 25	400
07.89.43	294 x 294 x 40	300

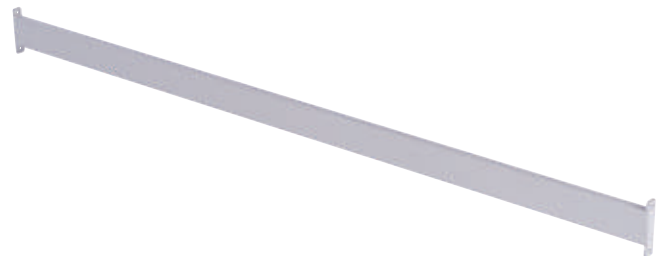

Cross-member for linking basic modules

Item no.	Length in mm
07.89.17	1000
07.89.16	1500



PC support A

- For side attachment
- 205 x 550 x 500 mm

Item no.	Design
07.89.07	Right
07.89.08	Left



Hanging drawer block

- Front height 100 mm
- Drawers with full pull-out (FP) 100%
- Load capacity 35 kg

Item no.	Dimensions in mm (WxDxH)
07.18.01	365 x 400 x 140



Stopper

- Supplied in pairs

Item no.	Dimensions in mm (WxDxH)
07.81.02	182 x 8 x 30



End stop

Item no.	Length in mm
07.8904.300	300
07.8904.400	400



- Top frame with bolted stiffening crossbar.
- For attaching the lighting and for holding the glider

Item no.	Design	Dimensions in mm (WxD)
1. 07.8910.1	Overhead frame	1000 x 750
1. 07.8915.1	Overhead frame	1500 x 750
2. 03.910.03	Equipment rail	1000



- Double-sided overhead frame with bolted reinforcement cross-members
- For attaching the lighting and for holding the glider

Item no.	Design	Dimensions in mm (WxDxH)
1. 07.8910.2	Overhead frame	1000 x 750
1. 07.8915.2	Overhead frame	1500 x 750
2. 03.915.03	Equipment rail	1500

WORKTOP
DEPTH 390 MM



ROLLER CONVEYOR
DEPTH 300 / 400 MM





Beech multiplex

- Waterproof
- Dampened according to DIN 68705

Panel thickness	25 mm	40 mm
Dimensions in mm (WxD)	Item no.	Item no.
1500 x 390	07.8115.32	07.8115.34
1400 x 390 ZM*	07.8114.32	07.8114.34
1000 x 390	07.8110.32	07.8110.34
900 x 390 ZM*	07.8109.32	07.8109.34

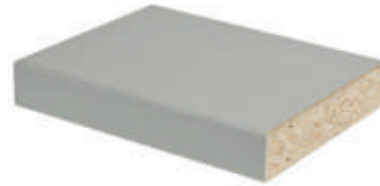

Chipboard panel directly coated with melamine resin

- 4-sided, ABS edging
- Chipboard carrier panel with laminate coating
- Abrasion-resistant and easy to care for surface

Panel thickness	28 mm	40 mm
Dimensions in mm (WxD)	Item no.	Item no.
1500 x 390	07.8115.32M	07.8115.34M
1400 x 390 ZM*	07.8114.32M	07.8114.34M
1000 x 390	07.8110.32M	07.8110.34M
900 x 390 ZM*	07.8109.32M	07.8109.34M

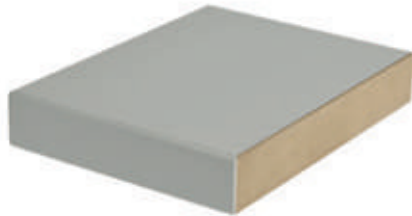

MDF worktop with 0.7 mm HPL coat

- Highly abrasion-resistant
- 4-sided, ABS edging

Panel thickness	30 mm	40 mm
Dimensions in mm (WxD)	Item no.	Item no.
1500 x 390	07.8115.32H	07.8115.34H
1400 x 390 ZM*	07.8114.32H	07.8114.34H
1000 x 390	07.8110.32H	07.8110.34H
900 x 390 ZM*	07.8109.32H	07.8109.34H



ESD conductive workbench top

- Suitable for all electrostatically sensitive areas
- Surface RAL 7035

Panel thickness	30 mm	40 mm
Dimensions in mm (WxD)	Item no.	Item no.
1500 x 390	07.8115.32E	07.8115.34E
1400 x 390 ZM*	07.8114.32E	07.8114.34E
1000 x 390	07.8110.32E	07.8110.34E
900 x 390 ZM*	07.8109.32E	07.8109.34E



Roller conveyor

Depth	300 mm	400 mm
Length in mm	Item no.	Item no.
1500	07.8715.300	07.8715.400
1400 ZM*	07.8714.300	07.8714.400
1000	07.8710.300	07.8710.400
900 ZM*	07.8790.300	07.8790.400
500	07.8750.300	07.8750.400

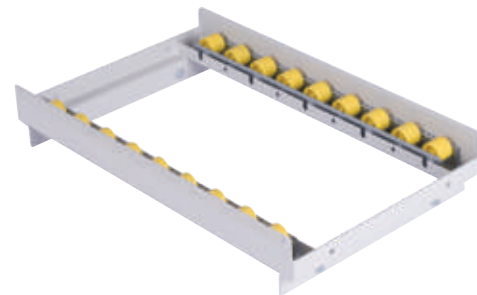

Small roller conveyor

Depth	300 mm	400 mm
Length in mm	Item no.	Item no.
1500	07.8615.300	07.8615.400
1400 ZM*	07.8614.300	07.8614.400
1000	07.8610.300	07.8610.400
900 ZM*	07.8690.300	07.8690.400
500	07.8650.300	07.8650.400

*ZM = intermediate size. These worktops are necessary for linkages. e.g. 2x basic table and 1x ZM, 3x basic table and 2x ZM



1 | Corner panels

Corner worktops with worktop bracket for table-to-table connection



2 | Corner trapezoidal panels

Corner worktops with worktop bracket for table-to-table connection



1

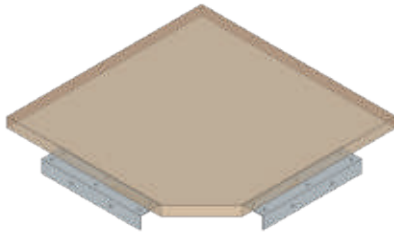

2

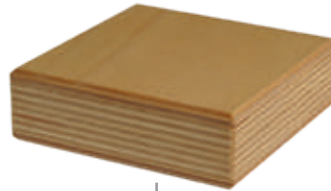
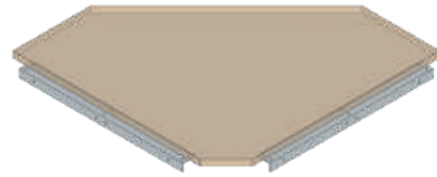

Beech multiplex

- Waterproof
- Dampened according to DIN 68705

Item no.	Dimensions in mm (WxDxH)
07.8130.40	494 x 494 x 40
07.8140.40	394 x 394 x 40
07.8130.25	494 x 494 x 25
07.8140.25	394 x 394 x 25

Item no.	Dimensions in mm (WxDxH)
07.8175.40	854 x 854 x 40
07.8175.25	854 x 854 x 25

Chipboard panel directly coated with melamine resin

- 4-sided, ABS edging
- Chipboard carrier panel with laminate coating
- Abrasion-resistant and easy to care for surface



Item no.	Dimensions in mm (WxDxH)
07.8130.40M	494 x 494 x 40
07.8140.40M	394 x 394 x 40
07.8130.25M	494 x 494 x 25
07.8140.25M	394 x 394 x 25

Item no.	Dimensions in mm (WxDxH)
07.8175.40M	854 x 854 x 40
07.8175.25M	854 x 854 x 25

MDF worktop with 0.7 mm HPL coat

- Highly abrasion-resistant
- 4-sided, ABS edging

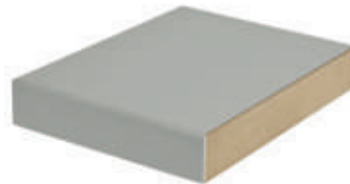

Item no.	Dimensions in mm (WxDxH)
07.8130.40H	494 x 494 x 40
07.8140.40H	394 x 394 x 40
07.8130.25H	494 x 494 x 25
07.8140.25H	394 x 394 x 25

Item no.	Dimensions in mm (WxDxH)
07.8175.40H	854 x 854 x 40
07.8175.25H	854 x 854 x 25

ESD conductive workbench top

- Suitable for all electrostatically sensitive areas
- Surface RAL 7035



Item no.	Dimensions in mm (WxDxH)
07.8130.40E	494 x 494 x 40
07.8140.40E	394 x 394 x 40
07.8130.25E	494 x 494 x 25
07.8140.25E	394 x 394 x 25

Item no.	Dimensions in mm (WxDxH)
07.8175.40E	854 x 854 x 40
07.8175.25E	854 x 854 x 25



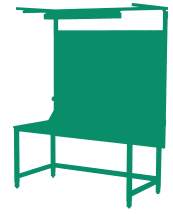

workergo - the versatile one





workergo C-foot linkages

Seite 336



workergo C-foot basic frames

Seite 340



workergo 4-foot linkages

Seite 342



workergo 4-foot basic frames

Seite 346

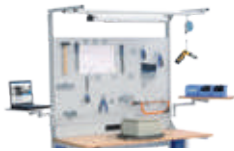

Multi-board setup

Seite 350



workergo base cabinets

Seite 352



workergo corner panels

Seite 354



C-foot tables



C-foot basic frame

New
Now even faster
and quieter!

workergo - the versatile one

The **workergo** is the most versatile workplace systems. Six different frame widths, two different frame depths and four different types of height adjustment make the workergo C-foot a versatile worktable.

- Standard colours: RAL 7035 Light grey/RAL 5012 Light blue
- Base frame made of 45 x 45 mm steel tube
- Cross-members made of 40 x 40 mm aluminium sections



Please note that workergo tables are delivered unassembled. Easy self-assembly!



Our features at a glance

Modular system	Freely selectable combinations from frame to worktop
Retrofittable	Multi-board setup and optional accessories
Energy	Direct supply of lighting, energy, compressed air
Frame widths	750, 1000, 1250, 1500, 1750 and 2000 mm
Frame depths	600, 750 mm
Travel speed	12 mm/s
Work height without worktop	670 – 1015 mm Vertical travel: 345 mm
Height adjustment	Four different types: Clamp fixing, crank adjustment, electric height adjustment with 1 motor, electric height adjustment with 2 motors
Frame design	C-foot
Load capacity	180-300 kg with uniform load depending on height adjustment

FRAME DESIGN



C-foot



Basic table

HEIGHT ADJUSTMENT:

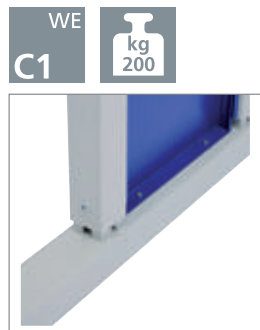

Clamp fixing



Crank adjustment



Electric height adjustment,
1 motor



Electric height adjustment,
2 motors



C-foot linkage variants



Cascading

- Cascading is required to adjust the height of several tables synchronously
- Linking up to 5 basic tables

Item no.	Description
4CKAS1-2	Y-connector for cascading 2 basic tables
4CKAS3-6	Lifting element for cascading 3 to 5 basic tables
4CKASVERB	Connecting element absolutely necessary for each individual basic table

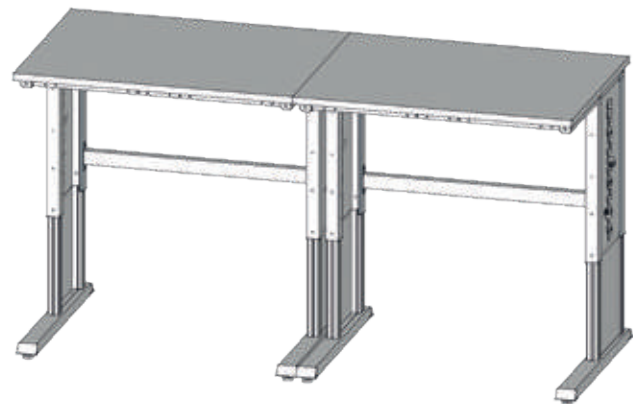

Linkage consisting of two basic tables with multi-board setup and corner panel

C-foot linkage variants



Linkage consisting of two basic tables and two multi-board setups

Individual cover panel labelling on request





Available in new widths

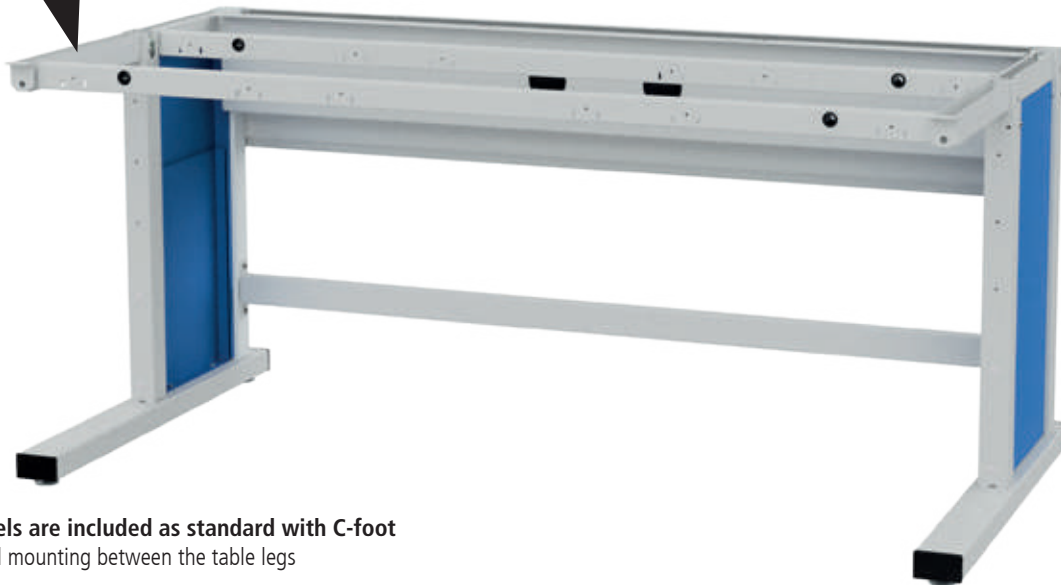

Cover panels are included as standard with C-foot

- For lateral mounting between the table legs



CLAMP FIXING - STANDARD



Item no.	Dimensions in mm (W x D x H)
C075KL60G	750 x 600 x 670 - 1015
C100KL60G	1000 x 600 x 670 - 1015
C125KL60G	1250 x 600 x 670 - 1015
C150KL60G	1500 x 600 x 670 - 1015
C175KL60G	1750 x 600 x 670 - 1015
C200KL60G	2000 x 600 x 670 - 1015
C075KL75G	750 x 750 x 670 - 1015
C100KL75G	1000 x 750 x 670 - 1015
C125KL75G	1250 x 750 x 670 - 1015
C150KL75G	1500 x 750 x 670 - 1015
C175KL75G	1750 x 750 x 670 - 1015
C200KL75G	2000 x 750 x 670 - 1015

CRANK ADJUSTMENT



Item no.	Dimensions in mm (W x D x H)
C075KU60G	750 x 600 x 670 - 1015
C100KU60G	1000 x 600 x 670 - 1015
C125KU60G	1250 x 600 x 670 - 1015
C150KU60G	1500 x 600 x 670 - 1015
C175KU60G	1750 x 600 x 670 - 1015
C200KU60G	2000 x 600 x 670 - 1015
C075KU75G	750 x 750 x 670 - 1015
C100KU75G	1000 x 750 x 670 - 1015
C125KU75G	1250 x 750 x 670 - 1015
C150KU75G	1500 x 750 x 670 - 1015
C175KU75G	1750 x 750 x 670 - 1015
C200KU75G	2000 x 750 x 670 - 1015

C-foot basic frame

You can find further worktops on/from page 422

workergo workplace systems



Beech multiplex worktop

- Glue laminated, oiled
- Waterproof
- Dampened according to DIN 68705

Item no.	Dimensions in mm (W x D x H)
03.1260.25	1250 x 600 x 25
03.1560.25	1500 x 600 x 25
03.2060.25	2000 x 600 x 25
03.125.25	1250 x 750 x 25
03.15.25	1500 x 750 x 25
03.20.25	2000 x 750 x 25

Chipboard worktop with melamine resin coating

- 4-sided, ABS edging
- Chipboard carrier plate with direct coating
- Abrasion-resistant and easy to care for surface

Item no.	Dimensions in mm (W x D x H)
07.M12560.28	1250 x 600 x 28
07.M1560.28	1500 x 600 x 28
07.M2060.28	2000 x 600 x 28
07.M12575.28	1250 x 750 x 28
07.M1575.28	1500 x 750 x 28
07.M2075.28	2000 x 750 x 28

ELECTRIC HEIGHT ADJUSTMENT, 1 MOTOR



- Manual switch "memory"
- Save up to 4 positions
- LCD-Display
- Mounted under the worktop



Item no.	Dimensions in mm (W x D x H)
C075E160G	750 x 600 x 670 - 1015
C100E160G	1000 x 600 x 670 - 1015
C125E160G	1250 x 600 x 670 - 1015
C150E160G	1500 x 600 x 670 - 1015
C175E160G	1750 x 600 x 670 - 1015
C200E160G	2000 x 600 x 670 - 1015
C075E175G	750 x 750 x 670 - 1015
C100E175G	1000 x 750 x 670 - 1015
C125E175G	1250 x 750 x 670 - 1015
C150E175G	1500 x 750 x 670 - 1015
C175E175G	1750 x 750 x 670 - 1015
C200E175G	2000 x 750 x 670 - 1015

ELECTRIC HEIGHT ADJUSTMENT, 2 MOTORS



- Manual switch "memory"
- Save up to 4 positions
- LCD-Display
- Mounted under the worktop



Item no.	Dimensions in mm (W x D x H)
C075E260G	750 x 600 x 670 - 1015
C100E260G	1000 x 600 x 670 - 1015
C125E260G	1250 x 600 x 670 - 1015
C150E260G	1500 x 600 x 670 - 1015
C175E260G	1750 x 600 x 670 - 1015
C200E260G	2000 x 600 x 670 - 1015
C075E275G	750 x 750 x 670 - 1015
C100E275G	1000 x 750 x 670 - 1015
C125E275G	1250 x 750 x 670 - 1015
C150E275G	1500 x 750 x 670 - 1015
C175E275G	1750 x 750 x 670 - 1015
C200E275G	2000 x 750 x 670 - 1015





4-foot tables



4-foot basic frame

New
Now even faster
and quieter!

workergo - the versatile one

The workergo is the most versatile workplace systems. Six different frame widths, three different frame depths and four different types of height adjustment make the workergo 4-foot a versatile work-table.

- Standard colours: RAL 7035 light grey/RAL 5012 light blue
- Base frame made of 45 x 45 mm steel tube
- Cross-members made of 40 x 40 mm aluminium sections



Please note that workergo tables are delivered unassembled. Easy self-assembly!



Our features at a glance

Modular system	Freely selectable combinations from frame to worktop
Retrofittable	Multi-board setup and optional accessories
Energy	Direct supply of lighting, energy, compressed air
Frame widths	750, 1000, 1250, 1500, 1750 and 2000 mm
Frame depths	600, 750, 900 mm
Travel speed	12 mm/s
Work height without worktop	670 – 1015 mm Vertical travel: 345 mm
Height adjustment	Four different types: Clamp fixing, crank adjustment, electric height adjustment with 1 motor, electric height adjustment with 2 motors
Frame design	4-foot
Load capacity	180-300 kg with uniform load depending on height adjustment

FRAME DESIGN:



4-foot



Basic table

HEIGHT ADJUSTMENT:



Clamp fixing



Crank adjustment



Electric height adjustment,
1 motor



Electric height adjustment,
2 motors



4-foot linkage variants



Corner combination with large corner panel comprising two basic tables. Multi-board setup not possible on the corner panel.



Inline combination with two basic tables. Multi-board setup possible on both tables.

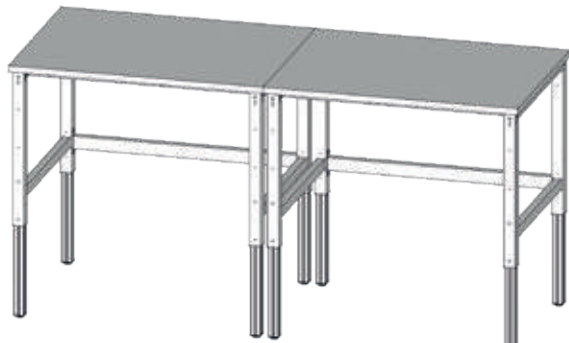

Cascading

- Cascading is required to adjust the height of several tables synchronously
- Linking up to 5 basic tables



Item no.	Description
4CKAS1-2	Y-connector for cascading 2 basic tables
4CKAS3-6	Lifting element for cascading 3 to 5 basic tables
4CKASVERB	Connecting element absolutely necessary for each individual basic table

Ground anchorage

- For fixing the workbench to the floor
- 4 pieces

Item no.
03.00.34



workergo 4-foot - expander casters Ø 100 mm

Item no.	Description
4XXXXXMBL100	2 x fixed caster, 2 x steering caster with lock
4XXXXXMLL100	4 x steering caster, thereof 2 with locks

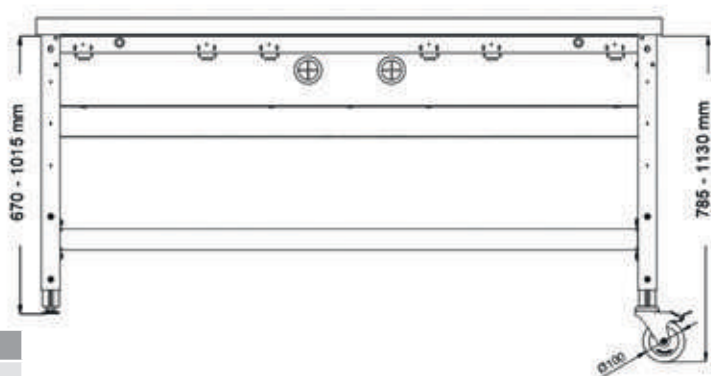



Linkage consisting of two basic tables with multi-board setup on both tables.

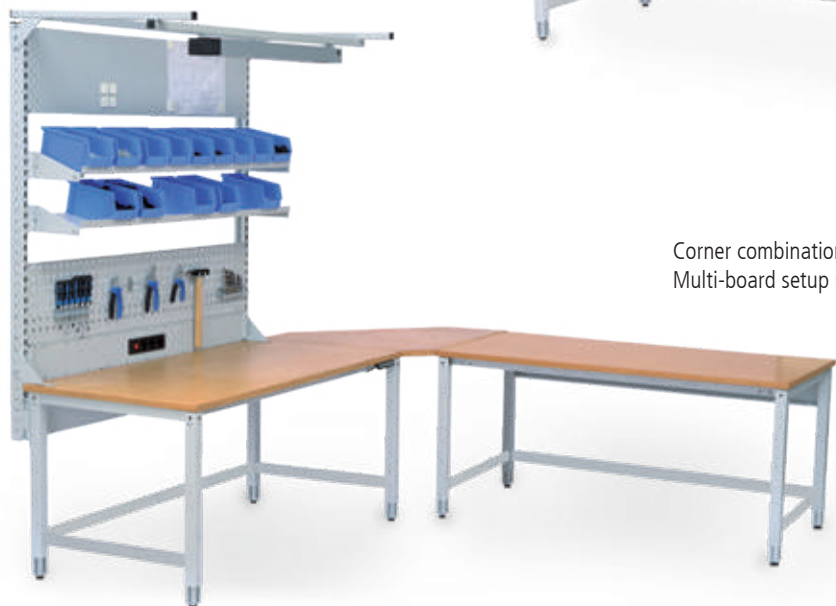

Corner combination with large corner panel comprising two basic tables. Multi-board setup not possible on the corner panel.





Available in new widths



Individual cover panel labelling on page 39

workergo cover panel, 4-foot version

- For lateral mounting between the table legs of 4-foot tables

Item no.	Dimensions in mm (W x D x H)	For depth in mm
4XXXXX60BL	485 x 30 x 571	600
4XXXXX75BL	635 x 30 x 571	750
4XXXXX90BL	785 x 30 x 571	900

CLAMP FIXING - STANDARD



Item no.	Dimensions in mm (W x D x H)
4075KL60G	750 x 600 x 670 - 1015
4100KL60G	1000 x 600 x 670 - 1015
4125KL60G	1250 x 600 x 670 - 1015
4150KL60G	1500 x 600 x 670 - 1015
4175KL60G	1750 x 600 x 670 - 1015
4200KL60G	2000 x 600 x 670 - 1015
4075KL75G	750 x 750 x 670 - 1015
4100KL75G	1000 x 750 x 670 - 1015
4125KL75G	1250 x 750 x 670 - 1015
4150KL75G	1500 x 750 x 670 - 1015
4175KL75G	1750 x 750 x 670 - 1015
4200KL75G	2000 x 750 x 670 - 1015
4075KL90G	750 x 900 x 670 - 1015
4100KL90G	1000 x 900 x 670 - 1015
4125KL90G	1250 x 900 x 670 - 1015
4150KL90G	1500 x 900 x 670 - 1015
4175KL90G	1750 x 900 x 670 - 1015
4200KL90G	2000 x 900 x 670 - 1015

You can find further worktops on/from page 422



Beech multiplex worktop

- Glue laminated, oiled
- Waterproof
- Dampened according to DIN 68705

Item no.	Dimensions in mm (W x D x H)
03.1560.25	1500 x 600 x 25
03.2060.25	2000 x 600 x 25
03.15.25	1500 x 750 x 25
03.20.25	2000 x 750 x 25
03.1590.25	1500 x 900 x 25
03.2090.25	2000 x 900 x 25

Chipboard worktop with melamine resin coating

- 4-sided, ABS edging
- Chipboard carrier plate with direct coating
- Abrasion-resistant and easy to care for surface

Item no.	Dimensions in mm (W x D x H)
07.M1560.28	1500 x 600 x 28
07.M2060.28	2000 x 600 x 28
07.M1575.28	1500 x 750 x 28
07.M2075.28	2000 x 750 x 28
07.M1590.28	1500 x 900 x 28
07.M2090.28	2000 x 900 x 28

CRANK ADJUSTMENT



Item no.	Dimensions in mm (W x D x H)
4075KU60G	750 x 600 x 670 - 1015
4100KU60G	1000 x 600 x 670 - 1015
4125KU60G	1250 x 600 x 670 - 1015
4150KU60G	1500 x 600 x 670 - 1015
4175KU60G	1750 x 600 x 670 - 1015
4200KU60G	2000 x 600 x 670 - 1015
4075KU75G	750 x 750 x 670 - 1015
4100KU75G	1000 x 750 x 670 - 1015
4125KU75G	1250 x 750 x 670 - 1015
4150KU75G	1500 x 750 x 670 - 1015
4175KU75G	1750 x 750 x 670 - 1015
4200KU75G	2000 x 750 x 670 - 1015
4075KU90G	750 x 900 x 670 - 1015
4100KU90G	1000 x 900 x 670 - 1015
4125KU90G	1250 x 900 x 670 - 1015
4150KU90G	1500 x 900 x 670 - 1015
4175KU90G	1750 x 900 x 670 - 1015
4200KU90G	2000 x 900 x 670 - 1015





Available in new widths

WE
V3



ELECTRIC HEIGHT ADJUSTMENT, 1 MOTOR

- Manual switch "memory"
- Save up to 4 positions
- LCD-Display
- Mounted under the worktop



Item no.	Dimensions in mm (W x D x H)
4075E160G	750 x 600 x 670 - 1015
4100E160G	1000 x 600 x 670 - 1015
4125E160G	1250 x 600 x 670 - 1015
4150E160G	1500 x 600 x 670 - 1015
4175E160G	1750 x 600 x 670 - 1015
4200E160G	2000 x 600 x 670 - 1015
4075E175G	750 x 750 x 670 - 1015
4100E175G	1000 x 750 x 670 - 1015
4125E175G	1250 x 750 x 670 - 1015
4150E175G	1500 x 750 x 670 - 1015
4175E175G	1750 x 750 x 670 - 1015
4200E175G	2000 x 750 x 670 - 1015
4075E190G	750 x 900 x 670 - 1015
4100E190G	1000 x 900 x 670 - 1015
4125E190G	1250 x 900 x 670 - 1015
4150E190G	1500 x 900 x 670 - 1015
4175E190G	1750 x 900 x 670 - 1015
4200E190G	2000 x 900 x 670 - 1015

WE
V4



ELECTRIC HEIGHT ADJUSTMENT, 2 MOTORS

- Manual switch "memory"
- Save up to 4 positions
- LCD-Display
- Mounted under the worktop



Item no.	Dimensions in mm (W x D x H)
4075E260G	750 x 600 x 670 - 1015
4100E260G	1000 x 600 x 670 - 1015
4125E260G	1250 x 600 x 670 - 1015
4150E260G	1500 x 600 x 670 - 1015
4175E260G	1750 x 600 x 670 - 1015
4200E260G	2000 x 600 x 670 - 1015
4075E275G	750 x 750 x 670 - 1015
4100E275G	1000 x 750 x 670 - 1015
4125E275G	1250 x 750 x 670 - 1015
4150E275G	1500 x 750 x 670 - 1015
4175E275G	1750 x 750 x 670 - 1015
4200E275G	2000 x 750 x 670 - 1015
4075E290G	750 x 900 x 670 - 1015
4100E290G	1000 x 900 x 670 - 1015
4125E290G	1250 x 900 x 670 - 1015
4150E290G	1500 x 900 x 670 - 1015
4175E290G	1750 x 900 x 670 - 1015
4200E290G	2000 x 900 x 670 - 1015



The equipment rail is mounted on the overhead frame and serves to accommodate the carriage or the lighting.

Item no.	Dimensions in mm (W x H)
03.910.03	1000 x 30 x 30
03.912.03	1250 x 30 x 30
03.915.03	1500 x 30 x 30
03.917.03	1750 x 30 x 30
03.920.03	2000 x 30 x 30
03.900.01	Carriage

You can find further accessories on/from page 284



Overhead frame with bolted reinforcement cross-members

Item no.	Dimensions in mm (W x H)
07.8910.1	1000 x 750
07.8912.1	1250 x 750
07.8915.1	1500 x 750

Overhead frame with bolted reinforcement cross-members

Item no.	Dimensions in mm (W x D)
07.8920.1	2000 x 750



workergo multi-board setup

- 2x support column
- 1x cross-member
- 1x rear wall

Item no.	Dimensions in mm (W x H)
03.10.14.01	1000 x 1491
03.12.14.01	1250 x 1491
03.15.14.01	1500 x 1491

i Three support columns are required for a table width of 2000 mm. The number of perforated walls, magnetic boards and shelves doubles.



workergo multi-board setup

- 3x support column
- 2x cross-member
- 1x rear wall

Item no.	Dimensions in mm (W x H)
03.20.14.01	2000 x 1491



workergo multi-board setup

- Overhead frames with equipment rail and lighting
- 3x support column
- 2x cross-member, 1x rear wall
- 2x magnetic board, 2x perforated wall
- 1x energy bar with 4x earthed sockets
- 2x shelf, 320 mm
- 1x pivot arm with platform, 1x pivot arm with shelf and ribbed rubber mat

Item no.	Dimensions in mm (W x H)
03.20.14.01-1	2000 x 1491



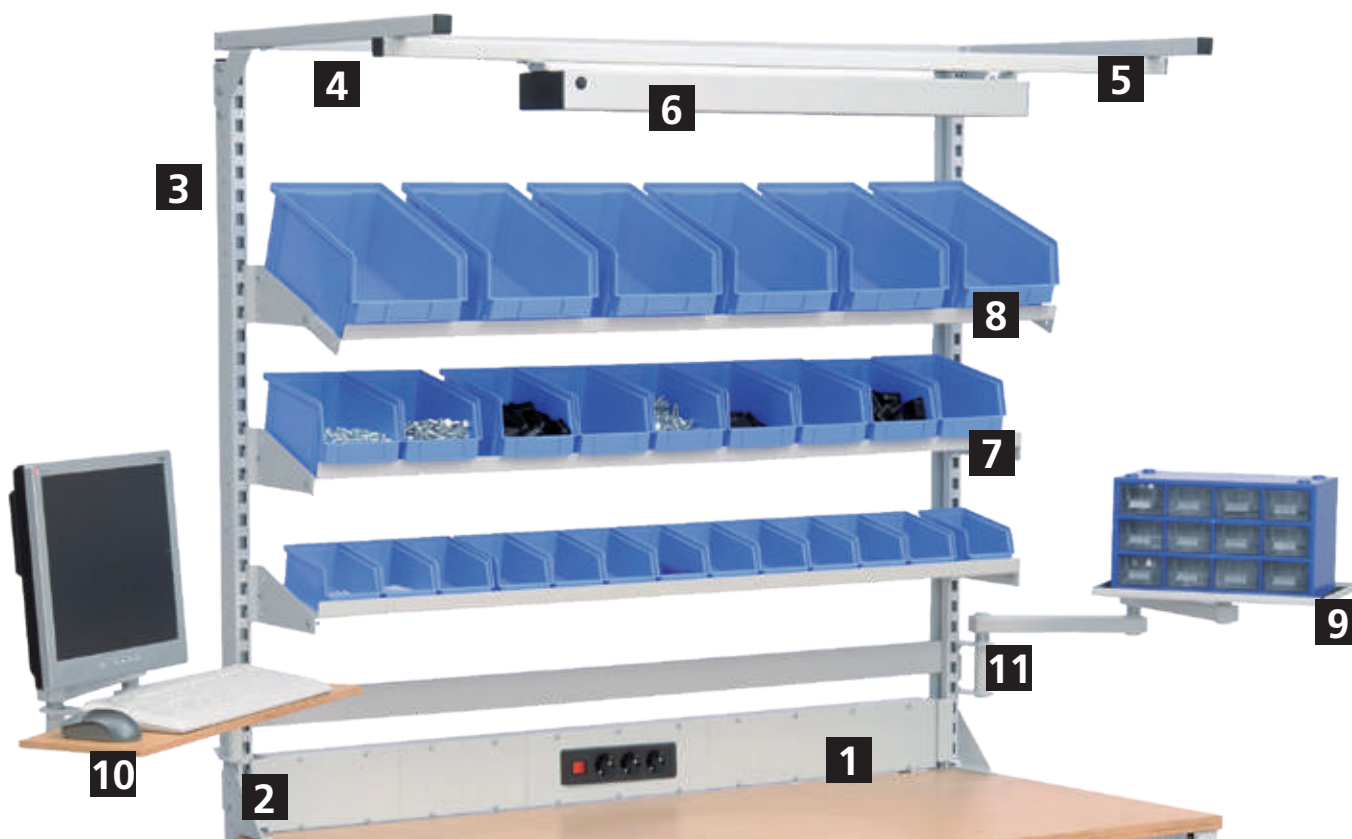

Setup example

- Setup 1500 mm
- Overhead frame with equipment rail and lighting
- 1x shelf, 220 mm
- 2x shelf, 320 mm
- 3x earthed sockets with 1x on/off switch
- 1x pivot arm with shelf
- 1x pivot arm with monitor bracket and keyboard platform

Pos.	Item no.	Dimensions in mm (W x D x H)	Description
1	07.861.15.10	1375 x 60 x 130	Energy duct , fully equipped and wired, 3x earthed socket with on/off switch
2	07.861.01-1	33 x 38 x 117	Energy duct mounting bracket for basic module. Bracket right and left for mounting between support columns
3	03.15.14.01	1500 x 1491	Support columns
4	07.8915.1	1500 x 750	Overhead frame with bolted reinforcement cross-members
5	03.915.03	1500 x 30 x 30	The equipment rail is mounted on the overhead frame and serves to accommodate the carriage, the lighting or a balancer.
6	03.960.20-1	898 x 135 x 60	Workplace lamp , light colour neutral white, energy efficiency class A, 230 V, 50 Hz, protection class IP 20, switch, incl. approx. 2.9 m mains cable and mains plug
7	03.915.220	1500 x 220 x 20	Shelf, 1500 mm , for hanging between the support columns, adjustable height and incline, inclination 0°, 10° and 20° incl. roll-off edge
8	03.915.320	1500 x 320 x 20	
9	07.98.11	420 x 300 x 20	Pivot arm with shelf and ribbed rubber mat , load capacity 25 kg, pivot arm bracket mandatory, not suitable for mounting on superstructure stand
10	07.98.08	700 x 355 x 322	Pivot arm with monitor bracket and keyboard platform , VESA 75/100 mm, beech multiplex shelf, 20 mm, pivot arm bracket mandatory, not suitable for mounting on superstructure stand
11	07.98.02		Pivot arm bracket

Supplied without hooks, boxes and decoration

Multi-board setup for C- and 4-foot base frames

workergo workplace systems

All variants: Overhead frame with equipment rail and lighting, **variant 1500 mm:** 2x support column

Variant 2000 mm: 3x support column, the number of perforated walls, magnetic boards and shelves doubles.



- 2x perforated wall
- 1x magnetic board
- 1x energy bar with 3x earthed sockets and on/off switch

Item no.	Dimensions in mm (W x D x H)
4C150-1	1500 x 750 x 1250
4C200-1	2000 x 750 x 1250

Item no.	Dimensions in mm (W x D x H)
4C150-2	1500 x 750 x 1250
4C200-2	2000 x 750 x 1250



- 2x perforated wall
- 1x shelf, 320 mm
- 1x shelf, 220 mm

- 2x perforated wall
- 1x shelf, 320 mm
- 1x energy bar with 3x earthed sockets and on/off switch
- 1x pivot arm with 20 mm beech multiplex platform
- 1x pivot arm with shelf and ribbed rubber mat

Item no.	Dimensions in mm (W x D x H)
4C150-3	1500 x 750 x 1250
4C200-3	2000 x 750 x 1250

Item no.	Dimensions in mm (W x D x H)
4C150-4	1500 x 750 x 1250
4C200-4	2000 x 750 x 1250



- 1x perforated wall
- 1x shelf, 320 mm
- 2x shelf, 220 mm
- 1x pivot arm with document holder
- 1x pivot arm with monitor bracket and keyboard platform

- 1x shelf, 320 mm
- 2x shelf, 220 mm
- 1x energy bar with 3x earthed sockets and on/off switch
- 1x pivot arm with monitor bracket and keyboard platform
- 1x pivot arm with shelf and ribbed rubber mat

Item no.	Dimensions in mm (W x D x H)
4C150-5	1500 x 750 x 1250
4C200-5	2000 x 750 x 1250

Item no.	Dimensions in mm (W x D x H)
4C150-6	1500 x 750 x 1250
4C200-6	2000 x 750 x 1250

Supplied without hooks, boxes and decoration





Supports for hanging cabinets

- Mandatory for installation of hanging cabinets
- Packing unit: 2 pieces

Item no.	Table depth in mm
4XXXXX75TR	750
4XXXXX90TR	900



Hanging base cabinet R 12-16/R 18-16

- Empty housing

Item no.	Dimensions in mm (W x D x H)	Usable height in mm
01.033	381 x 500 x 365	300
01.034	381 x 500 x 465	400
01.053	531 x 500 x 365	300
01.054	531 x 500 x 465	400

Hanging base cabinet R 18-24

- Empty housing

Item no.	Dimensions in mm (W x D x H)	Usable height in mm
01.0520	555 x 736 x 215	150
01.0530	555 x 736 x 365	300
01.0540	555 x 736 x 465	400



Drawer R 12-16/R18-16

- Full pull-out 100 %
- Load capacity 50 kg
- All specifications are usable dimensions

Item no.	Front height	Dimensions in mm (W x D x H)
60.038.100VA	100	300 x 400 x 90
60.038.150VA	150	300 x 400 x 140
60.046.075VA	75	450 x 400 x 65
60.046.100VA	100	450 x 400 x 90
60.046.150VA	150	450 x 400 x 140

Drawer R 18-24

- Full pull-out 100 %
- Load capacity 70 kg with 50 mm front height
- Load capacity 100 kg with 100 mm front height
- All specifications are usable dimensions

Item no.	Front height	Dimensions in mm (W x D x H)
60.50.050V07	50	450 x 600 x 30
60.50.100V10	100	450 x 600 x 83
60.50.150V10	150	450 x 600 x 133
60.50.200V10	200	450 x 600 x 183

■ Installation not possible ■ Installation possible



Base cabinets with 736 mm depth cannot be used with table depths of 750 mm. These can only be installed from a table depth of 900 mm. Base Cabinets are not possible with a table depth of 600 mm.

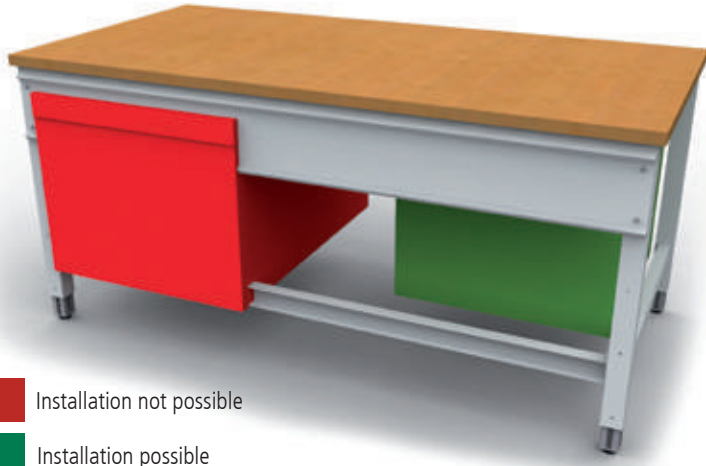

- Installation not possible
- Installation possible



PC support H

- For attachment under the worktop
- Width adjustable

Item no.	Dimensions in mm (WxDxH)
07.89.06	250 x 550 x 500



- 1x hinged door, 350 mm

Item no.	Dimensions in mm (W x D x H)
44.001	531 x 500 x 465



- 2x drawer, 200 mm

Item no.	Dimensions in mm (W x D x H)
38.011	381 x 500 x 465
44.011	531 x 500 x 465



- 1x drawer, 150 mm

Item no.	Dimensions in mm (W x D x H)
38.150	381 x 500 x 215
53.150	531 x 500 x 215
520/1VA-1	555 x 736 x 215



- 3x drawer, 100 mm

Item no.	Dimensions in mm (W x D x H)
38.300	381 x 500 x 365
53.300	531 x 500 x 365



- 3x drawer: 1x 50 mm, 1x 100 mm, 1x 150 mm

Item no.	Dimensions in mm (W x D x H)
530.111V	555 x 736 x 365



- 4x drawer, 100 mm

Item no.	Dimensions in mm (W x D x H)
38.020	381 x 500 x 465
53.020	531 x 500 x 465
535/020V	555 x 736 x 465



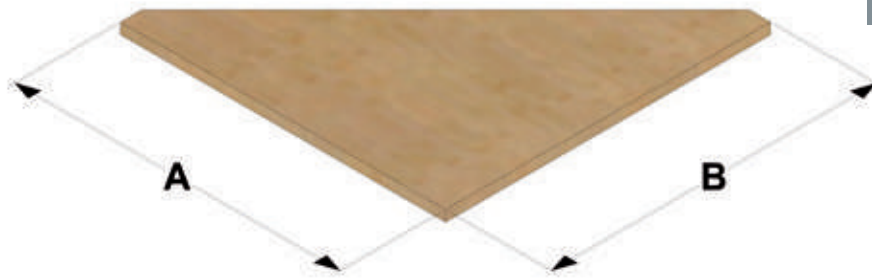

■ Corner panels for table-to-table connection



Beech multiplex 25 mm

- Glue laminated, oiled
- Waterproof
- Dampened according to DIN 68705

Clamp fixing and electric height adjustment	
A x B in mm	Item no.
600 x 600	BE1.6060K25
600 x 750	BE1.6075K25
600 x 900	BE1.6090K25
750 x 600	BE1.7560K25
750 x 750	BE1.7575K25
750 x 900	BE1.7590K25
900 x 600	BE1.9060K25
900 x 750	BE1.9075K25
900 x 900	BE1.9090K25



Chipboard panel, 28 mm, directly coated with melamine resin

- 4-sided, ABS edging
- Chipboard carrier plate with direct coating
- Abrasion-resistant and easy to care for surface

A x B in mm	Item no.
600 x 600	ME1.6060K28
600 x 750	ME1.6075K28
600 x 900	ME1.6090K28
750 x 600	ME1.7560K28
750 x 750	ME1.7575K28
750 x 900	ME1.7590K28
900 x 600	ME1.9060K28
900 x 750	ME1.9075K28
900 x 900	ME1.9090K28



MDF worktop, 30 mm, with 0.7 mm HPL coat

- 4-sided, ABS edging
- Heat and light resistant
- Stain-resistant, easy to clean and to disinfect

A x B in mm	Item no.
600 x 600	HE1.6060K30
600 x 750	HE1.6075K30
600 x 900	HE1.6090K30
750 x 600	HE1.7560K30
750 x 750	HE1.7575K30
750 x 900	HE1.7590K30
900 x 600	HE1.9060K30
900 x 750	HE1.9075K30
900 x 900	HE1.9090K30



ESD conductive workbench top, 30 mm

- Surface made from conductive HPL laminate
- Suitable for all electrostatically sensitive areas
- Surface RAL 7035



A x B in mm	Item no.
600 x 600	EE1.6060K30
600 x 750	EE1.6075K30
600 x 900	EE1.6090K30
750 x 600	EE1.7560K30
750 x 750	EE1.7575K30
750 x 900	EE1.7590K30
900 x 600	EE1.9060K30
900 x 750	EE1.9075K30
900 x 900	EE1.9090K30



■ Corner panels for table-to-table connection



Beech multiplex 25 mm

- Glue laminated, oiled
- Waterproof
- Dampened according to DIN 68705

Clamp fixing and electric height adjustment	
A x B in mm	Item no.
600 x 600	BE2.6060K25
600 x 750	BE2.6075K25
600 x 900	BE2.6090K25
750 x 600	BE2.7560K25
750 x 750	BE2.7575K25
750 x 900	BE2.7590K25
900 x 600	BE2.9060K25
900 x 750	BE2.9075K25
900 x 900	BE2.9090K25



Chipboard panel, 28 mm, directly coated with melamine resin

- 4-sided, ABS edging
- Chipboard carrier plate with direct coating
- Abrasion-resistant and easy to care for surface

A x B in mm	Item no.
600 x 600	ME2.6060K28
600 x 750	ME2.6075K28
600 x 900	ME2.6090K28
750 x 600	ME2.7560K28
750 x 750	ME2.7575K28
750 x 900	ME2.7590K28
900 x 600	ME2.9060K28
900 x 750	ME2.9075K28
900 x 900	ME2.9090K28



MDF worktop, 30 mm, with 0.7 mm HPL coat

- 4-sided, ABS edging
- Heat and light resistant
- Stain-resistant, easy to clean and to disinfect

A x B in mm	Item no.
600 x 600	HE2.6060K30
600 x 750	HE2.6075K30
600 x 900	HE2.6090K30
750 x 600	HE2.7560K30
750 x 750	HE2.7575K30
750 x 900	HE2.7590K30
900 x 600	HE2.9060K30
900 x 750	HE2.9075K30
900 x 900	HE2.9090K30



ESD conductive workbench top, 30 mm

- Surface made from conductive HPL laminate
- Suitable for all electrostatically sensitive areas
- Surface RAL 7035



A x B in mm	Item no.
600 x 600	EE2.6060K30
600 x 750	EE2.6075K30
600 x 900	EE2.6090K30
750 x 600	EE2.7560K30
750 x 750	EE2.7575K30
750 x 900	EE2.7590K30
900 x 600	EE2.9060K30
900 x 750	EE2.9075K30
900 x 900	EE2.9090K30





workline - the highest one



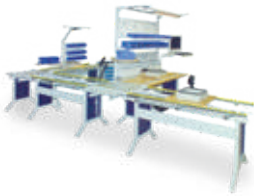

workline and linkage

Page 358



workline Linkage accessories

Page 360



workline Combinations from practice with multi-board setup

Page 365



workline Multi-board setup

Page 366



workline Combinations from practice with superstructure stand

Page 368



workline Basic tables and add-on tables

Page 370



workline corner panels and base cabinets

Page 372



workline Superstructure stand | Accessories

Page 373





Grid subdivision



Series
workline



Housing W x D
365 x 400

Height	Usable heights
500	400



Drawer W x D
300 x 350

Height	Load capacity
100	20 kg
200	20 kg
400	20 kg



Series
workline
T370 12-14

Grid:	R 12-14
-------	----------------

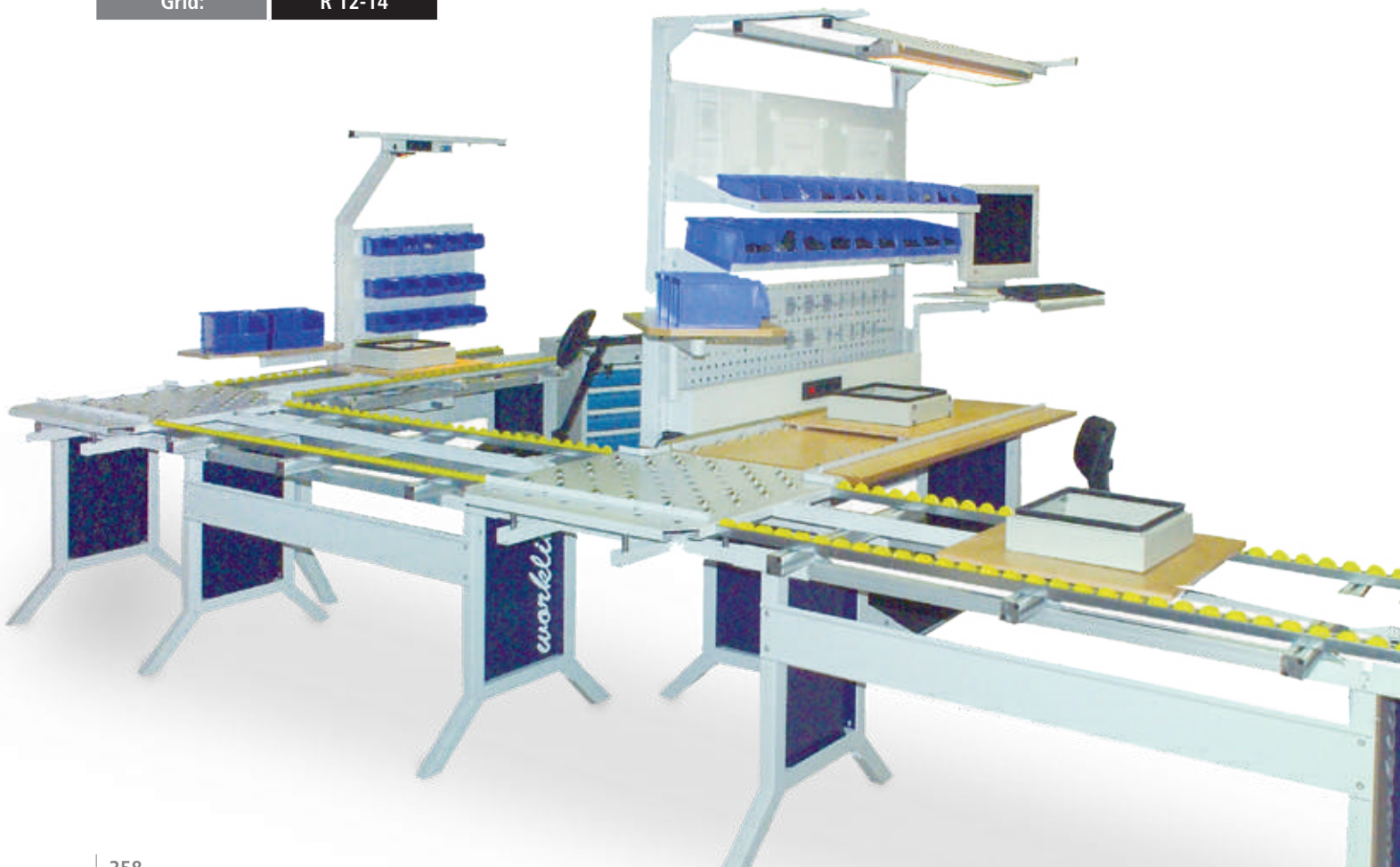

workline - the highest one

The **workline** worktable achieves a working height of 1100 mm thanks to its continuous height adjustment and is therefore also an optimal standing workplace. At the same time, its simple and functional design ensures an ergonomic seated workplace.

- Standard colours: RAL 7035 Light grey / RAL 5013 Cobalt blue
- Base frame made of 45 x 45 mm steel tube Cross-members made of 40 x 40 mm aluminium sections



i Please note that workline tables are delivered unassembled. Easy self-assembly!

Our features at a glance	
Modular system	Individual workstations can be quickly expanded to group workstations
Retrofittable	Wide range of accessories: Flexible design and conversion of the workplace
Energy	Direct supply of lighting, power, compressed air
Frame widths	1000, 1500 mm
Frame depth	750 mm
Travel speed	6.25 mm/s
Work height without worktop	735 – 1100 mm Vertical travel: 365 mm
Height adjustment	Three different types: Clamp fixing, crank adjustment, electric height adjustment
Frame design	A-foot
Load capacity	180-200 kg with uniform load depending on height adjustment

FRAME DESIGN:

WL
1



Basic table



Add-on table

HEIGHT ADJUSTMENT:

WL
1



Clamp fixing

WL
2



Crank adjustment

WL
3



Electric height adjustment, 1 motor





Basic table with worktop



workline basic table with clamp fixing

- Beech multiplex worktop 25 mm



Item no.	Dimensions in mm (WxDxH)
07.75.10	1000 x 750 x 735 – 1100
07.75.15	1500 x 750 x 735 – 1100

workline basic table with crank adjustment

- Beech multiplex worktop 25 mm



Item no.	Dimensions in mm (WxDxH)
07.75.10KHV	1000 x 750 x 735 – 1100
07.75.15KHV	1500 x 750 x 735 – 1100

workline basic table with electric height adjustment

- Beech multiplex worktop 25 mm



Item no.	Dimensions in mm (WxDxH)
07.75.10EHV	1000 x 750 x 735 – 1100
07.75.15EHV	1500 x 750 x 735 – 1100

**workline add-on table with clamp fixing**

- Beech multiplex worktop 25 mm
- Can be used left or right



Item no.	Dimensions in mm (WxDxH)
07.10.15	1000 x 750 x 735 – 1100
07.15.15	1500 x 750 x 735 – 1100

workline add-on table gear drive for crank adjustment and electric height adjustment

- Beech multiplex worktop 25 mm
- Can be used left or right - Please state the side when ordering



Item no.	Dimensions in mm (WxDxH)
07.10.15KHV	1000 x 750 x 735 – 1100
07.15.15KHV	1500 x 750 x 735 – 1100





Basic frame

You can find multi-board accessories on/from page 422



WL	kg
1	200

workline basic table with clamp fixing

Item no.	Dimensions in mm (WxDxH)
07/10/1970	1000 x 750 x 735 – 1100
07/10/1975	1500 x 750 x 735 – 1100



WL	kg
2	200

workline basic frame with crank adjustment

Item no.	Dimensions in mm (WxDxH)
07.10.70KHV	1000 x 750 x 735 – 1100
07.10.75KHV	1500 x 750 x 735 – 1100



WL	kg
3	180

workline basic frame with electric height adjustment

Item no.	Dimensions in mm (WxDxH)
07.10.70EHV	1000 x 750 x 735 – 1100
07.10.75EHV	1500 x 750 x 735 – 1100

The add-on table only requires crank adjustment if the basic table is electrically adjustable. 1x motor for 1x basic table and 1x add-on table



Crank adjustment retrofit kit

- For one base or add-on table maximum

Item no.	Designation
07.00.42	Crank adjustment basic table 1000
07.00.43	Crank adjustment add-on table 1000
07.00.40	Crank adjustment basic table 1500
07.00.41	Crank adjustment add-on table 1500

Electric height adjustment retrofit kit

- The crank height adjustment is a prerequisite for the electrical height adjustment
- For one base and add-on table maximum

Item no.	Designation
07.00.45	Electrical height adjustment



workline add-on frame with clamp fixing

- Can be used left or right



WL
1 kg 200

Item no.	Dimensions in mm (WxDxH)
07/10/1972	1000 x 750 x 735 – 1100
07.15.72	1500 x 750 x 735 – 1100



WL
2 kg 200

workline add-on frame with gear drive for crank adjustment and electric height adjustment

- Can be used left or right - Please state the side when ordering



WL
3 kg 180

Item no.	Dimensions in mm (WxDxH)
07.10.72KHV	1000 x 750 x 735 – 1100
07.15.72KHV	1500 x 750 x 735 – 1100

Basic and add-on table connection



workline basic table and add-on table

- incl. 2x beech multiplex worktop 25 mm

Item no.	Dimensions in mm (WxDxH)	Design
07.30.15	3000 x 750 x 735 – 1100	Clamp adjustment
07.30.15KHV	3000 x 750 x 735 – 1100	Crank adjustment
07.30.15EHV	3000 x 750 x 735 – 1100	Electric height adjustment





workline basic table

- Beech multiplex worktop 25 mm
- 1x drawer, 100 mm
- 1x footrest

Item no.	Load capacity in kg	Dimensions in mm (WxDxH)
07.25.25	200	1000 x 750 x 735 – 1100 with clamp fixing
07.75.25KHV	200	1000 x 750 x 735 – 1100 with crank adjustment
07.75.25EHV	180	1000 x 750 x 735 – 1100 with electric height adjustment



workline basic table

- Beech multiplex worktop 25 mm
- 1x shelf, 3rd level

Item no.	Load capacity in kg	Dimensions in mm (WxDxH)
07.75.41	200	1500 x 750 x 735 – 1100 with clamp fixing
07.75.41KHV	200	1500 x 750 x 735 – 1100 with crank adjustment
07.75.41EHV	180	1500 x 750 x 735 – 1100 with electric height adjustment



Footrest

- Only for workline tables
- Inclined, coated with anti-slip mat
- W x D x H: 400 x 350 x 20 mm

Item no.	Design
07.00.20	Basic table 1000
07.00.21	Add-on table 1000
07.00.25	Basic table 1500
07.00.26	Add-on table 1500



Shelf, 3rd level

- Beech multiplex 25 mm

Item no.	Dimensions in mm (WxDxH)
07.25.33	1000 x 260 x 300
07.25.35	1500 x 260 x 300

Corner connection for two basic tables

- 1x corner worktop or
- 1x triangular worktop



Corner worktop without corner connector

- Beech multiplex

Item no.	Dimensions in mm (WxDxH)
07.25.90	750 x 750 x 25

- Chipboard panel melamine resin

Item no.	Dimensions in mm (WxDxH)
07.26.91	750 x 750 x 28

- ESD conductive

Item no.	Dimensions in mm (WxDxH)
07.24.91	750 x 750 x 30

Table-to-table connector see page 430

Triangular worktop without corner connector

- Beech multiplex

Item no.	Dimensions in mm (WxDxH)
07.27.90	750 x 750 x 25

- Chipboard panel melamine resin

Item no.	Dimensions in mm (WxDxH)
07.28.91	750 x 750 x 28

- ESD conductive

Item no.	Dimensions in mm (WxDxH)
07.29.91	750 x 750 x 30

Base cabinets, load capacity of drawers 20 kg

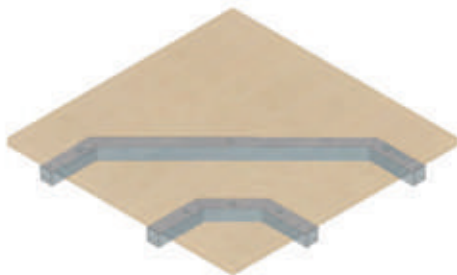

Corner connector

- Steel tube

Item no.	Description
07.30.90	90° connection

Hanging drawer blocks

- 1 x drawer, 400 mm
- 1x bottle holder and intermediate support
- 2x shelf and frame for suspension files

Item no.	Dimensions in mm (WxDxH)
07.18.00	365 x 400 x 500

Hanging drawer blocks

- 1x drawer, 100 mm

Item no.	Dimensions in mm (WxDxH)
07.18.01	365 x 400 x 140



Hanging drawer blocks

- 2x drawer, 100 mm
- 1x drawer, 200 mm

Item no.	Dimensions in mm (WxDxH)
07.18.03	365 x 400 x 500

Hanging drawer blocks

- 4x drawer, 100 mm

Item no.	Dimensions in mm (WxDxH)
07.18.04	365 x 400 x 500

Hanging drawer blocks

- 2x drawer, 200 mm

Item no.	Dimensions in mm (WxDxH)
07.18.02	365 x 400 x 500





You can find multi-board accessories on/from page 284



workline basic table with clamp fixing

Multi-board setup

- 2x support column
- 1x overhead frame
- 1x equipment rail
- 1x LED illumination 28.9 W, 1290 lx
- 1x magnetic board and 1x perforated wall, 302 mm
- 2x inclinable shelf, 320 mm

Item no.	Dimensions in mm (WxDxH)	Design
07.75.15	1500 x 750 x 735 – 1100	workline basic table
03.900.15.13	1500 x 750 x 1250	Multi-board setup



100
100
200

workline basic table with crank adjustment

- 1x footrest
- 1x drawer block with 3x drawer, load capacity 20 kg

Multi-board setup

- 2x support column
- 1x energy bar with 3x earthed sockets and on/off switch
- 1x perforated wall, 1 magnetic board, 2x shelf, 320 mm
- 2x pivot arm support
- 1x pivot arm with platform
- 1x pivot arm with monitor bracket and keyboard platform
- 1x overhead frame, 1x equipment rail
- 1x LED illumination 28.9 W, 1290 lx

Item no.	Dimensions in mm (WxDxH)	Design
07.75.17	1500 x 750 x 735 – 1100	workline basic table
03.900.75.18	1500 x 750 x 1250	Multi-board setup

Supplied without hooks, boxes and decoration



workline basic and add-on table combination with clamp fixing

- Beech multiplex worktop 25 mm

Multi-board setup

- 3x support column
- 1x energy bar with 3x earthed sockets and on/off switch
- 1x perforated wall
- 1x shelf, 220 mm
- 1x shelf, 320 mm
- 1x multi roller shutter cabinet
- 1x overhead frame, 1x equipment rail
- 1 pair of joists
- 1x LED illumination 28.9 W, 1290 lx

Item no.	Dimensions in mm (WxDxH)	Design
07.20.15/40	2000 x 750 x 735 – 1100	workline basic table and add-on table
03.900.21	2000 x 750 x 1250	Multi-board setup



workline basic and add-on table combination with crank adjustment

- 2x beech multiplex worktop 25 mm
- 1x drawer block with 3x drawer, load capacity 20 kg
- 1x superstructure frame
- 1x pivot arm with monitor bracket and keyboard platform

Multi-board setup 1500 mm

- 2x support column, 1x overhead frame
- 1x equipment rail
- 1x LED illumination 28.9 W, 1290 lx
- 1x energy bar with 3x earthed sockets and on/off switch
- 1x magnetic board and 1x perforated wall, 302 mm
- 1x shelf, 320 mm

Item no.	Dimensions in mm (WxDxH)	Design
07.10.15.10.96	3000 x 750 x 735 – 1100	workline basic and add-on table with multi-board setup

Supplied without hooks, boxes and decoration





Multi-board setup



Suitable for mounting on workline worktables

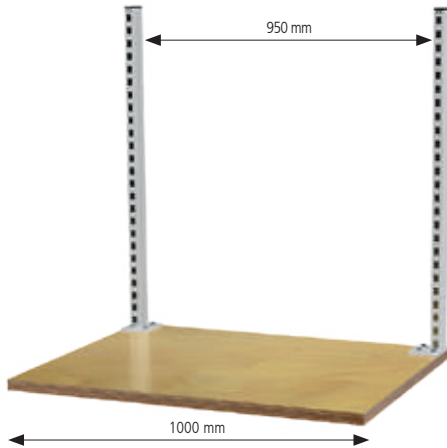

- Table width 1000 mm
- Superstructure width centre-centre 950 mm
- 1x support column left
- 1x support column right

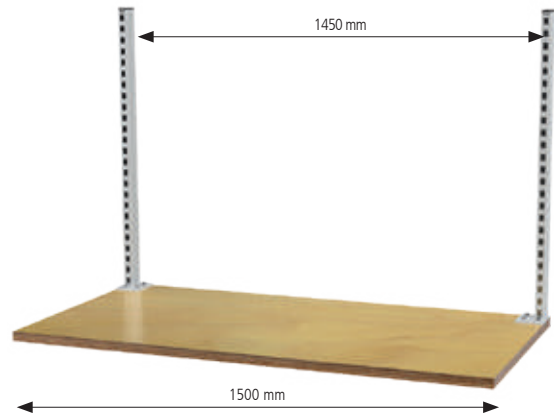

- Table width 1500 mm
- Superstructure width centre-centre 1450 mm
- 1x support column left
- 1x support column right

Support column profile 30 x 60 mm

- Reinforced by U-profile tube
- Lower panel thicknesses on request
- 3 support columns are required for assembly on 2 m work surfaces



Item no.	Dimensions in mm
03.935.650.225	650 left
03.935.650.125	650 right
03.935.950.225	950 left
03.935.950.125	950 right
03.935.125.225	1250 left
03.935.125.125	1250 right

Multi-board setup

workline workplace systems



- 2x support column, 1x overhead frame, 1x equipment rail
- 1x LED illumination 28.9 W, 1290 lx
- 1x energy bar with 3x earthed sockets and on/off switch
- 2x 1/4" compressed air connection, 2x shelf, 320 mm
- 1x perforated wall
- 1x pivot arm with platform, 1 x Swivel arm holder

Item no.	Dimensions in mm (WxDxH)
03.9001524WL	1500 x 750 x 1250



- 2x support column, 1x overhead frame, 1x equipment rail
- 1x LED illumination 28.9 W, 1290 lx
- 1x energy bar with 3x earthed sockets and on/off switch
- 3x shelf, 320 mm, 1x perforated wall

Item no.	Dimensions in mm (WxDxH)
03.9001525WL	1500 x 750 x 1250

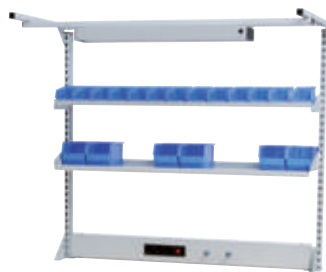

- 2x support column, 1x overhead frame, 1x equipment rail
- 1x LED illumination 28.9 W, 1290 lx
- 1x energy bar with 3x earthed sockets and on/off switch
- 2x 1/4" compressed air connection, 2x shelf, 320 mm

Item no.	Dimensions in mm (WxDxH)
03.9001523WL	1500 x 750 x 1250

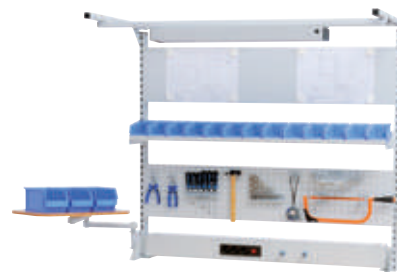

- 2x support column, 1x overhead frame, 1x equipment rail
- 1x LED illumination 28.9 W, 1290 lx
- 1x energy bar with 3x earthed sockets and on/off switch
- 2x 1/4" compressed air connection, 1x shelf, 320 mm, 1x perforated wall, 1x magnetic board
- 1x pivot arm with platform, 1 x Swivel arm holder

Item no.	Dimensions in mm (WxDxH)
03.9001521WL	1500 x 750 x 1250



- 2x support column, 1x overhead frame, 1x equipment rail
- 1x LED illumination 28.9 W, 1290 lx
- 1x energy bar with 3x earthed sockets and on/off switch
- 4x shelf, 320 mm

Item no.	Dimensions in mm (WxDxH)
03.9001522WL	1500 x 750 x 1250



- 2x support column, 1x overhead frame, 1x equipment rail
- 1x LED illumination 28.9 W, 1290 lx
- 1x energy bar with 3x earthed sockets and on/off switch
- 2x 1/4" compressed air connection, 1x shelf, 320 mm
- 1x perforated wall, 1x magnetic board

Item no.	Dimensions in mm (WxDxH)
03.9001520WL	1500 x 750 x 1250





You can find superstructure stand accessories on/from page 372



workline basic table

- Beech multiplex worktop 25 mm
- 1x drawer block with 3x drawer: 2x 100 mm, 1x 200 mm, load capacity 20 kg

Superstructure frame

- 1x superstructure frame for stand
- 1x stand with 2x earthed sockets and 1x halogen lamp
- 1x pivot arm with shelf
- 1x pivot arm with perforated/slotted wall
- Without spring balancer and open front storage bins

Item no.	Dimensions in mm (WxDxH)	Design
07.75.96	1500 x 750 x 735 – 1100	Clamp fixing
07.75.96KHV	1500 x 750 x 735 – 1100	Crank fixing

workline basic table

- Beech multiplex worktop 25 mm
- 1x footrest, 1x PC support
- 1x drawer block with 1x drawer: 100 mm, load capacity 20 kg

Superstructure frame

- 1x superstructure frame for stand
- 1x stand with 2x earthed sockets and 1x halogen lamp
- 1x pivot arm with monitor and keyboard platform

Item no.	Dimensions in mm (WxDxH)	Design
07.75.55	1500 x 750 x 735 – 1100	Clamp fixing
07.75.55KHV	1500 x 750 x 735 – 1100	Crank fixing



PC support H

- For attachment under the worktop
- Width adjustable

Item no.	Dimensions in mm (WxDxH)
07.89.06	250 x 550 x 500



Foot shelf

- Only for workline tables
- Beech multiplex top 25 mm

Item no.	Dimensions in mm (WxD)	Design
07.30.20	1000 x 350	Basic table
07.30.21	1000 x 350	Add-on table
07.30.25	1500 x 350	Basic table
07.30.26	1500 x 350	Add-on table



workline basic table

- Beech multiplex worktop 25 mm
- 1x drawer block with 1x drawer, 100 mm, load capacity 20 kg
- 1x shelf, 3rd level beech multiplex (top)

Superstructure frame

- 1x superstructure frame for stand
- 1x stand with 2x earthed sockets and 1x halogen lamp

Item no.	Dimensions in mm (WxDxH)	Design
07.75.46	1500 x 750 x 735 – 1100	Clamp fixing
07.75.46KHV	1500 x 750 x 735 – 1100	Crank fixing

workline basic table

- Beech multiplex worktop 25 mm

Superstructure frame

- 1x superstructure frame for stand
- 1x stand with 2x earthed sockets and 1x halogen lamp

Item no.	Dimensions in mm (WxDxH)	Design
07.75.35	1500 x 750 x 735 – 1100	Clamp fixing
07.75.35KHV	1500 x 750 x 735 – 1100	Crank fixing



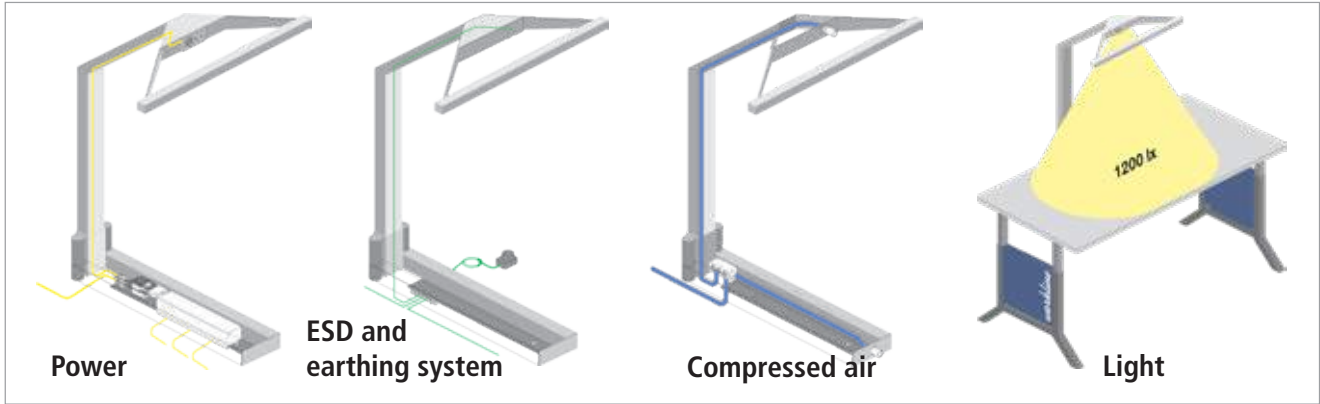

Superstructure frame below the worktop



Please note:

Mandatory for stand and pivot arms

Item no.	Dimensions in mm (WxDxH)
07.40.00	610 x 170 x 130
07.40.01	Surcharge power supply
07.40.02	Surcharge compressed air distributor

Stand

- For structures with 2x earthed sockets and 1x halogen lightning 35 W
- Total height 1130 mm

Item no.	Design
07.40.06	Standard
07.40.07	Surcharge for compressed air distributor

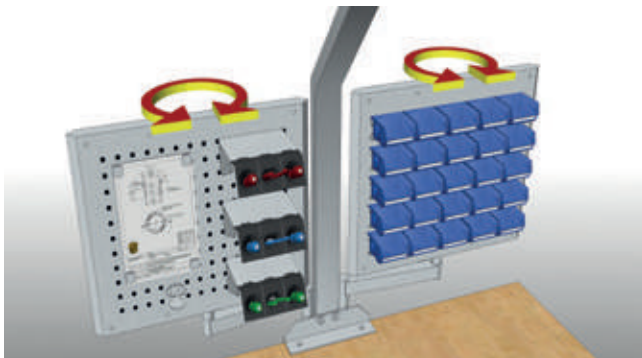

360° pivot arm inserts offer maximum flexibility for the work to be carried out.



Sockets, compressed air connections and a halogen lamp are integrated into the stand. This saves the space an additional energy bar would require.



Please note:

- The superstructure frame below the worktop is mandatory for pivot arms
- Load capacity 25 kg



Pivot arm with pivot frame and shelves

- 2x inclinable shelf

Item no.	Dimensions in mm (WxDxH)
07.98.03	680 x 287 x 400



Pivot arm with depositing tray

Item no.	Dimensions in mm (WxDxH)
07.98.04	400 x 300 x 48



Pivot arm with document holder A4 Portrait format

- With raised lateral and bottom edge

Item no.	Dimensions in mm (WxDxH)
07.98.05	215 x 370 x 330



Pivot arm with document holder A4 Landscape format

- With raised bottom edge

Item no.	Dimensions in mm (WxDxH)
07.98.06	310 x 156 x 310



Pivot arm with monitor bracket

- VESA 75 / 100 mm

Item no.	Dimensions in mm (WxDxH)
07.98.07	130 x 370 x 320



Pivot arm with monitor bracket and keyboard platform

- VESA 75 / 100 mm
- Beech multiplex shelf, 15 mm

Item no.	Dimensions in mm (WxDxH)
07.98.08	700 x 355 x 322





Linkage accessories



workline roller ball table

- Beech multiplex worktop 25 mm
- 2x workpiece carrier stop
- Integrated roller ball rail
- Height-adjustable with clamp fixing
- incl. guide rails

Item no.	Depth of workpiece carrier in mm	Dimensions in mm (WxDxH)
07.60.10.40	384	1000 x 750 x 735 – 1100
07.60.15.40	384	1500 x 750 x 735 – 1100
07.60.10.50	500	1000 x 750 x 735 – 1100
07.60.15.50	500	1500 x 750 x 735 – 1100
07.60.10.60	616	1000 x 750 x 735 – 1100
07.60.15.60	616	1500 x 750 x 735 – 1100

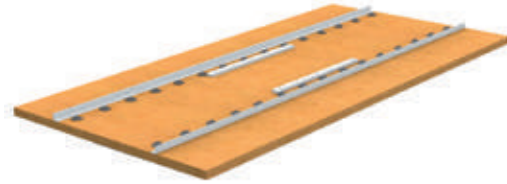

Beech multiplex worktop incl. roller ball rail

- Beech multiplex worktop 25 mm
- Integrated roller ball rail
- Incl. guide rails and 2 x workpiece carrier stop

Item no.	Depth of workpiece carrier in mm	Dimensions in mm (WxDxH)
07.60.90	384	1000 x 750 x 25
07.60.91	384	1500 x 750 x 25
07.60.92	500	1000 x 750 x 25
07.60.93	500	1500 x 750 x 25
07.60.94	616	1000 x 750 x 25
07.60.95	616	1500 x 750 x 25



workline basic table with small roller conveyor

- 1x small roller conveyor up to 600 mm depth
- Continuously height-adjustable with clamp fixing

Item no.	Dimensions in mm (WxDxH)
07.60.100	1000 x 600 x 790 – 1100
07.60.150	1500 x 600 x 790 – 1100



workline add-on table with small roller conveyor

- 1x small roller conveyor up to 600 mm depth
- Continuously height-adjustable with clamp fixing

Item no.	Dimensions in mm (WxDxH)
07.61.100	1000 x 600 x 790 – 1100
07.61.150	1500 x 600 x 790 – 1100

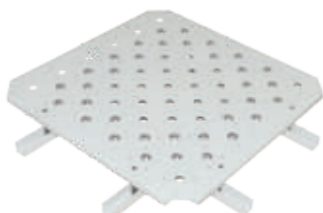

Roller ball table - bridge

- Without guide rails
- For an intersection with 3 or 4 junctions

Item no.	Dimensions in mm (WxD)
07.60.70	3 junctions - 750 x 750
07.60.71	4 junctions - 750 x 750



Roller ball table - end module

- Without guide rails, with one intersection and two junctions

Item no.	Dimensions in mm (WxD)
07.61.70	750 x 750



Workpiece carrier rail with 1x stopper

Item no.	Width in mm
07.60.03	1000
07.60.01	1500



Stopper for workpiece carrier rail

Item no.
07.60.02

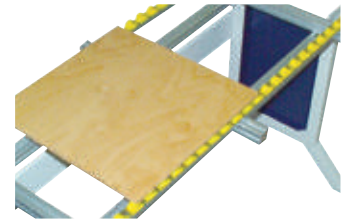

Beech multiplex workpiece carrier

Item no.	Dimensions in mm (WxDxH)
07.60.10	384 x 384 x 12
07.60.11	500 x 500 x 12
07.60.12	616 x 616 x 12

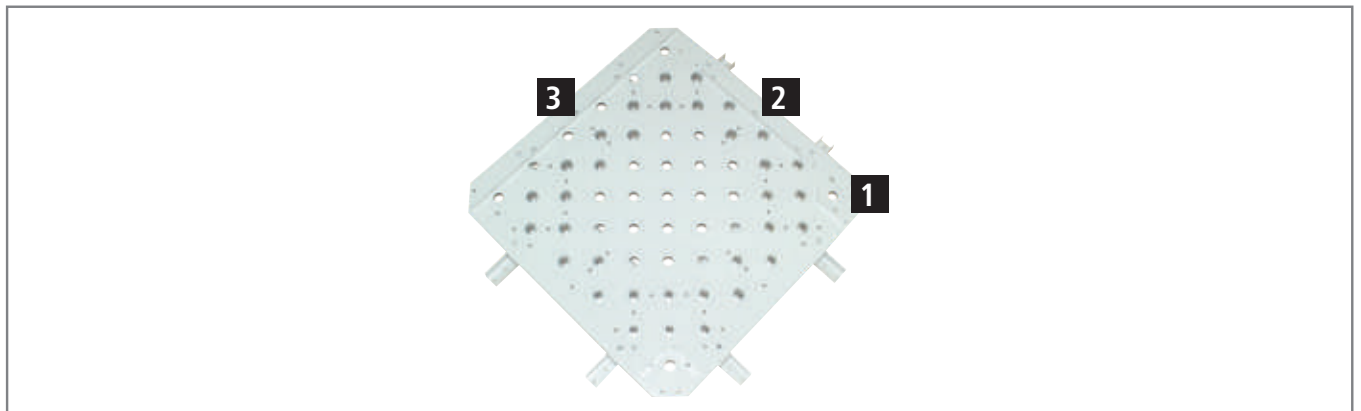

Guide bracket, pair

Item no.	Dimensions in mm
07.60.40	For workpiece carrier 384
07.60.42	For workpiece carrier 500
07.60.44	For workpiece carrier 616



End stop

Item no.	Dimensions in mm (WxDxH)
07.60.46	373 x 20 x 20



Guide rail

Item no.	Dimensions in mm
07.60.48	700

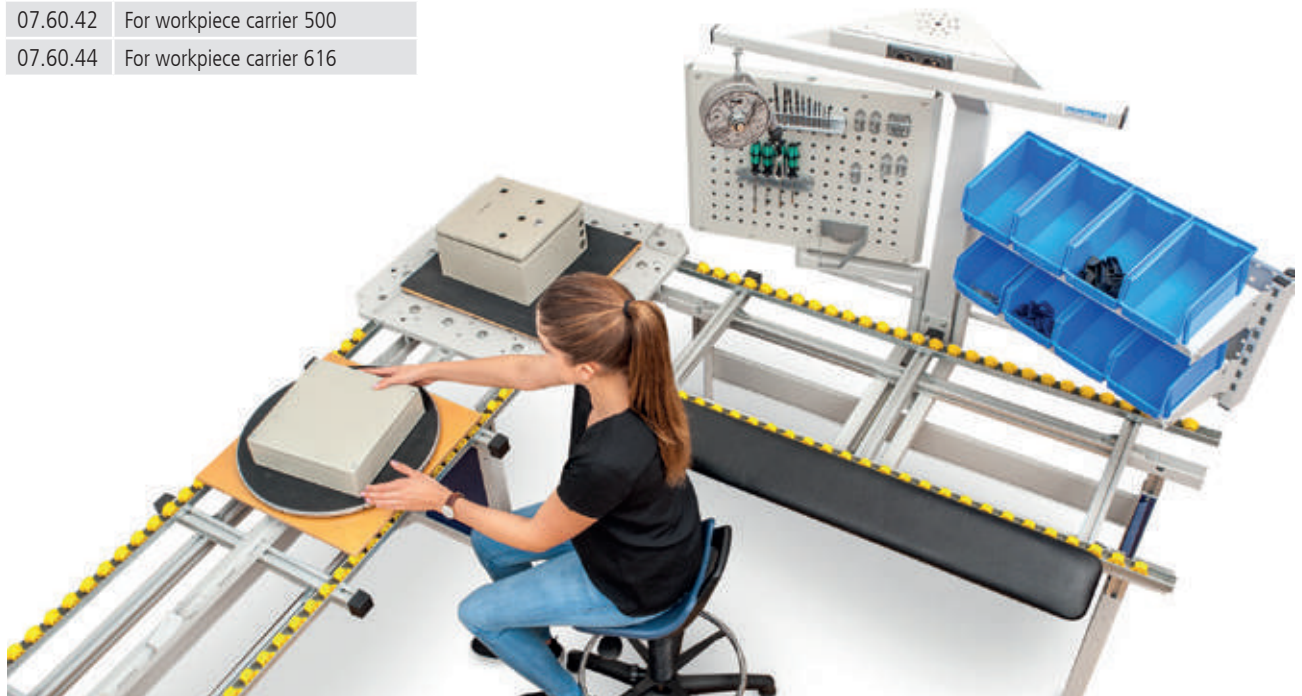



ROLLER CONVEYOR SYSTEMS

The conveying elements are standardised to optimise the internal material flow. With the tried-and-tested roller and wheel conveyor programme, we develop optimal concepts in unit load conveyor technology and realise projects in the areas of: Production, incoming goods, warehouse with picking zones, dispatch, the transport of light products, such as cardboard boxes, is mastered by the conveyor system as well as the handling of heavier goods, which can be moved gently on medium-heavy roller conveyors.

ACCORDION ROLLER CONVEYORS

Flared conveyors are independent, flexible conveyor sections. They are used where stationary conveyor sections cannot be installed and packages are handled manually. Thanks to their high degree of flexibility, they can be used as curves or even S-curves. Furthermore, their conveying length is variable (extendable), and they can be moved using steering casters.

- Also galvanised steel tube, Ø 50 x 1.5 mm, on request
- The centre distance is 55 - 130 mm, depending on the extended length
- Height-adjustable, 700 - 1100 mm
- Also ball bearing-mounted plastic rollers, Ø 48 mm, on request (without surcharge)
- The centre distance is 32 - 130 mm, depending on the extended length
- Height-adjustable, 700 - 1100 mm



Accordion roller conveyors with conveyor rollers made of blue plastic tube



Accordion small roller conveyors with ball bearing-mounted and galvanised steel rollerverzinkten Stahlröllchen

SMALL ROLLER CONVEYORS

For transporting small, light-weight conveyed goods. The conveyed goods should always lie over at least 3 conveyor rollers. Consequently, length and diameter of the smallest conveyed good:

min. 75 mm with a centre distance of 25 mm,

min. 115 mm with a centre distance of 37.5 mm.

The roller conveyor width determines the inner clearance between the roller conveyor frames. The conveyor rollers protrude over the upper edge of the frame.

The roller conveyor width determines the inner clearance between the roller conveyor frames. The conveyor rollers protrude over the upper edge of the frame.

Conveyor rollers \varnothing 20 mm or \varnothing 30 mm

Conveyor rollers made of blue plastic tube

Conveyor rollers made of galvanised steel tube

LIGHT ROLLER CONVEYORS

Light roller conveyors are used for transporting piece goods of a weight that can still be handled manually. The conveyed goods should always lie over at least 3 conveyor rollers (check centre distance). The roller conveyor width determines the inner clearance between the roller conveyor frames. The load capacity of the conveyors depends on, among other things, the roller conveyor width, and the roller and support spacing. With plastic rollers, the weight of the conveyed good should be no more than 20-25 kg. Supports are placed with a spacing of up to 2 m.

Conveyor rollers made of blue plastic tube

Conveyor rollers made of galvanised steel tube

MEDIUM-WEIGHT ROLLER CONVEYORS

For applications where light roller conveyors reach their load limits and heavy-duty roller conveyors would be oversized.

They are used for loads of up to approx. 150 - 200 kg/m, irrespective of the roller conveyor width, and the roller and support spacing. For multi-segment sections, the individual conveyors are connected via the supports (no track connectors).

Conveyor rollers made of galvanised steel tube





Heavy duty tables - The strongest



Page 380

Other workstation systems



Page 402

Worktops



Page 422

ESD



Page 432

Mobile logistics systems



Page 456

Wing and sliding door wardrobes



Page 530

Chairs and shelves



Page 552

Wardrobes



Page 578



Heavy load tables - the strongest ones





powerline C - height-adjustable heavy load tables with C-foot

Page 382



powerline C - basic frame and basic table with C-foot

Page 384



powerline C - combinations from practice with C-foot

Page 386



powerline C - height-adjustable heavy load tables with 4-foot

Page 388



powerline C - basic frame and basic table with 4-foot

Page 390



powerline C - combinations from practice with 4-foot

Page 392



hydline combinations from practice

Page 396



hydline

Page 394



Other heavy load tables

Page 400

powerline C



powerline C - the strong one

Thanks to its electric height adjustment, the **powerline** quietly moves to the required working height in a range of 705-1155 mm with a vertical travel speed of 9mm/s without load. Thus, the powerline creates a flexible seated/standing workplace without long waiting times. At the same time, the quiet worktable has an extremely high load capacity. The C-foot variant bears up to 600 kg.

- Feet with levelling
- **Drive:** Internal DC drive with built-in end switches and two synchronous Hall effect sensors
- **Connection:** 230 V | **Drive motor:** 24 V

**Features at a glance**

Retrofittable	Multi-board setup or stand and optional accessories such as foot switch
Energy	Direct supply of lighting, energy, compressed air
Frame widths	1250, 1500, 2000 mm
Frame depth	750 mm
Travel speed	9 mm/s without load
Work height without worktop	705 – 1155 mm Vertical travel: 450 mm
Height adjustment	Electric height adjustment
Frame design	C-foot
Load capacity	600 kg with even load

FRAME DESIGN:**HEIGHT ADJUSTMENT:**

Electric height adjustment



powerline C basic frame

- Equipped with up/down manual switch for height adjustment as standard
- Lifting columns made of aluminium
- Frame and feet made of rectangular tube and 5 mm thick sheet steel

Item no.	Dimensions in mm (WxDxH)
CF.125.75	1250 x 750 x 705 – 1155
CF.150.75	1500 x 750 x 705 – 1155
CF.200.75	2000 x 750 x 705 – 1155



powerline C basic table

- Beech multiplex top 40 mm
- Equipped with manual switch for height adjustment as standard
- Lifting columns made of aluminium
- Frame and feet made of rectangular tube and 5 mm thick sheet steel

Item no.	Dimensions in mm (WxDxH)
CF.125.75BM	1250 x 750 x 745 – 1195
CF.150.75BM	1500 x 750 x 745 – 1195
CF.200.75BM	2000 x 750 x 745 – 1195

You can find further worktops on/from page 422



Beech multiplex workbench top

- Glue laminated, oiled
- Waterproof
- Dampened according to DIN 68705

Panel thickness (mm)	40	50
Dimensions in mm (WxD)	Item no.	Item no.
1250 x 750	03.125.40	03.125.50
1500 x 750	03.15.40	03.15.50
2000 x 750	03.20.40	03.20.50



Chipboard panel directly coated with melamine resin

- 4-sided, ABS edging
- Chipboard carrier plate with direct coating
- Abrasion-resistant and easy to care for surface

Panel thickness (mm)	40	50
Dimensions in mm (WxD)	Item no.	Item no.
1250 x 750	07.M12575.40	07.M12575.50
1500 x 750	07.M1575.40	07.M1575.50
2000 x 750	07.M2075.40	07.M2075.50



Red beech workbench top

- Strip laminated
- Finger jointed
- Glued wood panel with distinctive grain

Panel thickness (mm)	40	50
Dimensions in mm (WxD)	Item no.	Item no.
1250 x 750	03.125.40RB	03.125.50RB
1500 x 750	03.15.40RB	03.15.50RB
2000 x 750	03.20.40RB	03.20.50RB

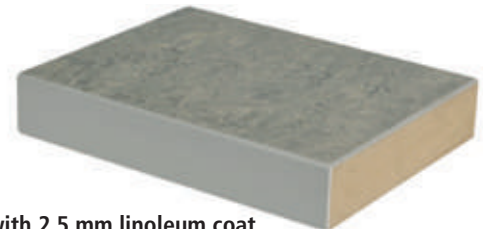

MDF worktop with 2.5 mm linoleum coat

- 4-sided ABS edging
- Antistatic
- Scratch resistant
- Made from purely natural raw materials, thus linoleum is very environmentally friendly in production, use and disposal
- Areas of application: technical, electrical and chemical works

Panel thickness (mm)	40	50
Dimensions in mm (WxD)	Item no.	Item no.
1250 x 750	L03.125.40	L03.125.50
1500 x 750	L03.15.40	L03.15.50
2000 x 750	L03.20.40	L03.20.50

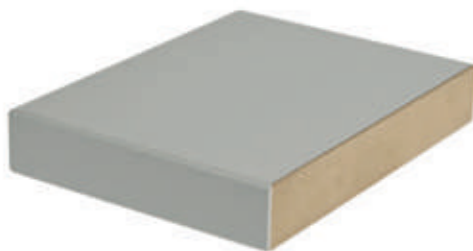

MDF worktop with 0.7 mm HPL coat

- 4-sided, ABS edging
- Heat and light resistant
- Stain-resistant, easy to clean and to disinfect
- Solvent resistant and largely chemical resistant

Panel thickness (mm)	40	50
Dimensions in mm (WxD)	Item no.	Item no.
1250 x 750	H03.125.40	H03.125.50
1500 x 750	H03.15.40	H03.15.50
2000 x 750	H03.20.40	H03.20.50

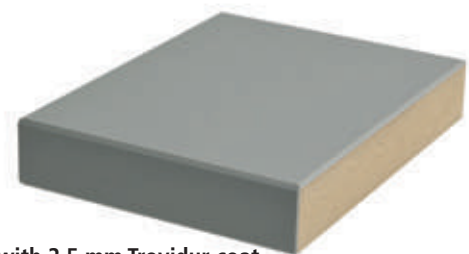

MDF worktop with 2.5 mm Trovidur coat

- 4-sided ABS edging
- Low flammability surface
- Very good electrical insulating properties
- High resistance to acids, lyes and salt solutions
- Areas of application: Chemical tank and plant construction, electrical industry, construction industry

Panel thickness (mm)	40	50
Dimensions in mm (WxD)	Item no.	Item no.
1250 x 750	T03.125.40	T03.125.50
1500 x 750	T03.15.40	T03.15.50
2000 x 750	T03.20.40	T03.20.50

Ergonomics at the workplace

A workplace that individually adapts to the respective worker's height. Optimal working conditions for a seated and standing workplace. Beech multiplex worktop 40 mm.



You can find further accessories on/from page 398



powerline C heavy load table with stand

- powerline heavy load table electrically height-adjustable
- Stand structure
- 1x pivot arm with perforated/slotted walls
- 1x pivot arm with shelf and ribbed rubber mat
- 1x halogen lamp
- 2x earthed sockets
- 1x 1/4" compress air connection

Item no.	Dimensions in mm (WxDxH)
CF.125.75-2	1250 x 750 x 745 – 1195
CF.150.75-2	1500 x 750 x 745 – 1195
CF.200.75-2	2000 x 750 x 745 – 1195

powerline C heavy load table with multi-board setup

- 2x support column
- 1x energy bar with 3x earthed sockets and on/off switch
- 1x perforated wall
- 1x magnetic board
- 1x shelf, 320 mm
- 1x overhead frame
- 1x equipment rail
- 1 x LED illumination 28.9 W, 1290 lx

Item no.	Dimensions in mm (WxDxH)
CF.125.75-1	1250 x 750 x 745 – 1195
CF.150.75-1	1500 x 750 x 745 – 1195
CF.200.75-1*	2000 x 750 x 745 – 1195

Supplied without hooks, boxes and decoration

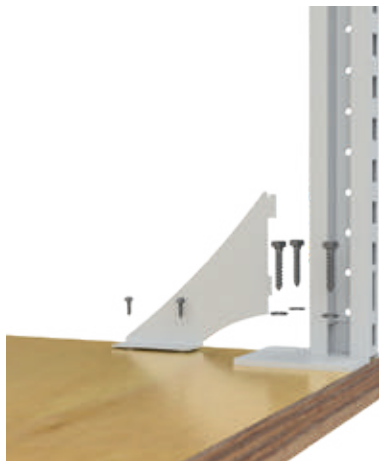

- Table width 2000 mm
- Superstructure width centre-centre 2 x 950 mm
- 2x support column left
- 2x support column right

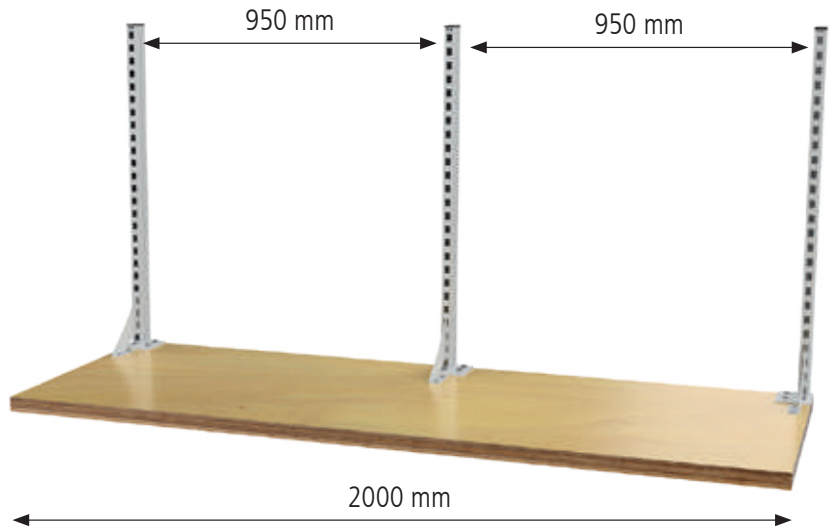

i *Three support columns are required for a table width of 2000 mm.
The number of perforated walls, magnetic boards and shelves doubles.



Attachments for the stand

- Attachment for powerline, for example
- Screwed to the worktop (40 mm)

Item no.
07.40.016

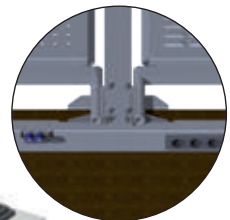

Multiple socket bar, single

- With 4 sockets
- Attachment under the worktop, for example

Item no.	Designation
07.40.03	840 x 110 x 45 Multiple socket bar
07.40.04	1/4" compressed air connection

powerline 4



powerline 4 - the strongest one

Thanks to its electric height adjustment, the **powerline** moves virtually silently to the required working height in a range of 705-1155 mm. The vertical travel speed is 9 mm/s without load. Thus, the powerline creates a flexible seated/standing workplace without long waiting times. The 4-foot variant boasts a load capacity of up to 900 kg.

- Feet with levelling
- **Drive:** Internal DC drive with built-in end switches and two synchronous Hall effect sensors
- **Connection:** 230 V | **Drive motor:** 24 V

**Features at a glance**

Retrofittable	Multi-board setup or stand and optional accessories such as foot switch
Energy	Direct supply of lighting, energy, compressed air
Frame widths	1500, 2000 mm
Frame depth	900 mm
Travel speed	9 mm/s without load
Work height without worktop	705 – 1155 mm Vertical travel: 450 mm
Height adjustment	Electric height adjustment
Frame design	4-foot
Load capacity	900 kg with even load

FRAME DESIGN:**HEIGHT ADJUSTMENT:**

Electric height adjustment



powerline 4 basic frame

- Equipped with manual switch for height adjustment as standard
- Lifting columns made of aluminium
- Frame and feet made of rectangular tube and 5 mm thick sheet steel

Item no.	Dimensions in mm (WxDxH)
4F.150.75	1500 x 750 x 705 – 1155
4F.150.90	1500 x 900 x 705 – 1155
4F.200.75	2000 x 750 x 705 – 1155
4F.200.90	2000 x 900 x 705 – 1155



powerline 4 basic table

- Beech multiplex top 40 mm
- Equipped with manual switch for height adjustment as standard
- Lifting columns made of aluminium
- Frame and feet made of rectangular tube and 5 mm thick sheet steel

Item no.	Dimensions in mm (WxDxH)
4F.150.75BM	1500 x 750 x 745 – 1195
4F.150.90BM	1500 x 900 x 745 – 1195
4F.200.75BM	2000 x 750 x 745 – 1195
4F.200.90BM	2000 x 900 x 745 – 1195

You can find further worktops on/from page 422



Beech multiplex workbench top

- Glue laminated, oiled
- Waterproof
- Dampened according to DIN 68705

Panel thickness (mm)	40	50
Dimensions in mm (WxD)	Item no.	Item no.
1500 x 750	03.15.40	03.15.50
1500 x 900	03.1590.40	03.1590.50
2000 x 750	03.20.40	03.20.50
2000 x 900	03.2090.40	03.2090.50



Chipboard panel directly coated with melamine resin

- 4-sided, ABS edging
- Chipboard carrier plate with direct coating
- Abrasion-resistant and easy to care for surface

Panel thickness (mm)	40	50
Dimensions in mm (WxD)	Item no.	Item no.
1500 x 750	07.M1575.40	07.M1575.50
1500 x 900	07.M1590.40	07.M1590.50
2000 x 750	07.M2075.40	07.M2075.50
2000 x 900	07.M2090.40	07.M2090.50



Red beech workbench top

- Strip laminated
- Finger jointed
- Glued wood panel with distinctive grain

Panel thickness (mm)	40	50
Dimensions in mm (WxD)	Item no.	Item no.
1500 x 750	03.15.40RB	03.15.50RB
1500 x 900	03.1590.40RB	03.1590.50RB
2000 x 750	03.20.40RB	03.20.50RB
2000 x 900	03.2090.40RB	03.2090.50RB

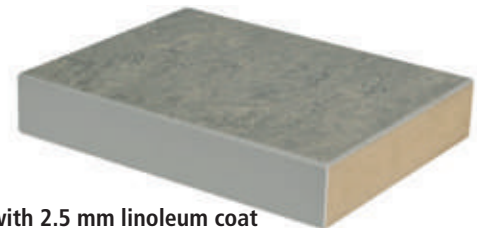

MDF worktop with 2.5 mm linoleum coat

- 4-sided ABS edging
- Antistatic
- Scratch resistant
- Made from purely natural raw materials, thus linoleum is very environmentally friendly in production, use and disposal
- Areas of application: technical, electrical and chemical works

Panel thickness (mm)	40	50
Dimensions in mm (WxD)	Item no.	Item no.
1500 x 750	L03.15.40	L03.15.50
1500 x 900	L03.1590.40	L03.1590.50
2000 x 750	L03.20.40	L03.20.50
2000 x 900	L03.2090.40	L03.2090.50



MDF worktop with 0.7 mm HPL coat

- 4-sided, ABS edging
- Heat and light resistant
- Stain-resistant, easy to clean and to disinfect
- Solvent resistant and largely chemical resistant

Panel thickness (mm)	40	50
Dimensions in mm (WxD)	Item no.	Item no.
1500 x 750	H03.15.40	H03.15.50
1500 x 900	H03.1590.40	H03.1590.50
2000 x 750	H03.20.40	H03.20.50
2000 x 900	H03.2090.40	H03.2090.50

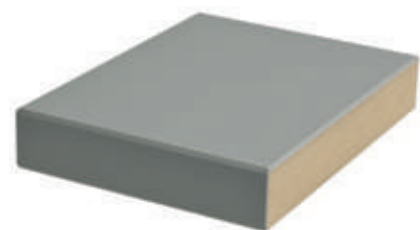

MDF worktop with 2.5 mm Trovidur coat

- 4-sided ABS edging
- Low flammability surface
- Very good electrical insulating properties
- High resistance to acids, lyes and salt solutions
- Areas of application: Chemical tank and plant construction, electrical industry, construction industry

Panel thickness (mm)	40 mm	50
Dimensions in mm (WxD)	Item no.	Item no.
1500 x 750	T03.15.40	T03.15.50
1500 x 900	T03.1590.40	T03.1590.50
2000 x 750	T03.20.40	T03.20.50
2000 x 900	T03.2090.40	T03.2090.50

Ergonomics at the workplace

A workplace that individually adapts to the respective worker's height. Optimal working conditions for a seated and standing workplace. Beech multiplex worktop 40 mm.



PL

i *Three support columns are required for a table width of 2000 mm. The number of perforated walls, magnetic boards and shelves doubles.

You can find further accessories on/from page 298



powerline 4 with multi-board setup

- 2x support column
- 1x energy bar with 3x earthed sockets and on/off switch
- 1x perforated wall
- 1x magnetic board
- 1x shelf, 320 mm
- 1x overhead frame
- 1x equipment rail
- 1 x LED illumination 28.9 W, 1290 lx

Item no.	Dimensions in mm (WxDxH)
4F.150.75-1	1500 x 750 x 745 – 1195
4F.150.90-1	1500 x 900 x 745 – 1195
4F.200.75-1*	2000 x 750 x 745 – 1195
4F.200.90-1*	2000 x 900 x 745 – 1195

powerline 4 with multi-board setup

- 2x support column
- 1x energy bar with 3x earthed sockets and on/off switch
- 2x 1/4" compressed air connection
- 1x shelf, 220 mm
- 1x perforated wall
- 1x magnetic board
- 1x pivot arm with platform
- 1x overhead frame
- 1x equipment rail
- 1 x LED illumination 28.9 W, 1290 lx

Item no.	Dimensions in mm (WxDxH)
4F.150.75-2	1500 x 750 x 745 – 1195
4F.150.90-2	1500 x 900 x 745 – 1195
4F.200.75-2*	2000 x 750 x 745 – 1195
4F.200.90-2*	2000 x 900 x 745 – 1195

Supplied without hooks, boxes and decoration



i *Three support columns are required for a table width of 2000 mm. The number of perforated walls, magnetic boards and shelves doubles.

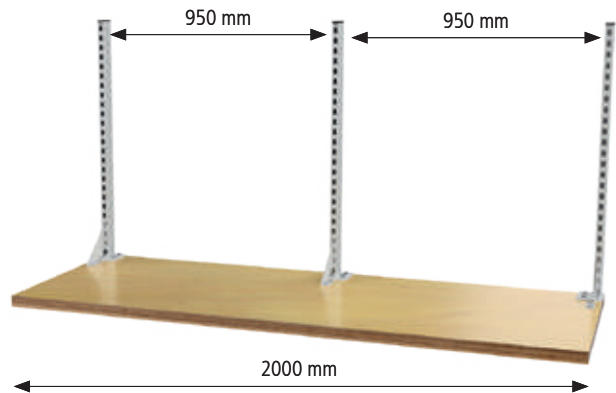

powerline 4 with multi-board setup

- 2x support column
- 1x energy bar with 3x earthed sockets and on/off switch
- 3x shelf, 220 mm depth
- 1x shelf, 320 mm depth
- 1x overhead frame
- 1x equipment rail
- 1 x LED illumination 28.9 W, 1290 lx

powerline 4 with multi-board setup

- 2x support column
- 1x energy bar with 3x earthed sockets and on/off switch
- 1x perforated wall
- 1x magnetic board
- 2x shelf, 320 mm
- 1x overhead frame
- 2x equipment rail
- 1 x LED illumination 28.9 W, 1290 lx
- 1x carriage

Item no.	Dimensions in mm (WxDxH)
4F.150.75-3	1500 x 750 x 745 – 1195
4F.150.90-3	1500 x 900 x 745 – 1195
4F.200.75-3*	2000 x 750 x 745 – 1195
4F.200.90-3*	2000 x 900 x 745 – 1195

Item no.	Dimensions in mm (WxDxH)
4F.150.75-4	1500 x 750 x 745 – 1195
4F.150.90-4	1500 x 900 x 745 – 1195
4F.200.75-4*	2000 x 750 x 745 – 1195
4F.200.90-4*	2000 x 900 x 745 – 1195

Supplied without hooks, boxes and decoration



hydline heavy load table

Item no.	Dimensions in mm (WxDxH)	Description
03.15.40.07	1500 x 750 x 700 – 1100	Complete set, as illustrated, but without decoration, spring balancer, boxes and tools, without lighting
03.15.40HVS	1500 x 750 x 700 – 1100	hydline heavy load table with electric height adjustment
07.40.016		Attachments for the stand, screwed to the worktop (40 mm)
07.40.06		Stand structure with 2x earthed sockets and 1x halogen lightning 35W
07.40.07		Surcharge for 1/4" compressed air distributor
07.98.10	655 x 45 x 500	Pivot arm with perforated/slotted wall
07.00.30	740 x 410 x 430	Footrest, with individually adjustable height and incline
05.96.09	520-710	PU standing aid, blue, large PU seat, blue, 370 mm wide Seat incline adjustment, 7.5° forwards and backwards, seat height adjustment with gas spring, stable plastic-cruciform base, Ø 630 mm
04.10.05V-1	555 x 736 x 1005	Mobile drawer cabinet, 2x 100 mm drawer, 2x 150 mm drawer, 1x 200 mm drawer, drawers with full pull-out 100 %, load capacity 100 kg, central locking with individual pull-out lock, double locking of the drawers with single locks, 2x steering casters with locks, 2x fixed casters Ø 125 mm, beech multiplex worktop 25 mm

hydline - the quickest of the strong ones

The **hydline** heavy load table moves to your required working height at a speed of 15 mm/s. However, this table is not only quick, but also strong. The hydline has a load capacity of up to 600 kg. Thanks to the hydraulic drive, it has a long service life and will be your trusty companion for a long time.

- Stepless height adjustment of the drive
- Very large forces and torques
- Pressure relief valve for reliable and quick-acting overload protection
- High power density in comparison with electric motors
- Implementation of linear drive elements working in parallel
- Long service life thanks to the hydraulic drive
- High positioning accuracy
- Uniform movement

**Features at a glance**

Retrofittable	Multi-board setup or stand and optional accessories such as foot switch
Energy	Direct supply of lighting, energy, compressed air
Frame widths	1500, 2000 mm
Frame depth	750 mm
Travel speed	15 mm/s without load
Work height without worktop	705 – 1155 mm Vertical travel: 450 mm
Height adjustment	Two different types: Crank adjustment, electric height adjustment
Frame design	H-foot
Load capacity	350-600 kg with uniform load depending on height adjustment

hL
EH

FRAME DESIGN:**HEIGHT ADJUSTMENT:**

Crank adjustment



Electric height adjustment



Ergonomics at the workplace

A workplace that individually adapts to the respective worker's height. Optimal working conditions for a seated and standing workplace. Beech multiplex worktop 40 mm.



Multi-board setup

- 2x support column
- 1x overhead frame
- 1x equipment rail
- 1x LED illumination 28.9 W, 1290 lx
- 1x energy bar with 3x earthed sockets and on/off switch
- 2x 1/4" compressed air connection
- 1x perforated wall
- 1x magnetic board
- 1x shelf, 320 mm

Item no.	Dimensions in mm (WxDxH)	Description
03.900.15.20	1500 x 750 x 1250	Multi-board setup
03.15.40HV	1500 x 750 x 700 – 1100	hydline heavy load table with crank adjustment, 350 kg load capacity
03.15.40HVS	1500 x 750 x 700 – 1100	hydline heavy load table height-adjustable with electric control, 600 kg load capacity

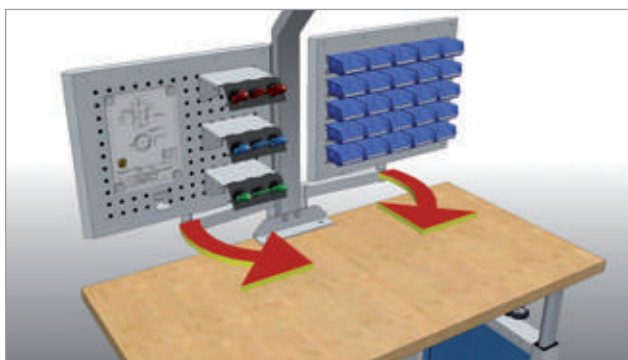

Adjustable pivot arms ensure the free configuration of handling areas

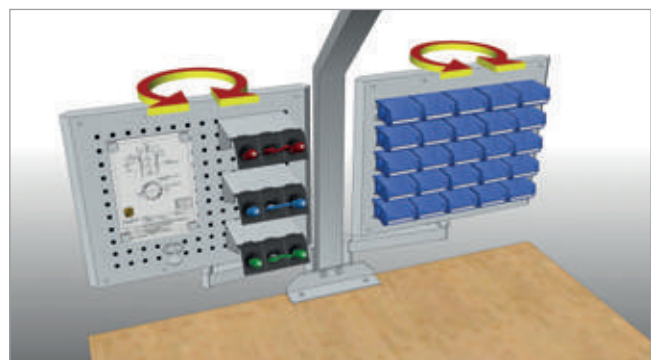

360° pivot arm inserts, which are attached directly to the stand, offer maximum flexibility for the work to be carried out.

You can find multi-board setups on/ from page 265

New



Floor anchorage

- For fixing the workbench to the floor
- 4 pieces

Item no.
03.00.34



kg
350

hL

1

hydline heavy load table

- Crank adjustment
- Maximum load capacity 350 kg

Item no.	Dimensions in mm (WxDxH)	Tabletop	Thickness in mm
03.15.40HV	1500 x 750 x 700 – 1100	Multiplex	40
03.15.50HV	1500 x 750 x 700 – 1100	Multiplex	50
H03.15.40HV	1500 x 750 x 700 – 1100	MDF – HPL	40
H03.15.50HV	1500 x 750 x 700 – 1100	MDF – HPL	50
03.20.40HV	2000 x 750 x 700 – 1100	Multiplex	40
03.20.50HV	2000 x 750 x 700 – 1100	Multiplex	50
H03.20.40HV	2000 x 750 x 700 – 1100	MDF – HPL	40
H03.20.50HV	2000 x 750 x 700 – 1100	MDF – HPL	50



kg
600

hL

2

hydline heavy load table

- Hydraulically height-adjustable with electric control
- Maximum load capacity 600 kg

Item no.	Dimensions in mm (WxDxH)	Tabletop	Thickness in mm
03.15.40HVS	1500 x 750 x 700 – 1100	Multiplex	40
03.15.50HVS	1500 x 750 x 700 – 1100	Multiplex	50
H03.15.40HVS	1500 x 750 x 700 – 1100	MDF – HPL	40
H03.15.50HVS	1500 x 750 x 700 – 1100	MDF – HPL	50
03.20.40HVS	2000 x 750 x 700 – 1100	Multiplex	40
03.20.50HVS	2000 x 750 x 700 – 1100	Multiplex	50
H03.20.40HVS	2000 x 750 x 700 – 1100	MDF – HPL	40
H03.20.50HVS	2000 x 750 x 700 – 1100	MDF – HPL	50



Freely adjustable system lights, which are attached directly to the stand.



Sockets, compressed air connections and a halogen lamp are integrated into the stand. This saves the space an additional energy bar would require.



You can find further accessories on/from page 284



Attachments for the stand

- Screwed to the worktop (40 mm)

Item no.
07.40.016



Stand

- For structures with 2x earthed sockets and 1x halogen lightning 35 W

Item no.	Design
07.40.06	Standard
07.40.07	Surcharge for 1/4" compressed air distributor

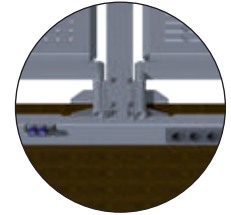

Multiple socket bar, single

- With 4 sockets
- Attachment under the worktop, for example

Item no.	Designation
07.40.03	840 x 110 x 45 Multiple socket bar
07.40.04	1/4" compressed air connection



Please note:

- The stand or the attachment for the stand is required for the pivot arms
- Load capacity 30 kg

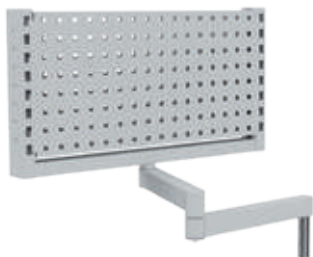

Pivot arm with pivot frame and perforated walls

- With double-sided perforated wall

Item no.	Dimensions in mm (WxDxH)
07.98.09	680 x 60 x 350



Pivot arm with perforated/slotted wall

- For hooks and small parts boxes
- 1st side with slotted wall | 2nd side with perforated wall

Item no.	Dimensions in mm (WxDxH)
07.98.10	655 x 45 x 500



Example application

Open fronted storage bins

- 15 pieces

Item no.	Dimensions in mm (WxDxH)
07.45.26	—



Pivot arm with shelf

- Beech multiplex 25 mm

Item no.	Dimensions in mm (WxD)
07.98.12	600 x 350



Pivot arm with depositing tray

Item no.	Dimensions in mm (WxDxH)
07.98.04	400 x 300 x 48



Pivot arm with document holder A4

- With raised lateral and bottom edge

Item no.	Dimensions in mm (WxDxH)
07.98.05	215 x 35 x 330

You can find further accessories on/from page 236



Carriage

Item no.	Designation
03.900.01	—



Spring balancer

- For all kinds of portable equipment and tools
- 1600 mm pull-out

Item no.	Load capacity in kg
03.900.44	0.4 – 1.0
03.900.45	1.0 – 2.0
03.900.46	2.0 – 3.0



Spring balancer with hose

- Max. pressure 8 bar
- Airflow 370 l/min
- Both sides R 1/4"
- 1400 mm pull-out

Item no.	Load capacity in kg
03.900.60	0.4 – 0.8
03.900.61	0.8 – 1.5
03.900.62	1.2 – 2.5



Bag holder

- For mounting on the worktop

Item no.	Dimensions in mm (WxDxH)
03.900.41	40 x 30 x 70



Bottle holder

- For mounting on the perforated wall and the worktop

Item no.	Dimensions in mm
03.900.43	Ø 90 x 70



Roll holder

- For mounting on the perforated wall and the worktop

Item no.	Dimensions in mm (WxDxH)
03.900.42	200 x 95 x 71



Range of hooks, 10 parts

- 7x tool holder with inclined end
- 2x double tool holder
- 1x tool clamp

Item no.
03.87.395-10



Double tool holder with slanted hook ends

- Ø 6 mm

Item no.	Dimension in mm (W)
03.87.322	50
03.87.323	75
03.87.324	150



Depositing box, small

Item no.	Dimensions in mm (WxDxH)
03.87.430	250 x 80 x 35



Other heavy load tables

Heavy load table

- Very stable steel tube construction, 80 x 80 x 3 mm
- Completely welded
- 2500 kg total load capacity
- Frame height 919 mm

You can find worktops
on/from page 422



Heavy load table frame

- Frame without worktop

Item no.	Dimensions in mm (WxDxH)
03.10SLT1.6	1000 x 650 x 919
03.15SLT1.6	1500 x 650 x 919
03.20SLT1.6	2000 x 650 x 919



Heavy load table

- Beech multiplex worktop 50 mm

Item no.	Dimensions in mm (WxDxH)
03.10SLT0.6	1000 x 750 x 969
03.15SLT0.6	1500 x 750 x 969
03.20SLT0.6	2000 x 750 x 969

Height-adjustable heavy load table

Heavy load tables

- Stable U-profile construction, 75 x 50 x 2 mm
- Welded and bolted with gusset plates for stiffening
- For assembly, workshop and shipping
- 1000 kg total load capacity
- Height-adjustable from 694 to 1044 mm on a grid of 25 mm



You can find worktops on/from page 422



Height-adjustable heavy load table frame

- Frame without worktop
- Height-adjustable on a grid of 25 mm

Item no.	Dimensions in mm (WxDxH)
03.10.001.6	1000 x 650 x 694 – 1044
03.15.001.6	1500 x 650 x 694 – 1044
03.20.001.6	2000 x 650 x 694 – 1044

New



Wooden shelf

- Beech multiplex

Item no.	Dimensions in mm (WxDxH)
03.10.001FB	900 x 550 x 25
03.15.001FB	1400 x 550 x 25
03.20.001FB	1900 x 550 x 25

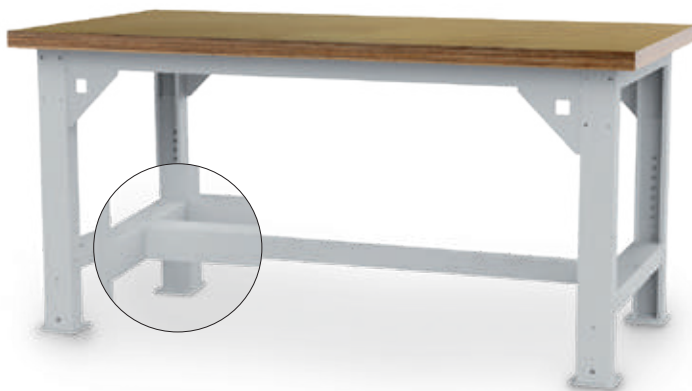

Height-adjustable heavy load table

- Beech multiplex worktop 40 mm
- Height-adjustable on a grid of 25 mm

Item no.	Dimensions in mm (WxDxH)
03.10.000.6	1000 x 750 x 734 – 1084
03.15.000.6	1500 x 750 x 734 – 1084
03.20.000.6	2000 x 750 x 734 – 1084



Mobile add-on for height-adjustable heavy load table

- Retrofittable
- Stable U-profile construction
- Height-adjustable on a grid of 25 mm
- Total height of heavy load table incl. casters: 884 – 1236 mm
- Load capacity 450 kg
- 4x steering caster, Ø 125 mm with lock



Item no.	Dimensions in mm (WxDxH)
03.90.HVMOB	1000 x 750 x 150

Delivered unassembled with assembly instructions



Other workplace systems

- they can handle it





New

Packing tables

Page 404



Cutting stands

Page 418



Stable table design with levelling

Page 419



workalu

Page 420





Packing tables - workplace systems

Packing tables

- Stable table design with levelling
- 19 mm worktop with melamine resin coating
- Surface loading up to 100 kg
- Shelves of table extensions made of galvanised sheet steel
- Cutting device with exchangeable cartridge
- Titanium coated blade
- High functionality
- Selected accessories



Pos.	Item no.	Dimensions in mm (W x D x H)	Description
1	03.PT01	2000 x 800 x 850	Packing table 2000, 19 mm worktop with melamine resin coating, max. surface loading up 100 kg
2	03.700030	40 x 40 x 1266	Mounting beam, in pairs
3	03.PT06	1430 x 400 x 58	Tray made of galvanised sheet steel, for mounting between the beams
4	03.700050	1420 x 300 x 400	Add-on store made of galvanised sheet steel incl. 8x dividers, max. surface loading 50 kg
5	03.700140	1425 x 20 x 20	Axle between beams, for holding rolls, max. load capacity 20 kg
6	03.700120	513 x 530 x 160	Drawer made of sheet steel, lockable, load capacity 12.5 kg
7	03.PT13	1500 x 175 x 20	Attachment cutting device, cutting width 1250 mm, incl. axle set
8	03.PT14	600 x 600 x 750	Side table, max. Area load 100 kg
9	03.700080	1415 x 300 x 415	Base box store, incl. 8x divider, mobile with 4x lockable steering caster
10	03.897052	500 x 400	Digital table scales for weighings not subject to statutory calibration
no fig.	03.PT02	1600 x 800 x 850	Packing table 1600, 19 mm worktop with melamine resin coating, max. surface loading up 100 kg
no fig.	03.PT05	1435 x 253 x 114	Form tray made of galvanised sheet steel
no fig.	03.PT08	1525 x 650 x 19	Intermediate shelf, wood, max. surface loading 50 kg
no fig.	03.PT12	200 x 100 x 100	Monitor mount, VESA 75/100 mm
no fig.	03.PT17	600 x 490 x 675	Drawer unit incl. 4x drawer, mobile
no fig.	03.PT509201	640 x 728 x 120	Keyboard and mouse tray with articulated arm



Complete packing station with 1600 mm wide tabletop

- Form tray, 230 mm depth
- Box store with 6x divider
- Stable table with steel construction
- 300 kg surface loading
- Light grey 30 mm worktop with melamine resin coating
- Steel parts powder-coated, RAL 7016 Anthracite grey and RAL 3003 Ruby red
- Intermediate shelf (1145 x 650 x 19 mm)
- Steel drawer (520 x 500 x 150 mm), 12.5 kg load capacity

Item no.	Cutting width/dimensions in mm (W x D x H)
03.PT163001	1600 x 800 x 690 – 960



Complete packing station with 1600 mm wide tabletop

- Form tray, 230 mm depth
- Box store with 6x divider
- Stable table with steel construction
- 300 kg surface loading
- Light grey 30 mm worktop with melamine resin coating
- Steel parts powder-coated, RAL 7016 Anthracite grey and RAL 3003 Ruby red
- Cutting device, RAL 9007 Grey aluminium, with blade cartridge for paper and foils, cutting width 100 cm, axle set with cones and bearing shells

Item no.	Cutting width/dimensions in mm (W x D x H)
03.PT163002	1600 x 800 x 690 – 960



Packing tables - workplace systems

Packing tables



Crank adjustment



Electric height adjustment



Packing and worktable 1600/2000

- Stable steel construction, beams and feet made of square tube
- Foldable for transport, height adjustable from 690 to 960 mm as standard, melamine coated 30 mm tabletop
- Max. surface loading 300 kg
- Steel parts powder-coated, RAL 7016 Anthracite grey and RAL 3003 Ruby red
- Other versions with scales and EDP interface available

Pos.	Item no.	Dimensions in mm (W x D x H)	Design
1	03.PT163000	1600 x 800 x 690-960	Clamp fixing
	03.PT203000	2000 x 920 x 690-960	Clamp fixing
	03.PT163500	1600 x 800 x 710-960	Crank adjustment
	03.PT203500	2000 x 920 x 710-960	Crank adjustment
	03.PT163800	1600 x 800 x 710-960	Electric height adjustment
	03.PT203800	2000 x 920 x 710-960	Electric height adjustment

Accessories for table width 1600 mm

Pos.	Item no.	Dimensions in mm (W x D x H)	Description
2	03.PT166000	1600 x 40 x 40	Back board made of 40 x 40 mm square tube
4	03.PT1653	1015 x 600 x 400	Add-on store, dividers: 3x small divider, 3x large divider, flexible clamp mounting, max. surface loading 50 kg
	03.PT1653D	1015 x 600 x 400	Add-on store without dividers, e.g. for mounting of the printer pull-out, flexible clamp mounting, max. surface loading 50 kg
5	03.PT207004	661 x 51 x 54	Workplace lighting, LED with dimming function, rotatable, 21 W, 903 lux
	03.PT207002	1145 x 515 x 40	Holder for mounting the workplace lamp, for mounting under add-on store
6	03.PT160900	1135 x 650 x 19	Intermediate shelf, max. surface loading 50 kg
7	03.PT704700	1045 x 450 x 60	Inclined sheet steel tray, flexible clamp mounting, incline continuously adjustable, with raised edge, max. surface loading 50 kg
9	03.PT704740	1046 x 400	Tray, melamine resin coated wooden panel, 30 mm, flexible clamp mounting, max. surface loading 50 kg

Accessories for table width 2000 mm

Pos.	Item no.	Dimensions in mm (W x D x H)	Description
2	03.PT206000	2000 x 40 x 40	Back board made of 40 x 40 mm square tube
4	03.PT2053	1600 x 600 x 400	Add-on store, dividers: 5x small divider, 4x large divider, flexible clamp mounting, max. surface loading 50 kg
	03.PT2053D	1600 x 600 x 400	Add-on store without dividers, e.g. for mounting of the printer pull-out, flexible clamp mounting, max. surface loading 50 kg
5	03.PT207003	976 x 51 x 54	Workplace lighting, LED with dimming function, rotatable, 32 W, 1409 lux
	03.PT207001	1730 x 515 x 40	Holder for mounting the workplace lamp, for mounting under add-on store
6	03.PT200900	1720 x 770 x 19	Intermediate shelf, max. surface loading 50 kg
7	03.PT704800	1630 x 450 x 60	Inclined sheet steel tray, flexible clamp mounting, incline continuously adjustable, with raised edge, max. surface loading 50 kg
9	03.PT704750	1600 x 400	Tray, melamine resin coated wooden panel, 30 mm, flexible clamp mounting, max. surface loading 50 kg

The mounting beams or the add-on frame are the basis for all above-the-table-accessories.
Please note the matching accessories for table widths 1600 and 2000 mm.

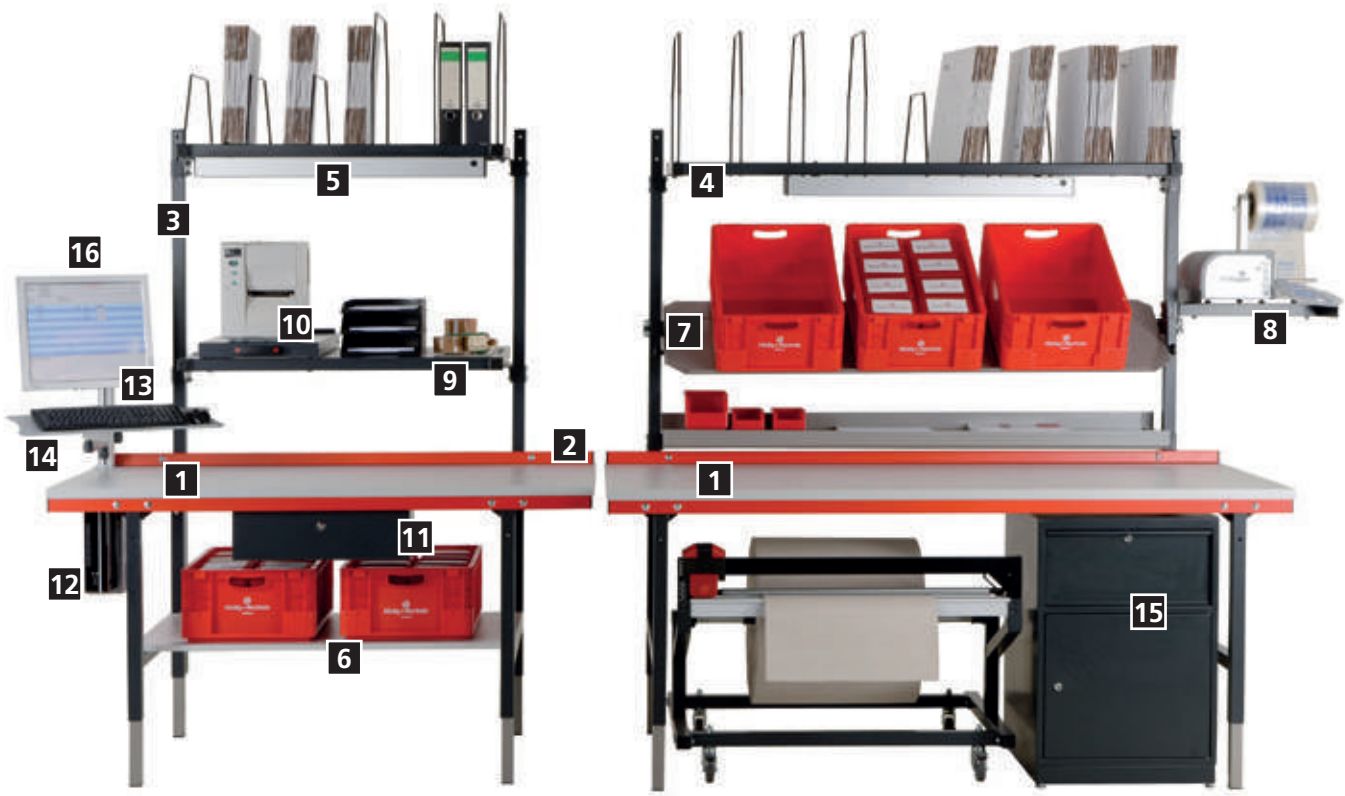

Accessories for table widths 1600 and 2000 mm

Pos.	Item no.	Dimensions in mm (W x D x H)	Description
3	03.PT2062	1170	Mounting beams, short version, 485 mm above tabletop with screw fastening at table legs, PU = 2 pieces, for table 03.PT163000 and 03.PT203000
3	03.PT2064	1770	Mounting beams, long version, 1085 mm above tabletop with screw fastening at table legs, PU = 2 pieces, for table 03.PT163000 and 03.PT203000
3	03.PT2065	1170	Mounting beams, short version, 485 mm above tabletop with screw fastening at table legs, PU = 2 pieces, for table 03.PT16350, 03.PT203500, 03.PT163800 and 03.PT203800
3	03.PT2066	1770	Mounting beams, long version, 1085 mm above tabletop with screw fastening at table legs, PU = 2 pieces, for table 03.PT16350, 03.PT203500, 03.PT163800 and 03.PT203800
8	03.PT2082	440 x 520 x 90	Universal tray for monitor, adhesive tape dispenser, etc. Clamp mounting at beams, max. surface loading 25 kg
10	03.PT205350	375 x 658 x 100	Printer pull-out for mounting on add-on store
11	03.PT200600	520 x 500 x 150	Steel drawer, lockable, for right and/or left use under table, plastic sliding guide, with protection against slipping out, load capacity 35 kg, internal dimensions: 460 x 495 x 120
12	03.PT228100	100 – 242 x 150 x 320 – 545	PC support for mounting under packing table, incl. fixing screws and drilling template
	03.PT228101	130 x 240 x 120	Beam attachment for PC holder
13	03.PT509001	51 x 51 x 445	Support column with screw clamps for attachment of an articulated TFT monitor arm and a keyboard tray, aluminium profile with clamp fastening, 14 – 40 mm clamping range
	03.PT509002	51 x 51 x 445	Support column with screw clamps for attachment of an articulated TFT monitor arm and a keyboard tray, aluminium profile with clamp fastening, 5 – 65 mm clamping range
	03.PT509006	51 x 51 x 845	Support column with screw clamps for attachment of an articulated TFT monitor arm and a keyboard tray, aluminium profile with clamp fastening, 5 – 65 mm clamping range
14	03.PT509201	640 x 728 x 120	Keyboard and mouse tray with articulated arm for flexible attachment to support column or adapter, surface area: 640 x 172mm, load capacity 10 kg
15	03.PT20	535 x 600 x 785	Cabinet unit with 1x door, 1x drawer
16	03.509204	47 x 67 x 200	Adapter for pivot arm and support carriage



Packing tables - workplace systems

Packaging table basic

- Sturdy construction made of 40 x 40 mm square tube
- Top front additional square tube beam
- Top rear stiffening plate for stabilisation
- Worktop optionally:
 - Beech multiplex, glue laminated, oiled or
 - MDF worktop with 0.7 mm HPL coat, 4-sided ABS edging
- Leveling glides under the feet
- Load capacity 300 kg
- Delivery unassembled



New



Basic table depth 750

Item no.	Dimensions in (W x D x H)	Worktop
PT1575BU	1500 x 750 x 859	Beech multiplex
PT2075BU	2000 x 750 x 859	Beech multiplex
PT1575HPL	1500 x 750 x 859	MDF with HPL coat
PT2075HPL	2000 x 750 x 859	MDF with HPL coat

Basic table depth 900 mm

Item no.	Dimensions in (W x D x H)	Worktop
PT1590BU	1500 x 900 x 859	Beech multiplex
PT2090BU	2000 x 900 x 859	Beech multiplex
PT1590HPL	1500 x 900 x 859	MDF with HPL coat
PT2090HPL	2000 x 900 x 859	MDF with HPL coat

Height adjustment

- Height-adjustable on a grid of 25 mm
- Complete for a workbench with 4 feet

Item no.	Version
03.15.95	Height adjustment of 200 mm
03.15.96	Height adjustment of 300 mm



- Construction made of 45 x 45 mm square tube
- Feet made of Aluminium profiles 40 x 40 mm
- Worktop optionally:
 - Beech multiplex, glue laminated, oiled or
 - MDF worktop with 0.7 mm HPL coat, 4-sided ABS edging
- Travel speed 12 mm/s
- 4 different types of height adjustment:
 - Clamp fixing, load capacity 200 kg
 - Crank adjustment, load capacity 200 kg
 - Electric height adjustment with 1 motor, load capacity 180 kg
 - Electric height adjustment with 2 motors, load capacity 300 kg
- Delivery unassembled

 New

Basic table depth 750 mm

- Dimensions in mm (W x D x H): 1500 x 750 x 710-1055 mm

Item no.	Height adjustment	Worktop
PT4150KL75B	Clamp fixing	Beech multiplex
PT4150KU75B	Crank adjustment	Beech multiplex
PT4150E175B	Electric with 1 motor	Beech multiplex
PT4150E275B	Electric with 2 motors	Beech multiplex
PT4150KL75H	Clamp fixing	MDF with HPL coat
PT4150KU75H	Crank adjustment	MDF with HPL coat
PT4150E175H	Electric with 1 motor	MDF with HPL coat
PT4150E275H	Electric with 2 motors	MDF with HPL coat

Basic table depth 900 mm

- Dimensions in mm (W x D x H): 1500 x 900 x 710-1055 mm

Item no.	Height adjustment	Worktop
PT4150KL90H	Clamp fixing	MDF with HPL coat
PT4150KU90H	Crank adjustment	MDF with HPL coat
PT4150E190H	Electric with 1 motor	MDF with HPL coat
PT4150E290H	Electric with 2 motors	MDF with HPL coat
PT4150KL90B	Clamp fixing	Beech multiplex
PT4150KU90B	Crank adjustment	Beech multiplex
PT4150E190B	Electric with 1 motor	Beech multiplex
PT4150E290B	Electric with 2 motors	Beech multiplex

Basic table depth 750 mm

- Dimensions in mm (W x D x H): 2000 x 750 x 710-1055 mm

Item no.	Height adjustment	Worktop
PT4200KL75B	Clamp fixing	Beech multiplex
PT4200KU75B	Crank adjustment	Beech multiplex
PT4200E175B	Electric with 1 motor	Beech multiplex
PT4200E275B	Electric with 2 motors	Beech multiplex
PT4200KL75H	Clamp fixing	MDF with HPL coat
PT4200KU75H	Crank adjustment	MDF with HPL coat
PT4200E175H	Electric with 1 motor	MDF with HPL coat
PT4200E275H	Electric with 2 motors	MDF with HPL coat

Basic table depth 900 mm

- Dimensions in mm (W x D x H): 2000 x 900 x 710-1055 mm

Item no.	Height adjustment	Worktop
PT4200KL90H	Clamp fixing	MDF with HPL coat
PT4200KU90H	Crank adjustment	MDF with HPL coat
PT4200E190H	Electric with 1 motor	MDF with HPL coat
PT4200E290H	Electric with 2 motors	MDF with HPL coat
PT4200KL90B	Clamp fixing	Beech multiplex
PT4200KU90B	Crank adjustment	Beech multiplex
PT4200E190B	Electric with 1 motor	Beech multiplex
PT4200E290B	Electric with 2 motors	Beech multiplex



Packing tables - workplace systems



Combination with packaging table basic, width 2000 mm

POS	Item no.	Dimensions in mm (W x D x H)	Description
1	PT2075BU	2000 x 750 x 859	Packaging table basic, depth 750 mm, worktop beech multiplex 40 mm
2	03.935.125.240	H 1250	Support column 30 x 60 mm, left
	03.935.125.140	H 1250	Support column 30 x 60 mm, right
3	03.935.TR10L	1000	Crossbar, left, 1000 mm
4	03MONHAL	125 x 125 x 121	Monitor mount, is attached to the crossbar
5	03.910.320	1000 x 320 x 20	Shelf, Inclination 0,10 and 20°
6	03.910.220	1000 x 220 x 20	Shelf, Inclination 0,10 and 20°
7	PT10ROHAMW	1000 x 32	Unwind holder incl. mounting, without paper roll
8	PTTAAUFB320	598 x 300 x 95	Keyboard pull-out beneath shelf, for shelves depth 320 mm
9	07.89.06	250 x 550 x 500	PC holder H, for fixing under the worktop, adjustable width
10	PTFBXXXXMML50	900 x 650 x 100/515	Trolley with 5 dividers for cardboard boxed, 4 steering rollers with lock Ø 50 mm, load capacity 120 kg, retrofittable

New

Other workplace systems

**Support column profile 30 x 60 mm**

- Reinforced by U-profile tube
- Thinner plate thicknesses on request
- Three support columns are required for installation on 2 m work surfaces
- Left column is also used as centre column

Item no.	Dimensions in mm
03.935.650.240	650 left
03.935.650.140	650 right
03.935.950.240	950 left
03.935.950.140	950 right
03.935.125.240	1250 left
03.935.125.140	1250 right

**Shelf depth 220 mm**

Item no.	Dimensions in mm (W x D x H)	Usable dimensions in mm (W x D)
03.910.220	1000 x 220 x 20	914 x 218
03.915.220	1500 x 220 x 20	1414 x 218
03.920.220	2000 x 220 x 20	1864 x 218

Shelf depth 320 mm

Item no.	Dimensions in mm (W x D x H)	Usable dimensions in mm (W x D)
03.910.320	1000 x 320 x 20	914 x 318
03.915.320	1500 x 320 x 20	1414 x 318
03.920.320	2000 x 320 x 20	1864 x 318

Shelf depth 420 mm

Item no.	Dimensions in mm (W x D x H)	Usable dimensions in mm (W x D)
03.910.420	1000 x 420 x 20	914 x 418
03.915.420	1500 x 420 x 20	1414 x 418
03.920.420	2000 x 420 x 20	1864 x 418

**Keyboard pull-out beneath shelf**

- For shelf depth 320 and 420 mm

Item no.	Dimensions in mm (W x D x H)
PTTAAUFB320	598 x 300 x 95

**Unwind holder, axis Ø 32 mm**

Item no.	Width in mm
PT10ROHAMW	1000
PT15ROHAMW	1500

**Crossbar**

Item no.	Version
03.935.TR10L	1000 mm, left
03.935.TR100	1000 mm, right
03.935.TR150	1500 mm
03.935.TR200D	2000 mm

**Monitor mount**

- For attachment to the crossbar

Item no.	Dimensions in mm (W x D x H)
03MONHAL	125 x 121 x 125



New



Combination with packaging table basic, width 1500 mm

POS	Item no.	Dimensions in mm (W x D x H)	Description
1	PT1575BU	1500 x 750 x 859	Packaging table basic, depth 750 mm, worktop beech multiplex 40 mm
2	03.935.125.240	H 1250	Support column 30 x 60 mm, left
	03.935.125.140	H 1250	Support column 30 x 60 mm, right
3	03.915.320	1500 x 320 x 20	Shelf, depth 320 mm
4	03.915.420G	1500 x 420	Shelf, perforated, for mounting between support columns
5	03.PT2956	H 250 mm	Bracket for shelf depth für 420mm
	03.PT2957	H 450 mm	Bracket for shelf depth für 420mm
6	PT15ETHAMW	1500	Holder for label rolls
7	03.2018-02D	1383 x 735 x 40	Steel shelf, full depth

Neu

Other workplace systems

Support column profile 30 x 60 mm

- Reinforced by U-profile tube
- Thinner plate thicknesses on request
- Three support columns are required for installation on 2 m work surfaces
- Left column is also used as centre column

Item no.	Dimensions in mm
03.935.650.240	650 left
03.935.650.140	650 right
03.935.950.240	950 left
03.935.950.140	950 right
03.935.125.240	1250 left
03.935.125.140	1250 right

**Shelf, perforated, for mounting between support columns**

- Suitable for the use of brackets
- Adjustable in inclination and height
- Inclination 0°, 10° und 20°, inkl. Abrollrand
- Incl. mounting

Item no.	Dimensions in mm (W x D)
03.910.420G	1000 x 420
03.915.420G	1500 x 420
03.920.420G	2000 x 420

Item no.	Dimensions in mm (W x D)
03.910.620G	1000 x 600
03.915.620G	1500 x 600
03.920.620G	2000 x 600

**Holder for label rolls**

Item no.	Width in mm
PT10ETHAMW	1000
PT15ETHAMW	1500

**Shelf depth 220 mm**

Item no.	Dimensions in mm (W x D x H)	Usable dimensions in mm (W x D)
03.910.220	1000 x 220 x 20	914 x 218
03.915.220	1500 x 220 x 20	1414 x 218
03.920.220	2000 x 220 x 20	1864 x 218

Shelf depth 320 mm

Item no.	Dimensions in mm (W x D x H)	Usable dimensions in mm (W x D)
03.910.320	1000 x 320 x 20	914 x 318
03.915.320	1500 x 320 x 20	1414 x 318
03.920.320	2000 x 320 x 20	1864 x 318

Shelf depth 420 mm

Item no.	Dimensions in mm (W x D x H)	Usable dimensions in mm (W x D)
03.910.420	1000 x 420 x 20	914 x 418
03.915.420	1500 x 420 x 20	1414 x 418
03.920.420	2000 x 420 x 20	1864 x 418

**Bracket for shelves depth 420 mm**

Item no.	Height in mm
03.PT2956	250
03.PT2957	450

Bracket for shelves depth 600 mm

Item no.	Height in mm
03.PT2954	250
03.PT2955	450

Scanner holder

- Maximum freedom of adjustment
- Suitable for standard industrial scanners
- Opening: 90 x 54 mm
- Max. scanner size (WxHxD): 89 x 55 x 125 mm
- Slats: 18 pieces, 15 mm width
- Housing: Solid plastic housing, steel bracket
- Delivery without scanner



Item no.
PTSCHA100548



Packing tables - workplace systems

Accessories

New

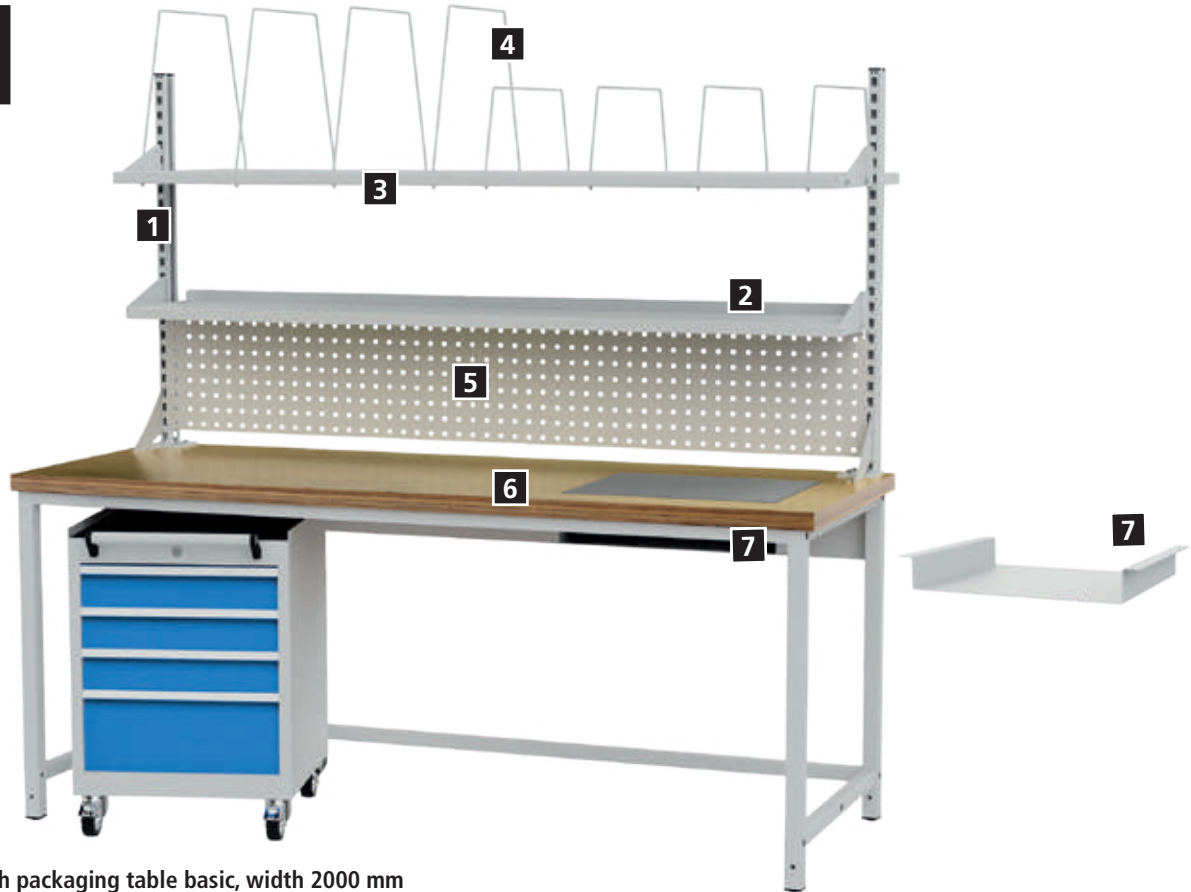

Combination with packing table basic, width 2000 mm

POS	Item no.	Dimensions in mm (W x D x H)	Description
1	03.935.950.240	H 950	Support column 30 x 60 mm, left
	03.935.950.140	H 950	Support column 30 x 60 mm, right
2	03.920.320	2000 x 320 x 20	Shelf, depth 320 mm
3	03.920.620G	2000 x 600	Shelf, perforated, for mounting between support columns
4	03.PT2956	H 250 mm	Bracket for shelf depth für 420mm
	03.PT2957	H 450 mm	Bracket for shelf depth für 420mm
5	03.983.105	2000 x 20 x 302	Perforated wall
6	03.PTWAAUSS	2000 x 750 x 40	Worktop with cut-out for table scale, please state the base area of the scale
7	03.PTWAHA		Table scale holder U-shaped for mounting under the worktop Please state the base area and height of the scale.

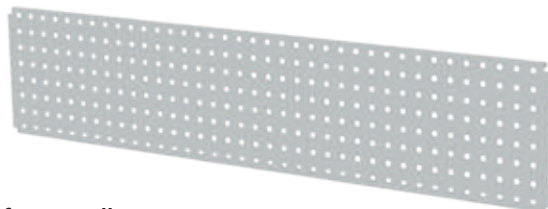

Perforate wall

- 2000 mm perforated walls can only be attached to setups without an overhead frame, otherwise 2 x 1000 mm are required
- Steel plate, square perforation 10 x 10 mm

Item no.	Dimensions in mm (W x D x H)
03.983.101	700 x 20 x 302
03.983.103	1500 x 20 x 302
03.983.105	2000 x 20 x 302

New



Tablet wall mount with pivot arm

- Universally and flexibly applicable
- Optimum viewing distance thanks to individual table screen positioning
- Inclination: -6° to +46°; rotatable: 180°
- Colour: silver metallic

Item no.	Dimensions in mm (W x D x H)	Mounting
07.8934LW	95 x 225 x 170	Perforated wall
07.8934TR		Support column

New



Accessory set for swivelling workplace lights

- 2 pieces

Item no.	Height in mm	Suitable for
4016221000	80	LED lamp premium (page 319-322)
4016137000	80	LED lamp universal (page 318)



Energy duct with 2x earthed socket and 1x network port

- For mounting under the worktop or on the support column

Item no.	Dimensions in mm (W x D x H)
PTEK375	375 x 60 x 130



Standard pivot arm bracket | Support column

- For lateral mounting at support column
- For holding the pivot arm

Item no.	Version
07.98.02	For 40 x 40 x 2 mm pivot arm



Pivot arm with shelf and ribbed rubber mat

Item no.	Dimensions in mm (W x D x H)
07.98.11	420 x 300 x 20



Pivot arm with monitor bracket

- VESA 75 / 100 mm

Item no.	Dimensions in mm (W x D x H)
07.98.07	700 x 370 x 320



Pivot arm with monitor bracket and keyboard platform

- VESA 75 / 100 mm
- Tray made of steel sheet

Item no.	Dimensions in mm (W x D x H)
07.98.15	700 x 370 x 320



Flat screen holder for perforated wall

- VESA Standard

Item no.	Dimensions in mm (W x D x H)
07.45.21	160 x 30 x 210



Swiveling monitor bracket, for attachment to the flat screen holder

- VESA Standard

Item no.	Dimensions in mm (W x D x H)
07.45.22	125 x 75 x 125



Packing tables - workplace systems

Packing tables - Real world combinations

New



Axle kit

- Incl. additional strut and axle tube Ø 32 mm
- Can be retrofitted
- Can be used for packing table basic and comfort

Item no.	Width in mm
03.PTACS15	1500
03.PTACS20	2000

Hanging cabinet

- Drawers with full pull-out 100 % - load capacity 50 kg
- Drawer guides on ball bearing



- 1 x drawer 150 mm

Item no.	Dimensions in mm (W x D x H)
53.150	531 x 500 x 215
38.150	381 x 500 x 215



- 3 x drawer 100 mm

Item no.	Dimensions in mm (W x D x H)
53.300	531 x 500 x 365
38.300	381 x 500 x 365



- 2 x drawer 200 mm

Item no.	Dimensions in mm (W x D x H)
44.011	531 x 500 x 465
38.011	381 x 500 x 465



- 1 x hinged door 350 mm

Item no.	Dimensions in mm (W x D x H)
44.001	531 x 500 x 465



Support for hanging cabinets basic

- Mandatory for installation of hanging cabinets
- Beech multiplex
- Packing unit: 2 pieces

Item no.
03.5340.35



Support for hanging cabinets comofort

- Mandatory for installation of hanging cabinets
- Packing unit: 2 pieces

Item no.	Suitable for table depth in mm
4XXXXX75TR	750
4XXXXX90TR	900

New

- Construction made of 45 x 45 mm square tube
- Feet made of aluminium profile 40 x 40 mm
- Worktop optionally:
Beech multiplex, glue laminated, oiled or



Side tabel height adjustable

- Worktop beech multiplex, 40 mm

Item no.	Dimensions in mm (W x D x H)
4075KL75GB	750 x 750 x 710-1055
4075KL90GB	750 x 900 x 710-1055

- MDF worktop with 0.7 mm HPL coat, 4-sided ABS edging
- Clamp fixing, load capacity 200 kg
- Delivery unassembled



Side table height adjustable

- Worktop MDF with HPL coat, 40 mm

Item no.	Dimensions in mm (W x D x H)
4075KL75GH	750 x 750 x 710-1055
4075KL90GH	750 x 900 x 710-1055



workergo 4-foot- eypander casters Ø 100 mm

Item no.	Description
4XXXXXMBL100	2 x fixed caster, 2 x steering caster without lock
4XXXXXMLL100	4 steering caster, thereof 2 with locks

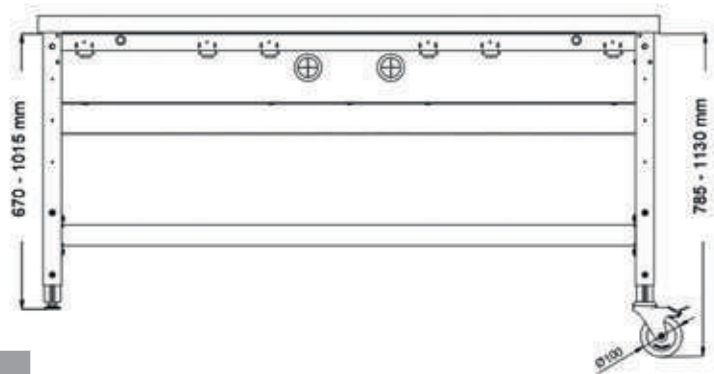

Roll container

- 3 x drawer
- Usable drawer dimensions: 450 x 400 mm
- Central locking
- Drawers with full pull-out 100 %, load capacity each 50 kg
- Incl. roll-off edge
- 4 x steering caster Ø 80 mm, thereof mit 2 x mit Feststeller with lock

Item no.	Dimensions in mm (W x D x H)
46.021BR80	530 x 500 x 745



Roll container

- 4 x drawer
- Usable drawer dimensions: 450 x 400 mm
- Central locking
- Drawers with full pull-out 100 %, load capacity each 50 kg
- Incl. roll-off edge
- 4 x steering caster Ø 80 mm, thereof mit 2 x mit Feststeller with lock

Item no.	Dimensions in mm (W x D x H)
46.220BR80	530 x 500 x 745



Packing tables - workplace systems

Cutting stands

- Cutting stand for cardboard, bubble wrap, foam film, etc.
- Easily exchangeable blade cartridge
- Circular blade for paper, corrugated cardboard, etc.
- Blade knife for foils, soft films and bubble wrap



Unwind stand, mobile

- Max. weight per roll 200 kg
- Max. roll dia. 500 mm

Item no.	Cutting width x D x H in mm
07.23107	750 / 1000 x 600 x 400
07.23110	1000 / 1250 x 600 x 400
07.23112	1250 / 1500 x 600 x 400



Horizontal cutting stand, double

- Outlet height continuously adjustable
- Max. roll dia. 800 mm each
- Max. total weight 130 kg

Item no.	Cutting width x D x H in mm
07.26407	1120 x 850 x 1665
07.26410	1370 x 850 x 1665
07.26412	1620 x 850 x 1665
07.26416	1920 x 850 x 1665



Attachment cutting device

- Clamping range up to 70 mm

Item no.	Cutting width x D x H in mm
07.55107	750 / 1033 x 250 x 280
07.55110	1000 / 1283 x 250 x 280
07.55112	1250 / 1533 x 250 x 280



Horizontal cutting stand

- Outlet height continuously adjustable
- Max. roll dia. 800 mm
- Max. 100 kg

Item no.	Cutting width x D x H in mm
07.26207N	750 / 1120 x 850 x 1165
07.26210N	1000 / 1370 x 850 x 1165
07.26212N	1250 / 1620 x 850 x 1165
07.26216N	1600 / 1970 x 850 x 1165
07.26218N	1800 / 2170 x 850 x 1165



Table cutting device

- Max. roll dia. 250 mm
- Max. 80 kg

Item no.	Cutting width x D x H in mm
07.25607	750 / 1000 x 341 x 340
07.25610	1000 / 1250 x 341 x 340
07.25612	1250 / 1500 x 341 x 340
07.25716	1600 / 1850 x 341 x 340



Vertical cutting stand

- Max. roll dia. 800 mm
- Max. 200 kg

Item no.	Cutting width x D x H in mm
07.35110	1000 / 800 x 880 x 1295
07.35112	1250 / 800 x 880 x 1545
07.35116	1600 / 800 x 880 x 1895
07.35118	1800 / 800 x 880 x 2095
07.35120	2000 / 800 x 880 x 2295

New

WEIGHING
UP TO 60 KG**Table scales, dual range**

- Stainless steel weighing platform
- Substructure powder-coated. Reliable, extremely precise industrial
- Incl. evaluation unit 82B1, calibratable class III
- Can be used as table and wall unit
- Membrane keypad with 6x short-stroke key
- 1x strain gauge weighbridge can be connected
- 1x serial RS-232 onboard interface
- Integrated 230 V power supply
- Mains plug with 2 m cable
- Strain gauge weighing cell made of anodised aluminium alloy (IP66)
- 2 m measuring cable (fixed connection)
- EC-calibratable Class III
- Weighing range up to 60 kg/20 g



Item no.	Weighing platform in mm	Weighing range in kg	Increment in g
03.WA833B1	500 x 400	60	20

Conformity assessment (HKB) for scales up to 60 kg

Item no.
03.WA114223

Counting scales 30kg/1g, non-calibratable

- ABS plastic housing
- Stainless steel weighing platform
- 3x LCD display, digit height 14 mm with blue backlight, membrane keyboard with tactile keys, numeric keypad and acoustic feedback
- Weighing functions: taring, counting, totalising, target weight checking
- Serial RS-232 interface, Sub-D socket for printer connection, acoustic-optical signal
- Optimisation of counting accuracy
- Memory for 200 reference weights
- Battery operation
- Plug-in power supply with 1.5 m cable
- Incl. transparent protective hood
- For counting parts from 0.8 g



Item no.	Weighing platform in mm	Weighing range in kg	Increment in g
03.WA200927	280 x 220	30	1



work alu[®]



General perks and advantages of aluminium profiles*

- Modular, simple plug-in system for all requirements
- No drilling. The profiles are already cut to size and provided for easy self-assembly
- Non-magnetic or magnetisable
- The surface of the aluminium profile is anodised and therefore not electrically conductive. It serves as electrical insulation
- When correctly contacted, the aluminium profile has good electrical conductivity. Contact is made via the front of the profile, which has no anodised layer
- Very light due to its low density of 2.71 g/cm³, which is about one about one third of the weight of steel
- Highly corrosion resistant
- Hygienic, easy to clean

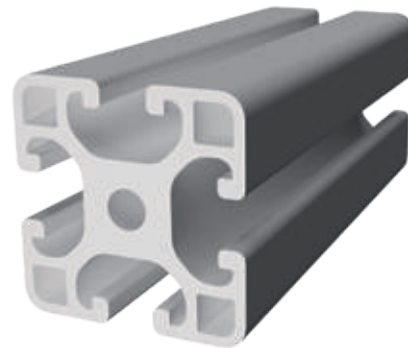

Characteristics and advantages of the workalu[®] product series

- High combination variety due to the modular system
- Quick and easy combination of all tables and accessories
- Quick and easy profile shifting through corner connections, double-sided frames and add-on modules
- Extensive range of accessories, current accessories can be combined with the new workalu[®] series
- Position of the profiles variable and steplessly adjustable

How it works:

1 The sleeves with the screws are screwed into the profile grooves with a drill. The slot nuts are pushed into the groove of the profile to which the first profile is to be screwed. **2** Then the screws are screwed into the slot nuts and tightened.

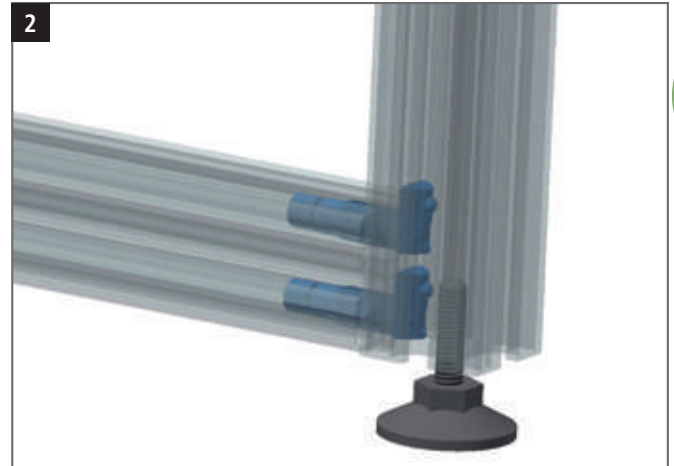
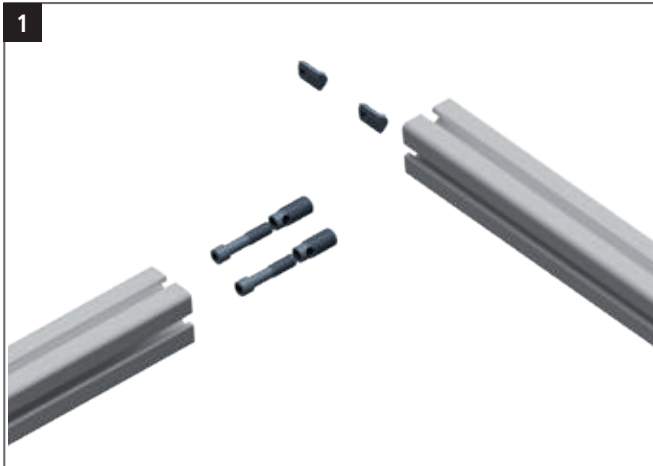

Levelling:

The height of the workalu® 4-leg tables can be adjusted by 20 mm. Floor unevenness can thus be easily compensated for.



Our solution

The workalu® has the ability to grow with the diversity of your workplace. Thanks to the flexibility of the aluminium profile and the numerous accessories, the workstation can be extended at any time. This allows for a perfectly optimized handling area, which is essential from an ergonomic point of view.

Advantages:

- Assembly times are reduced
- Ergonomic workplace design
- Modular and easily expandable
- Slim and timeless design

With workalu® workplaces adapt to the requirements of the user and not vice versa. It can be variably expanded and changed at any time. Only this variability and flexibility allows for highly optimised workflows. Static, unchangeable workplaces are a thing of the past.





Worktops



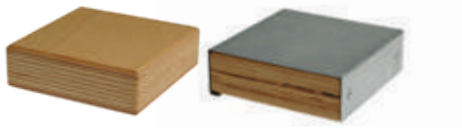

Beech multiplex worktop | with steel edges

Page 424



Solid red beech worktop

Page 426



Workbench top end profiles and rear edge profile

Page 427



MDF worktops, plastic worktops

Page 428



Worktop connector

Page 430



Chipboard worktop and ESD conductive worktop

Page 431



Worktops

Beech multiplex worktop | with steel edges



Beech multiplex worktop

- Glue laminated, oiled
- Water repellent
- Gluing according to EN 314-2

Top thickness (mm)	25		40		50	
Dimensions in mm (WxD)	Item no.	Item no.	Item no.	Item no.	Item no.	Item no.
750 x 600	03.7560.25	03.7560.40	03.7560.50			
1000 x 600	03.1060.25	03.1060.40	03.1060.50			
1250 x 600	03.1260.25	03.1260.40	03.1260.50			
1500 x 600	03.1560.25	03.1560.40	03.1560.50			
1750 x 600	03.1760.25	03.1760.40	03.1760.50			
2000 x 600	03.2060.25	03.2060.40	03.2060.50			
2500 x 600	03.2560.25	03.2560.40	03.2560.50			
750 x 750	03.7575.25	03.7575.40	03.7575.50			
810 x 750	03.81.25	03.81.40	03.81.50			
1000 x 750	03.10.25	03.10.40	03.10.50			
1250 x 750	03.125.25	03.125.40	03.125.50			
1500 x 750	03.15.25	03.15.40	03.15.50			
1750 x 750	03.1775.25	03.1775.40	03.1775.50			
2000 x 750	03.20.25	03.20.40	03.20.50			
2500 x 750	03.25.25	03.25.40	03.25.50			
750 x 900	03.7590.25	03.7590.40	03.7590.50			
1000 x 900	03.1090.25	03.1090.40	03.1090.50			
1250 x 900	03.1290.25	03.1290.40	03.1290.50			
1500 x 900	03.1590.25	03.1590.40	03.1590.50			
1750 x 900	03.1790.25	03.1790.40	03.1790.50			
2000 x 900	03.2090.25	03.2090.40	03.2090.50			
2500 x 900	03.2590.25	03.2590.40	03.2590.50			



Beech multiplex worktop with cover

For automotive workshops, paint shops and welding work

- With 1.5 mm thick galvanised steel cover, bolted on as an L-profile

Top thickness (mm)	40	50
Dimensions in mm (WxD)	Item no.	Item no.
810 x 750	A03.81.40	A03.81.50
1000 x 750	A03.10.40	A03.10.50
1250 x 750	A03.125.40	A03.125.50
1500 x 750	A03.15.40	A03.15.50
2000 x 750	A03.20.40	A03.20.50
2500 x 750	A03.25.40	A03.25.50
1000 x 900	A03.1090.40	A03.1090.50
1250 x 900	A03.12590.40	A03.12590.50
1500 x 900	A03.1590.40	A03.1590.50
2000 x 900	A03.2090.40	A03.2090.50
2500 x 900	A03.2590.40	A03.2590.50



Beech multiplex worktop with cover

For automotive workshops, paint shops and welding work

- With recessed 1.5 mm stainless steel cover, bolted on as an L-profile

Top thickness (mm)	40	50
Dimensions in mm (WxD)	Item no.	Item no.
810 x 750	AE038140	AE038150
1000 x 750	AE031040	AE031050
1250 x 750	AE0312540	AE0312550
1500 x 750	AE031540	AE031550
2000 x 750	AE032040	AE032050
2500 x 750	AE032540	AE032550
1000 x 900	AE03109040	AE03109050
1250 x 900	AE031259040	AE031259050
1500 x 900	AE03159040	AE03159050
2000 x 900	AE03209040	AE03209050
2500 x 900	AE03259040	AE03259050

Worktops

Red beech, solid



Solid red beech worktop

- Strip laminated
- Finger jointed
- Glued wood panel with distinctive grain

Top thickness (mm)	40	50
Dimensions in mm (WxD)	Item no.	Item no.
1000 x 600	03.1060.40RB	03.1060.50RB
1250 x 600	03.1260.40RB	03.1260.50RB
1500 x 600	03.1560.40RB	03.1560.50RB
2000 x 600	03.2060.40RB	03.2060.50RB
2500 x 600	03.2560.40RB	03.2560.50RB
810 x 750	03.81.40RB	03.81.50RB
1000 x 750	03.10.40RB	03.10.50RB
1250 x 750	03.125.40RB	03.125.50RB
1500 x 750	03.15.40RB	03.15.50RB
2000 x 750	03.20.40RB	03.20.50RB
2500 x 750	03.25.40RB	03.25.50RB
1000 x 900	03.1090.40RB	03.1090.50RB
1250 x 900	03.1290.40RB	03.1290.50RB
1500 x 900	03.1590.40RB	03.1590.50RB
2000 x 900	03.2090.40RB	03.2090.50RB
2500 x 900	03.2590.40RB	03.2590.50RB



Beech multiplex worktop with steel edge

- With recessed 3 mm steel edge, bolted on as an L-profile

Top thickness (mm)	40	50
Dimensions in mm (WxD)	Item no.	Item no.
1000 x 600	K03.1060.40	K03.1060.50
1250 x 600	K03.12560.40	K03.12560.50
1500 x 600	K03.1560.40	K03.1560.50
2000 x 600	K03.2060.40	K03.2060.50
2500 x 600	K03.2560.40	K03.2560.50
810 x 750	K03.81.40	K03.81.50
1000 x 750	K03.10.40	K03.10.50
1250 x 750	K03.125.40	K03.125.50
1500 x 750	K03.15.40	K03.15.50
2000 x 750	K03.20.40	K03.20.50
2500 x 750	K03.25.40	K03.25.50
1000 x 900	K03.1090.40	K03.1090.50
1250 x 900	K03.12590.40	K03.12590.50
1500 x 900	K03.1590.40	K03.1590.50
2000 x 900	K03.2090.40	K03.2090.50
2500 x 900	K03.2590.40	K03.2590.50



Workbench top end profiles, 3-sided

- Beech multiplex
- Height 120 mm
- Thickness 15 mm

Item no.	Dimensions in mm (WxD)
PA.7560.12	750 x 600
PA.1060.12	1000 x 600
PA.1260.12	1250 x 600
PA.1560.12	1500 x 600
PA.1760.12	1750 x 600
PA.2060.12	2000 x 600
PA.2560.12	2500 x 600
PA.7575.12	750 x 750
PA81	810 x 750
PA.1075.12	1000 x 750
PA.1275.12	1250 x 750
PA150	1500 x 750
PA.1775.12	1750 x 750
PA200	2000 x 750
PA250	2500 x 750
PA.7590.12	750 x 900
PA.1090.12	1000 x 900
PA.1290.12	1250 x 900
PA.1590.12	1500 x 900
PA.1790.12	1750 x 900
PA.2090.12	2000 x 900
PA.2590.12	2500 x 900

Rear edge profile

- Beech multiplex
- Height 120 mm
- Thickness 15 mm

Item no.	Dimensions in mm (width)
RPA75	750
RPA81	810
RPA100	1000
RPA125	1250
RPA150	1500
RPA175	1750
RPA200	2000
RPA250	2500

Worktops

MDF worktops, plastic worktops

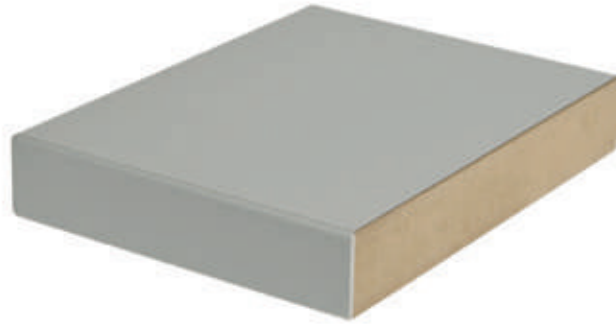

MDF worktop with 0.7 mm HPL coat | For assembly, shipping and laboratory

- HPL (high pressure laminate), also called "Resopal" is fire retarding as well as shock-, scratch- and abrasion-resistant
- 4-sided, ABS edging
- Heat and light resistant
- Stain-resistant, easy to clean and to disinfect
- Solvent resistant and largely chemical resistant

Top thickness (mm)	30	40	50
Dimensions in mm (WxD)	Item no.	Item no.	Item no.
750 x 600	H03.7560.30	H03.7560.40	H03.7560.50
1000 x 600	H03.1060.30	H03.1060.40	H03.1060.50
1250 x 600	H03.1260.30	H03.1260.40	H03.1260.50
1500 x 600	H03.1560.30	H03.1560.40	H03.1560.50
1750 x 600	H03.1760.30	H03.1760.40	H03.1760.50
2000 x 600	H03.2060.30	H03.2060.40	H03.2060.50
2500 x 600	H03.2560.30	H03.2560.40	H03.2560.50
750 x 750	H03.7575.30	H03.7575.40	H03.7575.50
810 x 750	H03.81.30	H03.81.40	H03.81.50
1000 x 750	H03.1075.30	H03.1075.40	H03.1075.50
1250 x 750	H03.1275.30	H03.125.40	H03.125.50
1500 x 750	H03.15.30	H03.15.40	H03.15.50
1750 x 750	H03.1775.30	H03.1775.40	H03.1775.50
2000 x 750	H03.20.30	H03.20.40	H03.20.50
2500 x 750	H03.25.30	H03.25.40	H03.25.50
750 x 900	H03.7590.30	H03.7590.40	H03.7590.50
1000 x 900	H03.1090.30	H03.1090.40	H03.1090.50
1250 x 900	H03.1290.30	H03.1290.40	H03.1290.50
1500 x 900	H03.1590.30	H03.1590.40	H03.1590.50
1750 x 900	H03.1790.30	H03.1790.40	H03.1790.50
2000 x 900	H03.2090.30	H03.2090.40	H03.2090.50
2500 x 900	H03.2590.30	H03.2590.40	H03.2590.50

MDF worktop with 2.5 mm Trovidur coat

- With robust, hard-wearing 2.5 mm plastic coat
- 4-sided ABS edging
- Low flammability surface
- Very good electrical insulating properties
- High resistance to acids, lyes and salt solutions
- Areas of application: Chemical tank and plant construction, electrical industry, construction industry

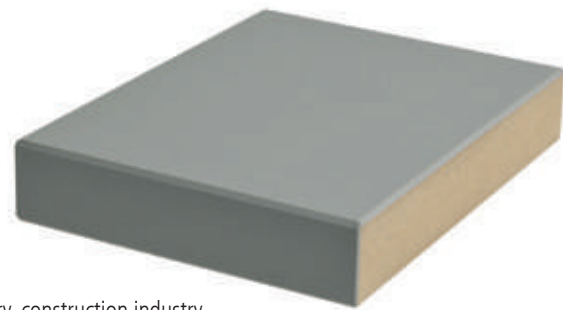

Top thickness (mm)	30	40	50
Dimensions in mm (WxD)	Item no.	Item no.	Item no.
1000 x 600	T03.1060.30	T03.1060.40	T03.1060.50
1250 x 600	T03.1260.30	T03.1260.40	T03.1260.50
1500 x 600	T03.1560.30	T03.1560.40	T03.1560.50
2000 x 600	T03.2060.30	T03.2060.40	T03.2060.50
810 x 750	T03.81.30	T03.81.40	T03.81.50
1000 x 750	T03.10.30	T03.10.40	T03.10.50
1250 x 750	T03.125.30	T03.125.40	T03.125.50
1500 x 750	T03.15.30	T03.15.40	T03.15.50
2000 x 750	T03.20.30	T03.20.40	T03.20.50
1000 x 900	T03.1090.30	T03.1090.40	T03.1090.50
1250 x 900	T03.1290.30	T03.1290.40	T03.1290.50
1500 x 900	T03.1590.30	T03.1590.40	T03.1590.50
2000 x 900	T03.2090.30	T03.2090.40	T03.2090.50

Plastic worktop

- Plastic worktop, pressed polyethylene PE 500
- Surface white
- Highly resistant to wear and abrasion
- Excellent chemical resistance
- Highly impact, cut and scratch-proof
- Low flammability
- Area of application: Assembly and automation technology
- Printing and textile industry, conveyor and storage technology



Top thickness (mm)	20	25	30
Dimensions in mm (WxD)	Item no.	Item no.	Item no.
1500 x 750	KUW03.15.20	KUW03.15.25	KUW03.15.30
2000 x 750	KUW03.20.20	KUW03.20.25	KUW03.20.30

Plastic worktop

- Worktop made from pressed reclaimed material
- Surface multicoloured/black
- Resistant to lyes and acids
- Area of application: Electroplating, bulk goods industry, food industry, paper industry



Top thickness (mm)	20	25	30
Dimensions in mm (WxD)	Item no.	Item no.	Item no.
1500 x 750	KUS03.15.20	KUS03.15.25	KUS03.15.30
2000 x 750	KUS03.20.20	KUS03.20.25	KUS03.20.30

Worktops

MDF worktop and top connector

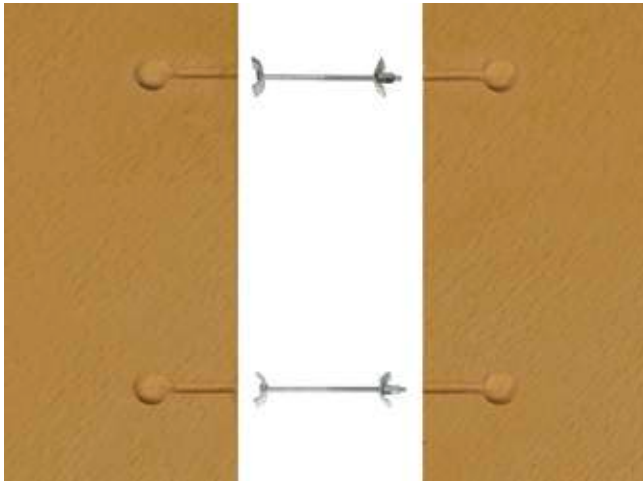

Top-top connector

- With Lamello and two fixing clamps

Item no.
03.00.32

MDF worktop with 2.5 mm linoleum coat

- 4-sided ABS edging
- Easy to care
- Durable
- Antistatic
- Scratch resistant
- Due to the production process, a yellow patina may be visible at the beginning, which disappears again with time due to the influence of light
- Production, light and environmental influences may lead to colour differences and colour changes in the coating
- Made from purely natural raw materials, thus linoleum is very environmentally friendly in production, use and disposal
- Areas of application: technical, electrical and chemical works



Top thickness (mm)	30	40	50
Dimensions in mm (WxD)	Item no.	Item no.	Item no.
1000 x 600	L03.1060.30	L03.1060.40	L03.1060.50
1250 x 600	L03.1260.30	L03.1260.40	L03.1260.50
1500 x 600	L03.1560.30	L03.1560.40	L03.1560.50
2000 x 600	L03.2060.30	L03.2060.40	L03.2060.50
2500 x 600	L03.2560.30	L03.2560.40	L03.2560.50
810 x 750	L03.81.30	L03.81.40	L03.81.50
1000 x 750	L03.10.30	L03.10.40	L03.10.50
1250 x 750	L03.125.30	L03.125.40	L03.125.50
1500 x 750	L03.15.30	L03.15.40	L03.15.50
2000 x 750	L03.20.30	L03.20.40	L03.20.50
2500 x 750	L03.25.30	L03.25.40	L03.25.50
1000 x 900	L03.1090.30	L03.1090.40	L03.1090.50
1250 x 900	L03.1290.30	L03.1290.40	L03.1290.50
1500 x 900	L03.1590.30	L03.1590.40	L03.1590.50
2000 x 900	L03.2090.30	L03.2090.40	L03.2090.50
2500 x 900	L03.2590.30	L03.2590.40	L03.2590.50



Chipboard worktop with melamine resin coating

- 4-sided, ABS edging
- Chipboard carrier plate with direct coating
- Abrasion-resistant and easy to care for surface

ESD conductive worktop

- Surface made from conductive HPL laminate
- Suitable for all electrostatically sensitive areas
- Surface RAL 7035



Top thickness (mm)	28
Dimensions in mm (WxD)	Item no.
750 x 600	07.M7560.28
1000 x 600	07.M1060.28
1250 x 600	07.M12560.28
1500 x 600	07.M1560.28
1750 x 600	07.M1760.28
2000 x 600	07.M2060.28
750 x 750	07.M7575.28
810 x 750	07.M8175.28
1000 x 750	07.M1075.28
1250 x 750	07.M12575.28
1500 x 750	07.M1575.28
1750 x 750	07.M1775.28
2000 x 750	07.M2075.28
2500 x 750	07.M2575.28
750 x 900	07.M7590.28
1000 x 900	07.M1090.28
1250 x 900	07.M12590.28
1500 x 900	07.M1590.28
1750 x 600	07.M1790.28
2000 x 900	07.M2090.28

Top thickness (mm)	30
Dimensions in mm (WxD)	Item no.
750 x 600	07.E7560.30
1000 x 600	07.E1060.30
1250 x 600	07.E12560.30
1500 x 600	07.E1560.30
1750 x 600	07.E1760.30
2000 x 600	07.E2060.30
750 x 750	07.E7575.30
810 x 750	07.E8175.30
1000 x 750	07.E1075.30
1250 x 750	07.E12575.30
1500 x 750	07.E1575.30
1750 x 750	07.E1775.30
2000 x 750	07.E2075.30
2500 x 750	07.E2575.30
750 x 900	07.E7590.30
1000 x 900	07.E1090.30
1250 x 900	07.E12590.30
1500 x 900	07.E1590.30
1750 x 900	07.E1790.30
2000 x 900	07.E2090.30



ESD ElectroStaticDischarge





Overview

Page 434



Measuring and test devices

Page 438



ESD-workergo

Page 440



ESD-workraster

Page 443



ESD-workline

Page 444



EDS accessories

Page 445



ESD parts trolley

Page 452



ESD chairs

Page 453



ESD stands for electrostatic discharge. A large potential difference causes a spark or disruptive discharge, which produces high electric voltage pulses in electronic devices.

Humans first feel an electrostatic charge from 3000 volts, and in most cases the discharge is harmless, with the moment of shock being the worst part.

When is ESD dangerous?

Sparking can already occur at 10000 volts and can cause explosions if flammable liquids or gases are being handled. Static electricity is produced, for example, when running on a carpeted floor, whereby a person can become charged to approx. 30000 volts in some cases.

The effects of ESD are insidious, meaning that the damage is not immediately visible, and the causer often does not notice it. The consequences can become costly, especially if the assembly is installed in devices for sensitive applications. Sensitive components can be destroyed from just 40 volts.

EPA offers protection against ESD!

EPA = Electrostatic Protected Area

A work area equipped with ESD protective measures where electrostatically sensitive components can be handled without damaging them.

A comprehensive EPA protection area includes the following areas:

- Workstation
- Personal grounding
- Tools
- Markings
- Measurement technology
- Storage/containers
- Flooring

The ESD standard DIN EN 61340-5-1 applies to electronics production facilities.

All products listed here comply with this standard.



Four golden rules for dealing with ESD

1. Always presume that all active components are ESD-sensitive.
2. Only touch electronic components in ESD protection areas (EPA) and then only when you are properly grounded.
3. Store and transport ESD-sensitive components in ESD protective containers.
4. Regularly check the ESD protection system.

Observe the principle *“No charge, no discharge”*.

Making as few movements as possible and using ESD-safe equipment reduces the risk of a static charge on people to a minimum.

ESD GLOSSARY

A

Bleeder resistance:

Measurement between an earthing point and the electrodes on a surface.

Antistatic:

The "electrostatic charge reduction property", could be a special type of plastic, for example.

Workstation

The ESD-protected workstation should be ergonomically adaptable. Electrostatic charge is dissipated via the worktop and a earthing cable so that the workstation remains charge-neutral.

D

Dissipative:

Surface resistance of materials between 10^5 and 10^{12} Ω .

E

EPA:

Electrostatic protected area, a work area where electrostatically sensitive components can be handled without damaging them.

Earthing:

Discharge of electric currents into the ground.

Earthing point:

Central point (e.g. on a worktop) that is connected to the building's earthing.

ESD:

The phenomenon of electrostatic discharge.

ESDS:

Electrostatic discharge sensitive devices.

F

Flooring

The flooring should be conductive and comply with the required limit values specified in DIN EN 61340-5-1. When cleaning ESD flooring, use only cleaning agents that do not form layers so that the conductivity values remain within the desired range. If only individual workstations are set up as EPAs, ESP floor mats or tiles can also be earthed.

I

IC:

Integrated circuit, microchip, e.g. microprocessor.

Ionisation:

Removal of charged particles (e.g. electrons) from a material such as air. Ionisation devices can neutralise electrostatic charges by distributing ionised air.

Isolator:

Materials that have a high surface resistance of at least 10^{12} Ω . Static charges remain in a part of these materials for a long time without discharging (plastic, glass, air).

L

Storage/containers

Conductive ESD shelving and containers for transporting and storing components protect endangered components. Assembly trolleys should be fitted with conductive wheels.

Conductivity:

Ability of a material to conduct electrical current, e.g. metals.

M

Markings

Markings on the flooring indicate ESD protection areas. Signs and labels indicating potentially endangered components and assemblies are also important.

Measurement technology

Protective device must be metrologically tested regularly. When entering an EPA, measurements and regular personal inspections must be performed. Work benches, floor mats and earthing connections should be checked monthly and ESD monitoring instruments should be checked annually.

The respective bleeder resistances should have the following values: Worktop: between 7.5×10^5 Ω and 10^9 Ω , Flooring: less than 10^9 Ω , Chair/standing aid: less than 10^{10} Ω , Tool: less than 10^{12} Ω .

N

Standards:

IEC 61340-5-1 Protection of electronic devices from electrostatic phenomena - General requirements

IEC 61340-5-2 Protection of electronic devices from electrostatic phenomena - User guide

IEC 61340-4-1 Electrical resistance of floor coverings and installed floors

ANSI/ESD S20.20.-1999 Protection of Electrical and Electronic Parts, Assemblies and Equipment

ANSI/ESD S541-2003 Packaging materials for ESD sensitive items

O

Surface resistance:

Resistance between two points on a surface, measured using a megohmmeter and two electrodes.

P

Personal grounding

People are the main source of electrostatic charges. Shoes and a wrist strap with an earthing cable should be mandatory for employees in electronics production. Wrist strap and shoe testers facilitate the daily inspection of EPA effectiveness. The chair or standing aid should also have ESD protection.

S

Current:

Unit [A] ampere, formula symbol: I, flow of (mostly negative) charge carriers.

Voltage:

Unit [V] volt, formula symbol: U, maintains the electrical current in a closed circuit and is thus the cause for the flow of current.

W

Resistance:

Unit [Ω] Ohm, formula symbol: R, indicates what voltage is required to cause a particular current to flow through an electrical conductor.



To be able to ensure the reliability and quality of current electronic products, it is necessary to observe the most important **HANDLING REGULATIONS** when processing electrostatic discharge sensitive devices (ESDS):

1. ESDS may only be processed at electrostatic protection workstations (EPA)!
2. Ensure a constant "smooth" potential equalisation!
3. Ensure personal grounding via wrist and shoe earthing!
4. Ensure conductive, closed clothing!
5. Avoid electrostatic chargeable materials such as normal PE, PVC, polystyrene , etc.!
6. ESDS must not be exposed to electrostatic fields $> 100 \text{ V/cm}$!
7. Only use labelled and defined packaging and transport materials!
8. Employee training!

Standard colours

All ESD products on pages 440-444 have an eco-friendly, conductive powder coating.

Here you can see our 7 standard colours, which may deviate slightly from the standard RAL colours due to the pigmentation.



RAL 3003
Ruby red



RAL 5010
Gentian blue



RAL 5012 Light
blue

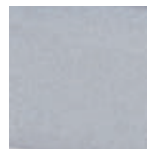

RAL 7035
Light grey



RAL 7038
Agate grey



RAL 9005
Jet black

ESD guidelines at a glance: DIN EN 61340-5-1

Last updated in July 2017, DIN EN 61340-5-1 is the standard dealing with electrostatic charge in connection with technical devices. Official title of this ESD standard: "Protection of electronic devices from electrostatic phenomena". As part of the international series of standards 61340, which deals with electrostatics in all areas, it is of significance for many industrial companies. Essentially, DIN EN 61340-5-1 contains the requirements that companies must place on their design, concept, creation, setup and maintenance processes for the effective management of electrostatic charges.

The requirements formulated are directly related to electrical parts, components or devices that are manufactured, further processed, packaged, operated or handled in any other way and that can be damaged by electrostatic charges. Adherence to ESD guidelines for companies with sensitive production areas such as clean rooms is of particular importance. Sources of electrostatic charge are also considered in DIN EN 61340-5-1. For example, certain material combinations, gases, impurities or the employees themselves unknowingly produce such charges.

Standard-compliant industrial chairs ensure product safety

In clean rooms compliance with such ESD guidelines should always have top priority. It therefore not only makes sense to orient clean room chairs and industrial chairs to this requirement, but also to prevent the occurrence of electrostatic charges to the greatest extent possible by means of suitable further measures. Companies from the electrical industry should already have a great operational interest in implementing such standards, e.g. DIN EN 61340-5-1, as precisely as possible and striving for their optimal integration into operational workflows.

- Tests personal bleeder resistances for wrist strap and footwear grounding systems to monitor access to electrostatic protection areas (EPAs)
- The test result is signalled visually and audibly. An additional potential-free relay contact makes it possible to control a door opener or turnstile, for example, to control access
- Voltage is supplied by an integrated battery or a plug-in power supply
- Tests wrist strap grounding
- Simultaneous testing of right and left shoe possible thanks to separate measuring circuits

- In combination with entry control systems (e.g. turnstiles), footwear measurements can be performed in hands-free mode without pressing the button
- Test voltage 30, 50 or 100 volts (standard setting)
- The lower limit values can be deactivated
- Can be used as a table-top or wall-mounted device (as a wall-mounted device, the optional wall bracket is required)
- Limit values can be adjusted using a DIP switch



Personnel Grounding PGT®120

- Scope of delivery: Footwear testing electrode, works calibration certificate, instructions for use (German/English), 9 V battery, 230 V AC plug-in power supply

Item no.	Type
1 EPGT120	Personnel Grounding Tester PGT®120
EPGT120.WK	Wall bracket for PGT®120 and PGT®120.COM made of stainless steel (not illustrated)

Personnel Grounding accessories

Item no.	Type
2 EPGT120.CU.12	Calibration unit for PGT®120 and PGT®120.COM for on-site testing, incl. works calibration certificate for PGTs with 12 dip switches
3 EPGT120.12.S	Test station mat with yellow leading edge

PGTest Station

- Powder coating in the colours depicted
- Test station for the PGT®120
- Dimensions: 590 x 730 x 1700 mm (W x D x H)
- PGT®120 not included in the scope of delivery

Item no.	Type
EPGT120.TEST	PGTest Station for PGT®120 / PGT®120.COM with magnetic document holder made of IDP-STAT-PVC in A3

Measuring and test devices

METRISO® B530 measuring lit

Metriso® B530 – MEASURING KIT

- For measuring point-to-point and bleeder resistances in accordance with DIN EN 61340-4-1 and DIN EN 61340-2-3 (VDE 0300, Part 4-1 / 2-3)
- For measuring the system resistance of human/footwear/flooring systems in accordance with DIN EN 61340-4-5 (VDE 0300, Part 4-5)
- Additional low-ohmic measuring range of 1 Ω - 10 k Ω for testing earthing measures, digital and analogue measurement display, as bar graph or pointer
- Optical signalling of the voltage measuring range with red and green LED
- External voltage detection with red LED

- Measuring voltage:** DC 10 V, 100 V, 500 V
- Resistance measuring range:** 1 Ω to 199 G Ω
- Mode of operation:** Battery operation
- Electrodes:** 2x model 870: 1x hand electrode – model 45
1x extension set for electrode 870
- Dimensions:** 225 x 130 x 140 mm (WxDxH)
- Weight (complete KIT):** 9 kg



Electrode model 870



Extension set for electrode 870

Measuring and test instrument Metriso® B530

- 2x measuring electrode model 870 according to DIN EN 61340-4-1/2-3
- 1x hand electrode model 45 according to DIN EN 61340-4-5
- 1x extension set for electrode 870
- Conductive carry case

Item no.	Type
EB530.MK	Metriso® B530 complete measuring kit
ES530.G	Metriso® B530 measuring instrument with measuring cables

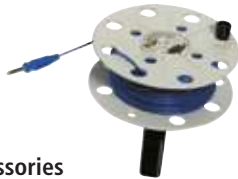

Optional accessories

Item no.	Type
E2000.TR50	Cable drum 50 m, with unwinder for ground measurements
E2000.ML	Spare measuring cable set (com/shield + positive cable)

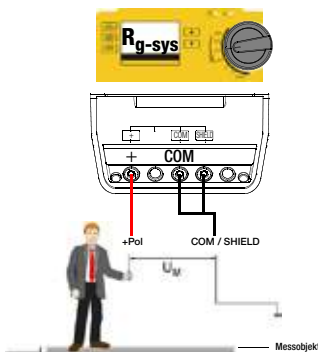

Measurement: $R_{G\text{-system}}$
Personal bleeder resistance (human/shows/flooring) to protective earth

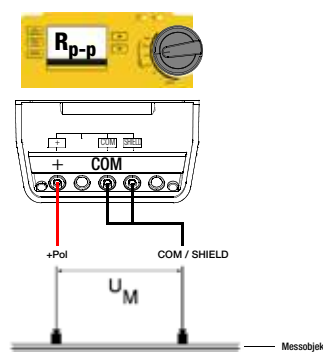

Measurement: R_{p-p}
Point-to-point resistance

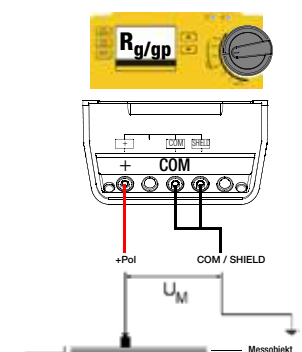

Measurement: R_G
Bleeder resistance to protective earth



Handheld meter for testing **conductive surfaces**. Test values displayed on LCD display. Delivery includes conductive carry case, earthing cable, USB cable, works calibration certificate and readout software for stored test data.

- **Measuring range:** $10^3 - 10^{12}$ ohm
- **Measuring voltage:** Open-circuit voltage 100 V
- **Mode of operation:** Battery operation
- **Display:** LCD display
- **Electrodes:** Bar electrode with conductive rubber

- With data storage and USB interface to PC
- Connection of 2 external electrodes possible



Example application



Veribox

- The Veribox contains resistors for testing high-resistance measuring devices prior to use
- 3 different resistors for testing measuring devices
- Each resistance has a separate plug connection

Surface resistance meter SRM®200

Item no.	Type
ESRM200.K	Handheld meter with case

Item no.
E7100.VB2

ESD workplaces

C-foot workergo with basic frames - conductive





- C-foot basic frame
- Conductive, powdered

- ESD conductive worktop, 30 mm

Item no.	Dimensions in mm (WxDxH)
E07.24.15.30	1500 x 750 x 30
E07.24.20/30	2000 x 750 x 30

Clamp fixing	Item no.	Dimensions in mm (W x D x H)
 	EC150KL75G	1500 x 750 x 670 – 1015
	EC200KL75G	2000 x 750 x 670 – 1015

Crank adjustment	Item no.	Dimensions in mm (W x D x H)
 	EC150KU75G	1500 x 750 x 670 – 1015
	EC200KU75G	2000 x 750 x 670 – 1015

Electric height adjustment, 1 motor	Item no.	Dimensions in mm (WxDxH)
 	EC150E175G	1500 x 750 x 670 – 1015
	EC200E175G	2000 x 750 x 670 – 1015









Electric height adjustment, 2 motors	Item no.	Dimensions in mm (WxDxH)
 	EC150E275G	1500 x 750 x 670 – 1015
	EC200E275G	2000 x 750 x 670 – 1015



■ ESD conductive worktop, 30 mm

- 4-foot basic frame
- Conductive, powdered

Item no.	Dimensions in mm (WxDxH)
E07.24.15.30	1500 x 750 x 30
E07.24.20/30	2000 x 750 x 30
E03.1590.30	1500 x 900 x 30
E03.2090.30	2000 x 900 x 30

Clamp fixing	Item no.	Dimensions in mm (WxDxH)
 	E4150KL75G	1500 x 750 x 670 – 1015
	E4200KL75G	2000 x 750 x 670 – 1015
	E4150KL90G	1500 x 900 x 670 – 1015
	E4200KL90G	2000 x 900 x 670 – 1015
Crank adjustment	Item no.	Dimensions in mm (WxDxH)
 	E4150KU75G	1500 x 750 x 670 – 1015
	E4200KU75G	2000 x 750 x 670 – 1015
	E4150KU90G	1500 x 900 x 670 – 1015
	E4200KU90G	2000 x 900 x 670 – 1015
Electric height adjustment, 1 motor	Item no.	Dimensions in mm (WxDxH)
 	E4150E175G	1500 x 750 x 670 – 1015
	E4200E175G	2000 x 750 x 670 – 1015
	E4150E190G	1500 x 900 x 670 – 1015
	E4200E190G	2000 x 900 x 670 – 1015
Electric height adjustment, 2 motors	Item no.	Dimensions in mm (WxDxH)
 	E4150E275G	1500 x 750 x 670 – 1015
	E4200E275G	2000 x 750 x 670 – 1015
	E4150E290G	1500 x 900 x 670 – 1015
	E4200E290G	2000 x 900 x 670 – 1015

ESD workplaces

C-foot table – conductive



1 workergo C-foot

- Worktop, conductive, 1500 x 750 x 30 mm
- Height adjustment by crank
- Energy board with 2x 2 earthed sockets, 1x network socket, 1x compressed air 1/4"
- Load capacity 200 kg

Item no.	Dimensions in mm (WxDxH)
ESDC150KU75G	1500 x 750 x 700 – 1045

2 Parts trolley

- ESD version, 4x steering caster, thereof 2 with locks, Ø 125 mm
- 1x shelf 320 mm, 1x container strip with boxes
- 12x box: 210 x 330 x 200 mm
- 6x box: 150 x 230 x 125 mm

Item no.	Dimensions in mm (WxDxH)
E07.8310.08K	1000 x 800 x 1476

3 Rotary plate with locking mechanism

- With ribbed rubber mat
- With locking mechanism every 45°

Item no.	Dimensions in mm
E07.60.31	Ø 380, conductive
E07.60.32	Ø 500, conductive



workergo C-foot

- Conductive, powdered
- Worktop, conductive, 1500 x 750 x 30 mm
- Height-adjustable

Multi-board setup

- 2x support column
- 1x perforated wall
- 2x shelf 220 mm, 1x shelf 320 mm
- Pivot arm with keyboard platform, pivot arm with shelf
- Overhead frame with equipment rail and lighting 2x 36W



Item no.	Dimensions in mm (WxDxH)	Height adjustment
EC150KL75-05	1500 x 750 x 700 – 1045	Clamp fixing, load capacity 200 kg
EC150KU75-05	1500 x 750 x 700 – 1045	Crank adjustment, load capacity 200 kg
EC150E175-05	1500 x 750 x 700 – 1045	Electric, 1 motor, load capacity 180 kg
EC150E275-05	1500 x 750 x 700 – 1045	Electric, 2 motors, load capacity 300 kg

Supplied without boxes, hooks and decoration

4-foot table – conductive

ESD workplace systems



-
-
-
-
-

workergo 4-foot

- Conductive, powdered
- Worktop, conductive, 1500 x 750 x 30 mm
- Height-adjustable

Multi-board setup

- 2x support column
- 1x energy bar with 3x earthed sockets and on/off switch
- 2x perforated wall
- 1x shelf, 320 mm
- 1x pivot arm with shelf
- 1x pivot arm with laptop shelf
- Overhead frame with equipment rail and lighting 2x 36W

Item no.	Dimensions in mm (WxDxH)	Height adjustment
E4150KL75-04	1500 x 750 x 700 – 1045	Clamp fixing, load capacity 200 kg
E4150KU75-04	1500 x 750 x 700 – 1045	Crank adjustment, load capacity 200 kg
E4150E175-04	1500 x 750 x 700 – 1045	Electric, 1 motor, load capacity 180 kg
E4150E275-04	1500 x 750 x 700 – 1045	Electric, 2 motors, load capacity 300 kg



-
-
-
-



workraster

- Conductive, powdered
- Worktop, conductive, 1500 x 750 x 30 mm

Multi-board setup

- 2x support column
- 1x energy board with 4x earthed sockets
- 2x perforated wall
- 1x shelf, 320 mm
- Overhead frame with equipment rail and lighting 2x 36W

Item no.	Dimensions in mm (WxDxH)
E07.899.01	1500 x 800 x 2070

Supplied without boxes, hooks and decoration

ESD workplaces

Basic tables - conductive



workline basic table, 1500 mm

- Conductive, powdered
- Worktop, conductive, 1500 x 750 x 30 mm
- Height-adjustable

Multi-board setup

- 2x support column
- 1x magnetic wall
- 1x perforated wall
- 2x inclinable shelf 320 mm
- Overhead frame with equipment rail and lighting 2x 36W



Item no.	Dimensions in mm (WxDxH)	Height adjustment
E07.75.KLMW	1500 x 750 x 765 – 1135	Clamp fixing, load capacity 200 kg
E07.75.KUMW	1500 x 750 x 765 – 1135	Crank adjustment, load capacity 200 kg
E07.75.KHEMW	1500 x 750 x 765 – 1135	Electric, 1 motor, load capacity 180 kg



workline basic table, 1500 mm

- Conductive, powdered
- Worktop, conductive, 1500 x 750 x 30 mm
- Height-adjustable, tabletop form 765 – 1135 mm

1x superstructure frame

- 1x tripod with 2x earthed sockets and 1x halogen lamp
- 1x pivot arm with shelf
- 1x pivot arm with perforated/slotted wall
- 1x footrest

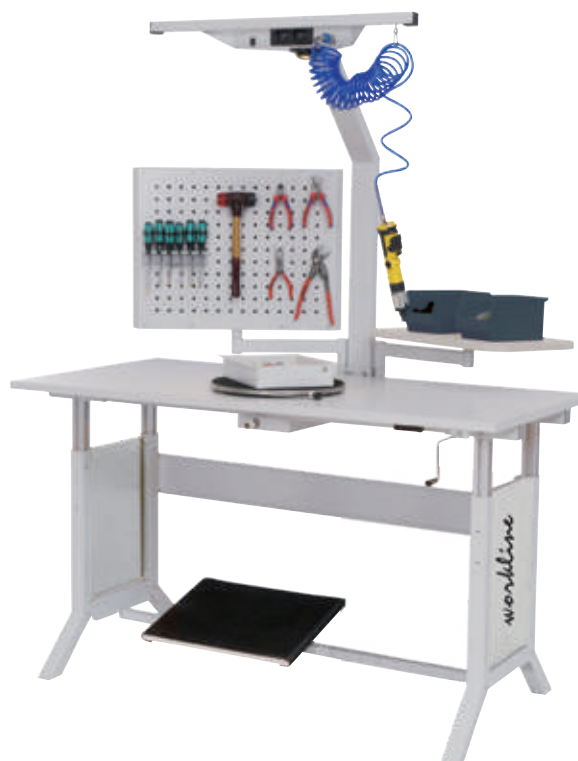

Item no.	Dimensions in mm (WxDxH)	Height adjustment
E07.75.1KLST	1500 x 750 x 765 – 1135	Clamp fixing, load capacity 200 kg
E07.75.1KUST	1500 x 750 x 765 – 1135	Crank adjustment, load capacity 200 kg
E07.75.1KHEST	1500 x 750 x 765 – 1135	Electric, 1 motor, load capacity 180 kg

Supplied without boxes, hooks, rotary plate and decoration

1



Table cover

- 610 x 1220 mm (WxD)

Item no.
E07.24.03

2



Earthing module

- With 2 m smooth cable
- 4 mm eyelet, without resistance

Item no.
E07.24.21

3



Earthing cable, 1.5 m

- For table/floor coverings, 1 MOhm safety resistor
- 10 mm snap fastener/4 mm eyelet, 3 m

Item no.
E07.24.07

6



Wrist strap

- 3 mm snap fastener

Item no.
E07.24.02

4



Spiral cable

- Highly elastic, 2.4 m long, 2x 1 MOhm safety resistance
- Earthing contact connection: 10 mm snap fastener
- Typical resistance $R = 2x 10^6$ Ohm

Item no.
E07.24.04

7



Floor mat

- Ecostat® Mega - 3.5 Rubber
- 1220 x 2500 x 3.5 mm (W x D x H)

Item no.
E07.24.08

8



Connection examples for earthing terminal strip on the rear



5



Earthing box

- As earth bonding point (EBP) for personal grounding, earthing cable
- 2 m long, connection type: 4 mm eyelet, 1 MOhm safety resistor per connection
- 2x 10 mm snap fastener connection
- 1x 4 mm safety socket

Item no.
E07.24.22

8



Earthing terminal strip

Item no.
E07.24.09

Floor coverings

ECOSTAT® standard floor mats

Flooring material for DIY loose laying

Two-layer composite tile flooring

- Volume conductive
- Abrasion-resistant
- Conductive, elastic backing, adapts to the substrate
- Backing with waffle structure for installation on problematic substrates (e.g. residual moisture)
- Suitable for chair castors
- Suitable for forklifts
- Reusable
- Self-laying | **Easy laying thanks to click system**
- Easy handling using woodwork tools
- Can be walked on during laying, therefore very short downtimes
- Colour: Grey
- Typical bleeder resistance $R_{gp} = 10^4 - 10^5$ ohm

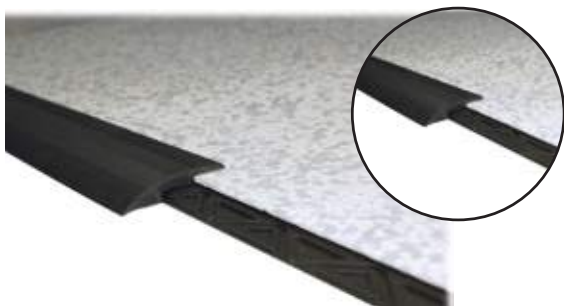

Transition (optional)

- Adhesive, easy laying thanks to click system

Item no.	Standard dimension in mm	Packaging unit
E1310PF701R	1220 x 65	1

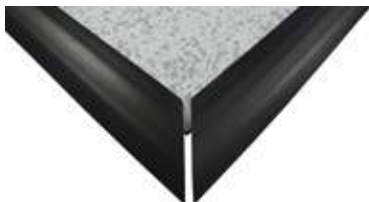

Corner joint (optional)

- Adhesive

Item no.	Standard dimension in mm	Packaging unit
E1310PF701RES	711 x 65	2

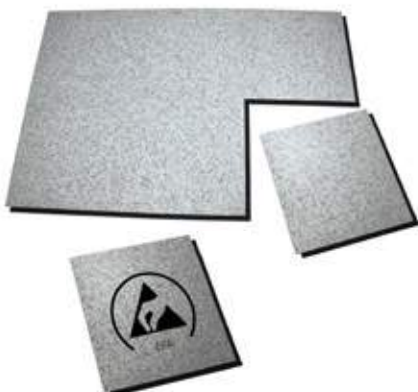

Puzzle tile

Item no.	Dimensions in mm (WxDxH)	Packaging unit
E1310.PF.701	469 x 469 x 8.5	12
E1310.PF.ESD	469 x 469 x 8.5 with ESD logo	1

Standard floor mat

- Rounded corners
- 2x 10 mm snap fastener connection
- Max. roll length 10 m



Incl. earthing cable with protective cap, with 10 mm snap fastener, 4 mm eyelet, 1 MOhm safety resistor, 4.5 m long

ECOSTAT® Mega - 3.5 Rubber

- Adhesive

Item no.	Dimensions in mm (WxDxH)
E1250.681	1220 x 1650 x 3.5
E07.24.08	1220 x 2500 x 3.5

ECOSTAT® PR - 2.0

- Adhesive

Item no.	Dimensions in mm (WxDxH)
E1250.7004.L	1500 x 2000 x 2

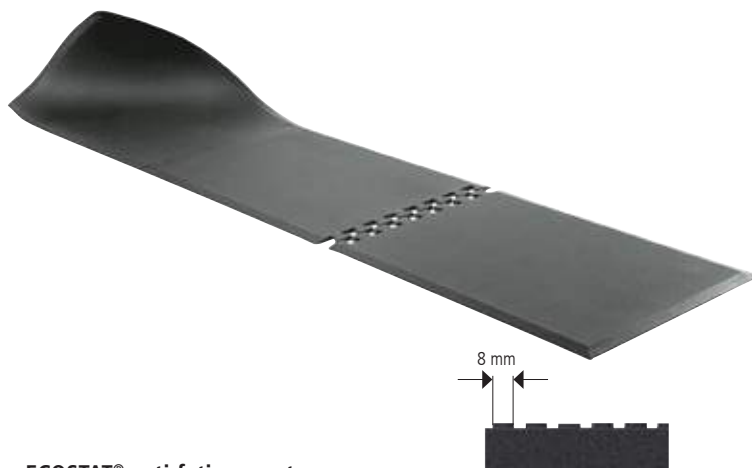

ECOSTAT® anti-fatigue mats

- Improved walking, turning and standing properties
- Tread can be quickly extended as desired using puzzle technology
- Customer-specific dimensions also possible lateral and longitudinal directions with puzzle technology
- Smallest configuration: 2 end tiles
- Blister diameter: 8 mm

Item no.	Dimensions in mm (WxDxH)
E06500940VE	End tile: 650 x 940 x 13 incl. 10 mm snap fastener
E06500910VM	Middle tile: 650 x 910 x 13
E307.B1.Z	Custom size on request

ECOSTAT® table mat

ESD workplace systems

- Two-layer composite flooring
- Rugged synthetic rubber
- Resistant to solder and heat
- Abrasion-resistant
- Halogen-free
- Permanently elastic

- Volume conductive
- Material thickness: 2 mm
- Typical bleeder resistance $R_{gp} = 10^6 - 10^7$ ohm
- Includes: 2x 10 mm snap fastener,
*Rounded corners (radius approx. 43 mm)



Table cover

Item no.	Colour	Dimensions in mm (WxD)
E07.24.03	Platinum grey	1220 x 610
E1402.663.S*	Platinum grey	900 x 610
E1402.663.R	Platinum grey	Rolls: 1220 x 10000

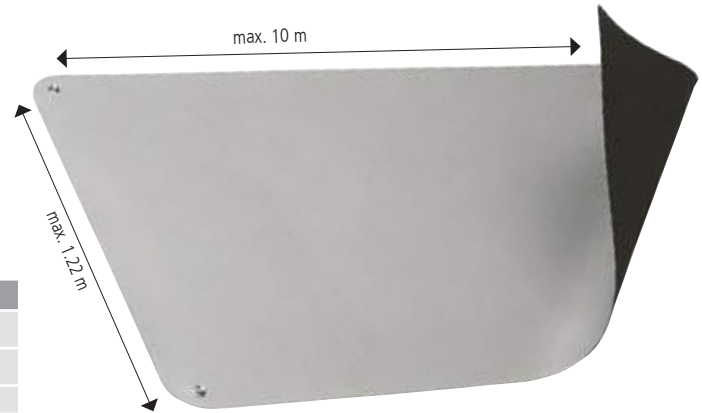

Table cover

Item no.	Colour	Dimensions in mm (WxD)
E1402.665.L*	Light blue	610 x 1220
E1402.665.S*	Light blue	610 x 900
E1402.665.R	Light blue	Rolls: 1220 x 10000



Table cover

Item no.	Colour	Dimensions in mm (WxD)
E1402.662.L*	Beige	610 x 1220
E1402.662.S*	Beige	610 x 900
E1402.662.R	Beige	Rolls: 1220 x 10000

ECOSTAT® shelf mat



Anti-slip covering

- Anti-slip profile in transverse and longitudinal direction - on both sides
- Permanently dissipative due to carbon
- Covering for transport trolleys and shelves
- Profiled, wear-resistant synthetic rubber
- Material thickness: 2 mm

Item no.	Colour	Dimensions in mm (WxD)
E1453.7300.R	Black	Rolls: 1220 x 10000

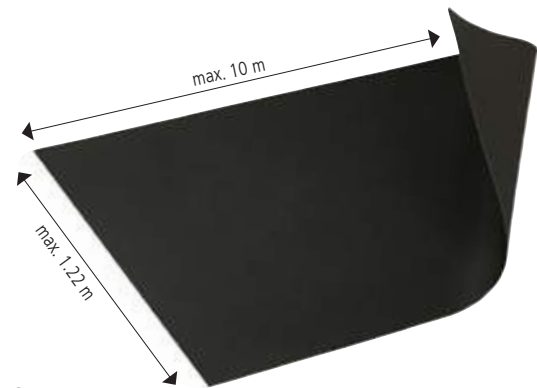

Shelf mat

- Two-layer composite flooring
- Rugged synthetic rubber
- Resistant to solder and heat
- Abrasion-resistant
- Halogen-free
- Permanently elastic
- Volume conductive
- Material thickness: 1.5 mm
- Typical bleeder resistance $R_{gp} = 10^6 - 10^7$ ohm

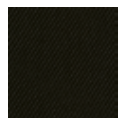

Item no.	Colour	Dimensions in mm (WxD)
E1452.659.R	Black	Rolls: 1220 x 10000

Storage systems

Open fronted storage bins

Open fronted storage bins – conductive

- Carbon-loaded, permanently volume conductive polypropylene
- Improved removal opportunity due to rounded corners
- With ESD labelling
- Typical surface resistance $R_{gp} = 10^4 - 10^5$ ohm



Back



Item no.	External dimensions in mm (WxDxH)	Internal dimensions in mm (WxDxH)	Usable height/stack in mm	Packaging unit
E5320.FA3Z	200 x 350 x 145	182 x 280 x 127	127	12
E5320.FA4	145 x 235 x 125	127 x 180 x 108	108	25
E5320.FA5	100 x 175 x 75	87 x 129 x 67	67	42



- E5320.2 and E5320.3 include a handle

Item no.	External dimensions in mm (WxDxH)	Internal dimensions in mm (WxDxH)	Usable height/stack in mm	Packaging unit
E5320.2	300 x 500 x 200	280 x 425 x 183	183	6
E5320.3	200 x 350 x 200	182 x 280 x 185	185	8
E5320.3Z	200 x 350 x 145	182 x 280 x 127	127	12
E5320.4	145 x 235 x 125	127 x 180 x 108	108	27
E5320.5	100 x 175 x 75	87 x 129 x 67	67	40
E5320.6	100 x 95 x 50	87 x 60 x 44	44	50

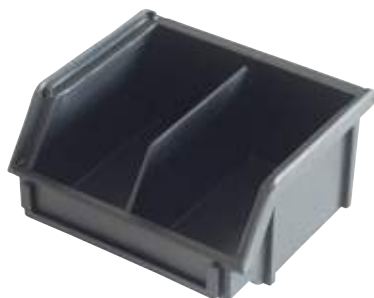

- With separator

Item no.	External dimensions in mm (WxDxH)	Internal dimensions in mm (WxDxH)	Usable height/stack in mm	Packaging unit
E5320.6D	100 x 95 x 50	87 x 60 x 44	44	50

IDP-STAT® open fronted storage bins – conductive

- Permanently volume conductive polypropylene
- Made of Inherently Dissipative Polymer (IDP-STAT®)
- Stackable
- With ESD labelling
- Typical surface resistance $R_{sp} = 10^9 - 10^{10}$ ohm



- Red

Item no.	External dimensions in mm (WxDxH)	Internal dimensions in mm (WxDxH)	Usable height/stack in mm	Packaging unit
E5321.R.4	145 x 235 x 125	127 x 180 x 108	108	27
E5321.R.5	100 x 175 x 75	87 x 129 x 67	67	40
E5321.R.6	100 x 95 x 50	87 x 60 x 44	44	50



- Yellow

Item no.	External dimensions in mm (WxDxH)	Internal dimensions in mm (WxDxH)	Usable height/stack in mm	Packaging unit
E5321.Y.4	145 x 235 x 125	127 x 180 x 108	108	27
E5321.Y.5	100 x 175 x 75	87 x 129 x 67	67	40
E5321.Y.6	100 x 95 x 50	87 x 60 x 44	44	50

Other sizes and colours on request.

**Labels for open fronted storage bins**

Item no.	Suitable for open fronted storage bins	Dimensions in mm (WxD)	Packaging unit
E5320.2.ET	5320.2	82 x 42	100
E5320.3.ET	5320.3	79 x 43	100
E5320.3Z.ET	5320.3Z	79 x 30	100
E5320.4.ET	5320.4 / 5321.R.4 / 5321.Y.4	80 x 29	100
E5320.5.ET	5320.5 / 5321.R.5 / 5321.Y.5	79 x 20	100
E5320.6.ET	5320.6 / 5321.R.6 / 5321.Y.6	79 x 13	100
E5320FA2.3ET	5320.FA2 / 5320.FA3	98 x 43	100
E5320FA3Z.ET	5320.FA3Z	101 x 30	100
E5320.FA4.ET	5320.FA4	74 x 23	100
E5320.FA5.ET	5320.FA5	53 x 15	100

Storage systems

Storage and transport containers - conductive



Storage containers - conductive

- Carbon-loaded, permanently volume conductive polypropylene
- Stackable
- Palette modular size
- With ESD labelling
- Closed handle
- Typical surface resistance $R_{sp} = 10^4 - 10^5$ ohm

Item no.	External dimensions in mm (WxDxH)	Internal dimensions in mm (WxDxH)	Usable height/stack in mm
E5310.05	200 x 300 x 120	170 x 270 x 117	106
E5310.10	300 x 400 x 120	255 x 355 x 115	104
E5310.14	300 x 400 x 170	255 x 355 x 165	152
E5310.20	300 x 400 x 220	255 x 355 x 217	204
E5310.25	300 x 400 x 270	255 x 355 x 265	252
E5310.31	300 x 400 x 320	255 x 355 x 317	304



Item no.	External dimensions in mm (WxDxH)	Internal dimensions in mm (WxDxH)	Usable height/stack in mm
E5310.15	400 x 600 x 75	355 x 555 x 70	56
E5310.24	400 x 600 x 120	355 x 555 x 115	104
E5310.33	400 x 600 x 150	355 x 555 x 145	131
E5310.34	400 x 600 x 170	355 x 555 x 165	152
E5310.42	400 x 600 x 220	355 x 555 x 215	204
E5310.50	400 x 600 x 236	355 x 555 x 231	214
E5310.55	400 x 600 x 280	355 x 555 x 275	261
E5310.70	400 x 600 x 336	355 x 555 x 332	314
E5310.80	400 x 600 x 420	355 x 555 x 415	397

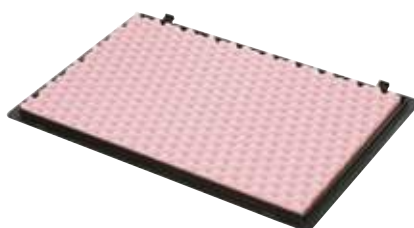

Hinge

Lid with hooks

Lid with hooks

Item no.	External dimensions in mm (WxD)
E5310.43	400 x 300 lid, loose
E5310.64	600 x 400 lid, loose

Item no.	External dimensions in mm (WxD)
E5310.43.PU	400 x 300 lid, loose, with conductive, soft PU foam
E5310.64.PU	600 x 400 lid, loose, with conductive, soft PU foam

Hinged lid

Item no.	External dimensions in mm (WxD)
E5310.32.S	300 x 200 lid, loose
E5310.43.S	400 x 300 lid, loose

IDP-Stat® storage and transport containers - conductive

- Permanently volume conductive polypropylene
- Made of Inherently Dissipative Polymer (IDP-STAT®)
- Stackable
- Palette modular size
- With ESD labelling
- Closed handle
- Typical surface resistance $R_{sp} = 10^9 - 10^{10}$ ohm



■ Yellow

Item no.	External dimensions in mm (LxWxH)	Internal dimensions in mm (LxWxH)	Usable height/stack in mm
E5311.Y.10	300 x 400 x 120	255 x 355 x 115	104
E5311.Y.14	300 x 400 x 170	255 x 355 x 165	152
E5311.Y.20	300 x 400 x 220	255 x 355 x 217	204

■ Red

E5311.R.10	300 x 400 x 120	255 x 355 x 115	104
E5311.R.14	300 x 400 x 170	255 x 355 x 165	152
E5311.R.20	300 x 400 x 220	255 x 355 x 217	204



■ Yellow

Item no.	External dimensions in mm (LxWxH)	Internal dimensions in mm (LxWxH)	Usable height/stack in mm
E5311.Y.24	400 x 600 x 120	355 x 555 x 115	104
E5311.Y.34	400 x 600 x 170	355 x 555 x 165	152
E5311.Y.42	400 x 600 x 220	355 x 555 x 215	204

■ Red

E5311.R.24	400 x 600 x 120	355 x 555 x 115	104
E5311.R.34	400 x 600 x 170	355 x 555 x 165	152
E5311.R.42	400 x 600 x 220	355 x 555 x 215	204

**Lid with hooks**

■ Yellow

Item no.	External dimensions in mm (WxD)
E5311.Y.43	400 x 300 lid, loose
E5311.Y.64	600 x 400 lid, loose

Lid with hooks

■ Red

Item no.	External dimensions in mm (WxD)
E5311.R.43	400 x 300 lid, loose
E5311.R.64	600 x 400 lid, loose



ESD parts trolley

Multi-trolley combinations from practice – conductive



Multi-trolley

- Equipped with 2x fixed and 2x steering caster with locks, Ø 125 mm
- Bottom shelf
- 8x inclinable shelf 320 mm depth
- Total load capacity 500 kg

Includes

- 6x Euro storage bins 400 x 300 x 170 mm
- 8x open fronted storage bin 200 x 350 x 200 mm
- 16x open fronted storage bin 200 x 350 x 145 mm

Item no.	Dimensions in mm (WxDxH)
ESD07.58.14	990 x 610 x 1450



Multi-trolley

- Equipped with 2x fixed and 2x steering caster with locks, Ø 125 mm
- 4x inclinable shelf 320 mm depth
- 2x perforated panel, 302 mm
- Total load capacity 500 kg

Includes

- 6x Euro storage bins 400 x 300 x 170 mm
- 8x open fronted storage bin 200 x 350 x 145 mm
- Supplied without tools

Item no.	Dimensions in mm (WxDxH)
ESD07.58.16	990 x 610 x 1450



Multi-trolley

- Equipped with 2x fixed and 2x steering caster with locks, Ø 125 mm
- Open fronted storage bins are hung in rails
- Total load capacity 500 kg

Includes

- 32x open fronted storage bin 100 x 170 x 80 mm
- 24x open fronted storage bin 145 x 230 x 125 mm
- 16x open fronted storage bin 200 x 350 x 200 mm

Item no.	Dimensions in mm (WxDxH)
ESD07.58.12	990 x 610 x 1450



Multi-trolley

- Equipped with 2x fixed and 2x steering caster with locks, Ø 125 mm
- 4x inclinable shelf 420 mm depth
- Total load capacity 500 kg

Includes

- 8x Euro storage bins 400 x 600 x 170 mm

Item no.	Dimensions in mm (WxDxH)
ESD07.58.18	990 x 610 x 1450

Individual parts trolleys on request.



Vinyl roller stool

- Dissipative roller stool with height adjustment
- For clean production areas
- 5-star cruciform base made of chrome-plated aluminium with 5 conductive, load-dependent braked, soft castors
- Safety gas spring
- Seat height adjustment from 500 to 640 mm
- Durable and conductive vinyl cover, seat diameter: 340 mm
- With ESD labelling

Item no.	Type
E1700.VH	Black
E1700.KS.13	Hard, conductive chair castors (for carpeted floors)



Backrest with ESD labelling



PU sit-stand stool

- Dissipative sit-stand stool with height adjustment
- Dissipative and robust construction with anti-skid glides
- Lockable seat height adjustment
- 15° tilting seat
- Dissipative and durable PU integral foam seat
- 16° tilting seat for excellent body contact
- GS tested
- With ESD labelling
- Typical bleeder resistance $R_{gp} = 10^8 - 10^9 \text{ ohm}$

Item no.	Colour
E1700.S	Black

The INDUSTRIAL PU chair provides excellent, ergonomic sitting comfort. It reliably and safely drains static charges from personnel to the conductive flooring or floor mat.



Standard version

- 5-star cruciform base made of chrome-plated aluminium with 5 conductive, load-dependent braked, soft castors
- Safety gas spring
- Seat height adjustment from 380 to 510 mm
- Synchronous adjustment of seat and backrest
- Seat and backrest made of durable, black conductive PU integral foam
- PU integral foam is easy to clean
- With ESD labelling
- GS tested

Item no.	Type
E1700.PU	Without armrests



Backrest with ESD labelling



High model

- Seat height from 540 to 800 mm
- Cruciform base with 5 conductive glides
- Chrome-plated foot ring as climbing aid
- Stepless height adjustment

Item no.	Type
E1710.PU	Without armrests

Optional accessories

Item no.	Type
E1700.KS.13	Hard, conductive chair castors (for carpeted floors)
E1700.XS.PU	Volume conductive PU armrests* incl. mounting plate

Chair

Comfort chair

The COMFORT chair provides an exceptional sitting comfort due to its highly resilient foam contoured seat. It reliably and safely drains static charges from personnel to the conductive flooring or floor mat.



Backrest with ESD labelling



Standard version

- 5-star cruciform base made of chrome-plated aluminium with 5 conductive, load-dependent braked, soft castors
- Safety gas spring
- Seat height adjustment from 400 to 420 mm
- Asynchronous mechanism
- Seat and dynamic back rest individually adjustable
- Hard-wearing and conductive upholstery cover for the seat and backrest in fabric
- Conductive plastic back seat shell with ESD labelling
- GS tested

Item no.	Colour	Type
E1700.ES.B	Blue	Without armrests
E1700.ES.D	Grey	Without armrests

High model

- Seat height from 640 to 760 mm
- Cruciform base with 5 conductive glides, foot ring as climbing aid

Item no.	Colour	Type
E1710.ES.B	Blue	Without armrests
E1710.ES.D	Grey	Without armrests

Optional accessories

Item no.	Type
E1700.KS.13	Hard, conductive chair castors (for carpeted floors)
E1700.XS	Volume conductive PU armrests*

The high-quality COMFORT PLUS chair provides perfect, ergonomic sitting comfort due to its foam contoured seat. It reliably and safely drains static charges from personnel to the conductive flooring or floor mat.



Backrest with ESD
labelling



Standard version

- 5-star cruciform base made of polished aluminium with 5 conductive, load-dependent braked, soft castors
- Safety gas spring
- Seat height adjustment from 430 to 540 mm
- Adjustable back height
- Adjustable back height, depth and angle
- Mechanism with synchronous technology ensures active-dynamic sitting
- Seat and dynamic back rest individually adjustable
- High-quality moulded foam pads for perfect sitting comfort
- Hard-wearing and conductive black upholstery cover
- Conductive plastic back seat shell
- With ESD labelling
- GS tested

Item no.	Colour	Type
E1700.ESP.S	Black	Without armrests

High model

- Seat height from 610 to 850 mm
- Cruciform base with 5 conductive glides
- Chrome-plated foot ring as climbing aid
- Stepless height adjustment

Item no.	Colour	Type
E1710.ESP.S	Black	Without armrests

Optional accessories

Item no.	Type
E1700.KS.13	Hard, conductive chair castors (for carpeted floors)
E1700.XS	Volume conductive PU armrests*



Mobile logistics systems





Caster types

Page 458



maxmobile 1, maxmobile 2

Page 460



Drawer tool sets

Page 470



Mobile drawer cabinets

Page 474



Mobile workbenches

Page 486



Mobile computer, measuring and testing stations

Page 496



Multi-trolleys, parts trolleys

Page 504



New

Other mobile units

Page 510



Mobile workraster unit

Page 524



Mobile workergo unit

Page 528



Mobile workline unit

Page 529





Caster types for drawer cabinets

- For safety reasons, the maximum total load for a set of casters is 75% of the indicated load capacity



04ST500L80



04ST500LF80



04ST736B80



04ST736L80



04ST736LF80

Casters for T500 mobile drawer cabinets

- Steering caster with back hole, Ø 80 mm
- Load capacity per caster 50 kg

Item no.	Version
04ST500L80	Steering caster without lock
04ST500LF80	Steering caster with lock

Casters for T736 mobile drawer cabinets

- Fixed and steering caster with screw-on plate, Ø 80 mm
- Wheel made of high-quality, unbreakable polyamide 6, natural white
- Load capacity per caster 200 kg

Item no.	Version
04ST736B80	Fixed caster
04ST736L80	Steering caster without lock
04ST736LF80	Steering caster with lock



04SWEL125



04SWELF125



04ST736B125



04ST736L125



04ST736LF125

Casters for T500 mobile drawer cabinets

- Steering caster with back hole, Ø 125 mm
- Wheel made of high-quality elastic solid rubber
- Quiet running, low roll resistance, very gentle on floors
- Load capacity per caster 150 kg

Item no.	Version
04SWEL125	Steering caster without lock
04SWELF125	Steering caster with lock

Casters for T736 mobile drawer cabinets

- Fixed and steering caster with screw-on plate, Ø 125 mm
- Wheel made of high-quality elastic solid rubber
- Quiet running, low roll resistance, very gentle on floors
- Load capacity per caster 150 kg

Item no.	Version
04ST736B125	Fixed caster
04ST736L125	Steering caster without lock
04ST736LF125	Steering caster with lock

Caster types for workbenches



- For safety reasons, the maximum total load for a set of casters is 75% of the indicated load capacity



04SWEL125

04SWELF125



04WB200

04WL200

04WLF200

Casters for T500 and T750 mobile workbenches

- Steering caster with back hole, Ø 125 mm
- Wheel made of high-quality elastic solid rubber
- Quiet running, low roll resistance, very gentle on floors
- Load capacity per caster 150 kg

Item no.	Version
04SWEL125	Steering caster without lock
04SWELF125	Steering caster with lock

Casters for T750 mobile box workbenches

- Fixed and steering caster with screw-on plate, Ø 200 mm
- Wheel made of standard solid rubber
- Very high driving comfort, quiet running, very gentle on floors
- Load capacity per caster 205 kg

Item no.	Version
04WB200	Fixed caster
04WL200	Steering caster without lock
04WLF200	Steering caster with lock

maxmobile 1 and workergo series



04MB100

04ML100

04MLF100



4XXXXXMB100

4XXXXXMLF100

Casters for maxmobile 1

- Fixed and steering caster with back hole, Ø 100 mm
- Wheel made of high-quality thermoplastic rubber elastomer (TPE)
- High driving comfort, quiet running, low roll and swivel resistance, gentle on floors
- Load capacity per caster 110 kg

Item no.	Version
04MB100	Fixed caster
04ML100	Steering caster without lock
04MLF100	Steering caster with lock

workergo series expander casters

- Fixed and steering caster, Ø 100 mm
- Wheel made of high-quality thermoplastic rubber elastomer (TPE)
- High driving comfort, quiet running, low roll and swivel resistance, gentle on floors
- Load capacity per caster 110 kg

Item no.	Version
4XXXXXMB100	Fixed caster
4XXXXXML100	Steering caster without lock
4XXXXXMLF100	Steering caster with lock

Mobile logistics systems

maxmobile 1 and 2

maxmobile

Series	Series
maxmobile 1	maxmobile 2



Height	Housing W x D	Housing W x D
	Usable heights	Usable heights
208	630 x 390	630 x 490
215	–	–
358	–	–
365	–	–
465	–	–
469	–	–
500	–	–
519	–	–
619	–	–
719	600	600
819	–	–
919	–	–
1019	–	–
1319	–	–
1519	–	–



Height	Drawer W x D	Drawer W x D
	Load capacity	Load capacity
50	600 x 300	600 x 400
75	35 kg	35 kg
100	35 kg	35 kg
125	–	–
150	35 kg	35 kg
175	–	–
200	35 kg	35 kg
250	–	–
300	–	–
400	–	–



Series	Series
maxmobile 1	maxmobile 2
T390 24-12	T490 24-16

Grid:	R 24-12	R 24-16
-------	---------	---------

Grid subdivision

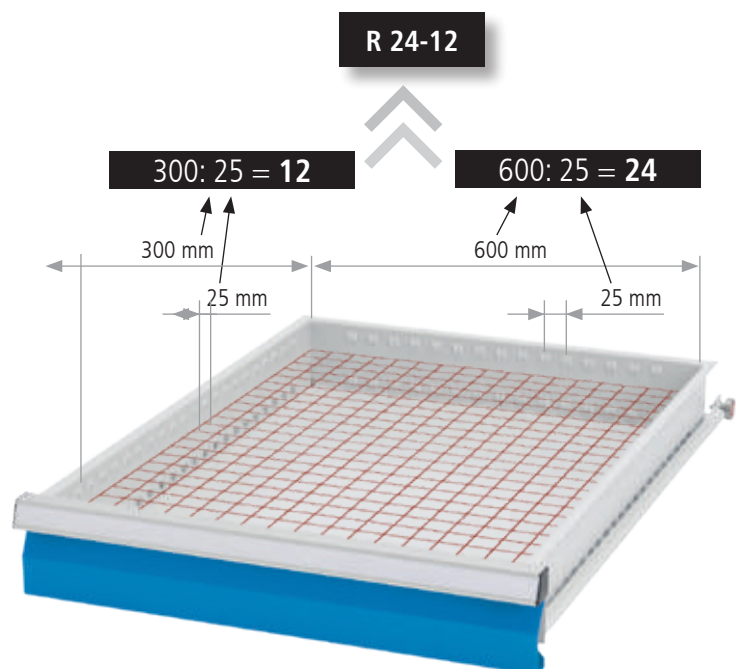

maxmobile 1 and 2

Mobile logistics systems

- Internal usable area: 600 x 300 mm
- Drawers with full pull-out (FP) 100 %, load capacity 35 kg
- Supplied without decoration, tools and hooks



maxmobile 1

- 5x drawer
- 2x fixed and 2x steering caster with locks, Ø 100 mm
- 1x waste bin, 1x bottle and can holder
- 1x support tray, 1x wooden panel, 1x side cover panel
- 1x swivelling laptop tray
- 1x perforated wall setup 300 mm with swivelling side parts

Item no.	Dimensions in mm (WxDxH)
08.88.90-1	780 x 480 x 1540



maxmobile 2

- 6x drawer
- Axle with 2x fixed caster, Ø 150 mm, 2x steering caster with lock, Ø 100 mm
- 1x waste bin, 1x bottle and can holder
- 1x support tray, 1x wooden panel, 1x side flap
- 1x swivelling laptop tray
- 1x perforated wall setup 300 mm with swivelling side parts

Item no.	Dimensions in mm (WxDxH)
08.89.92-1	780 x 580 x 1540



maxmobile 2

- 5x drawer
- Axle with 2x fixed caster, Ø 150 mm, 2x steering caster with lock, Ø 100 mm
- 1x bottle and can holder
- 1x waste bin, 1x support tray, 1x wooden panel, 1x side flap
- 1x swivelling laptop tray

Item no.	Dimensions in mm (WxDxH)
08.89.90-1	780 x 580 x 912



maxmobile 2

- 5x drawer
- 1x waste bin, 1x support tray, 1x wooden panel, 1x side cover panel
- 1x swivelling laptop tray
- Axle with 2x fixed caster, Ø 150 mm, 2x steering caster with lock, Ø 100 mm
- 1x perforated wall setup 600 mm with swivelling side walls

Item no.	Dimensions in mm (WxDxH)
087.89.303-2	780 x 580 x 1540

maxmobile 1



maxmobile 1

maxmobile 1



- Internal usable area: 600 x 300 mm
- 100 % full pull-out of drawers with max. 35 kg load capacity
- Central locking
- Precise locking and self-retraction
- Circumferential impact and heel protection
- 2x fixed and 2x steering caster with locks, Ø 100 mm
- Comprehensive range of divider material
- Wide range of accessories for every application
- Plastic support surface with moulded surfaces for small parts and ergonomic handles
- Support surface is highly resistant to chemicals and oil
- Support surface in either plastic or beech multiplex version
- Powder coating in 15 standard colours (colour combinations possible)

Your advantages:

- Space-saving
- Small and manoeuvrable
- Comfortable, safe ride
- Theft-proof central locking with "B+H" locking system
- Wide range of accessories for every application
- Comprehensive range of divider material
- Individual configuration
- Eco-friendly painting procedure
- No risk of injury from snagging



maxmobile 1

- 2x hinged door
- 1x internal perforated wall on each side
- 1x shelf

Item no.	Dimensions in mm (WxDxH)
08.88.03	780 x 480 x 912



maxmobile 1

- 6x drawer
- 1x side cover panel

Item no.	Dimensions in mm (WxDxH)
08.88.93	780 x 480 x 912



maxmobile 1

- 6x drawer
- 1x side cover panel

Item no.	Dimensions in mm (WxDxH)
08.88.92	780 x 480 x 912

maxmobile 1



maxmobile 1

- 4x drawer
- 1x side cover panel

Item no.	Dimensions in mm (WxDxH)
08.88.91	780 x 480 x 912

Individual arrangement

2x hinged door with lock

- Cylinder lock with central locking

Item no.	Usable heights (mm)
08.88.FLGSE	600



Support rail for open fronted storage bins

- For hanging on the perforated wall

Item no.	Width in mm
03.900.06	300
03.900.05	450



Open fronted storage bins

- Polypropylene

Item no.	Dimensions in mm (WxDxH)
03.900.001	100 x 95 / 65 x 50
03.900.002	100 x 175 / 140 x 75
03.900.003	145 x 235 / 195 x 125



Hook assortment

- 10 parts

Item no.
03.87.395-10



Housing with 2x fixed and 2x steering caster with locks, Ø 100 mm

Item no.	Dimensions in mm (WxDxH)	Usable height in mm
08.88.10	780 x 480 x 912	600

Drawers

- 600 x 300 mm (W x D) with full pull-out 100 % – 35 kg

Item no.	Front height	Shell height	Usable height	Load capacity
08.88.60	50	35	40	35 kg
08.88.64	75	60	65	35 kg
08.88.61	100	85	90	35 kg
08.88.62	150	135	140	35 kg
08.88.63	200	185	190	35 kg

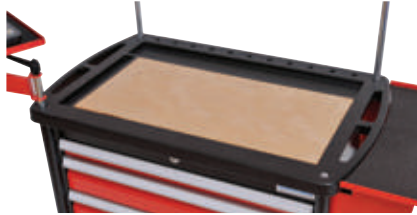

Beech multiplex panel

- For inserting in the plastic storage area

Item no.	Dimensions in mm (WxDxH)
08.88.70	570 x 280 x 15



Support tray

- With paper roll holder

Item no.	Dimensions in mm (WxD)
08.88.72	435 x 200



Swivelling laptop tray

- With locking

Item no.	Dimensions in mm (WxD)
08.88.73	300 x 420



Bottle and can holder

- Hung on the side

Item no.	Dimensions in mm (WxDxH)
08.88.74	380 x 90 x 85



Document holder

- Hung on the side

Item no.	Dimensions in mm (WxDxH)
08.88.75	380 x 45 x 190



Waste bin

- Hung on the side

Item no.	Dimensions in mm (WxDxH)
08.88.76	375 x 170 x 150



Perforated wall setup

- With swivelling side parts

Item no.	Dimensions in mm (W x H)
08.88.77	1250 x 300
08.89.50	1380 x 600

- Without swivelling side walls

Item no.	Dimensions in mm (W x H)
08.88.89	630 x 300
08.89.51	630 x 568



Perforated side wall

- Hung on the side

Item no.	Dimensions in mm (WxDxH)
08.88.79	388 x 15 x 712



Side cover panel

- Semi-circular, hung on the side

Item no.	Dimensions in mm (WxDxH)
08.88.81	388 x 15 x 712

Drawer inserts R 24-12, internal dimensions 600 x 300 mm



- 2x TP with 2 troughs
- 4x TP with 3 troughs
- 2x TP with 4 troughs
- 4x SDIV for 2 troughs
- 12x SDIV for 3 troughs
- 8x SDIV for 4 troughs

Item no.	Front
08.88.30	50

- Foam mat

Item no.	Front
08.88.41	100

- 3x CCR 300 mm
- 8x DIV 150 mm

Item no.	Front
08.88.36	100
08.88.37	150
08.88.42	200

- 2x CCR 300 mm
- 6x DIV 200 mm

Item no.	Front
08.88.38	100
08.88.39	150
08.88.43	200

- 4x SPB 150 x 150 mm
- 6x SPB 75 x 150 mm
- 4x SPB 75 x 75 mm

Item no.	Front
08.88.34	50
08.88.35	100

CCR = Centre compartment rails, DIV = Divider, SPB = Small Parts Box, TP = Trough Plate, SDIV = Slot-in divider

maxmobile 2



maxmobile 2

maxmobile 2



- Drawer interior dimension 600 x 400 mm
- 100 % full pull-out of drawers with max. 35 kg load capacity
- Central locking
- Precise locking and self-retraction
- Circumferential impact and heel protection
- Axle with 2x fixed caster, Ø 150 mm, 2x steering caster with lock, Ø 100 mm
- Comprehensive range of divider material
- Wide range of accessories for every application
- Plastic support surface with moulded surfaces for small parts and ergonomic handles
- Support surface is highly resistant to chemicals and oil
- Side cover for the storage of long tools
- Support surface in either plastic or beech multiplex version
- Powder coating in 15 standard colours (colour combinations possible)

Your advantages:

- Reinforced wheel set for higher load
- maxmobile 2 offers 25% more volume
- Larger storage shelves
- More storage space
- Theft-proof central locking with "B+H locking system"
- Wide range of accessories for every application
- Individual configuration
- No risk of injury from snagging

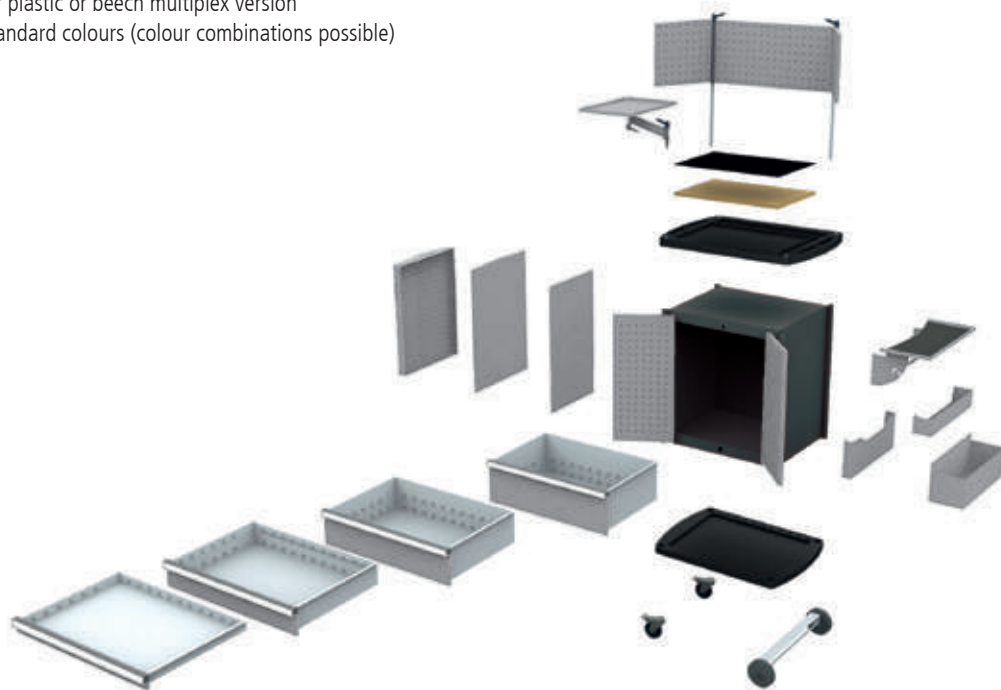

- maxmobile 2**
- 4x drawer
 - 1x side cover panel

Item no.	Dimensions in mm (WxDxH)
08.89.91	780 x 580 x 912



- maxmobile 2**
- 6x drawer
 - 1x side cover panel

Item no.	Dimensions in mm (WxDxH)
08.89.93	780 x 580 x 912



- maxmobile 2**
- 6x drawer
 - 1x side cover panel

Item no.	Dimensions in mm (WxDxH)
08.89.92	780 x 580 x 912

maxmobile 2



maxmobile 2

- 2x hinged door, each with 1x internal perforated wall
- 1x shelf
- 1x internal perforated wall on each side

Item no.	Dimensions in mm (WxDxH)
08.89.03	780 x 580 x 912

Individual arrangement

2x hinged door with lock

- Cylinder lock with central locking

Item no.	Usable heights (mm)
08.88.FLGSE	600



Side flap

- For long tools

Item no.	Dimensions in mm (WxDxH)
08.89.88	490 x 70 x 600



Anti-slip mat insert

- For inserting in the plastic storage area

Item no.	Dimensions in mm (WxDxH)
08.89.71	570 x 380 x 3



Housing with 2x caster, Ø 150 mm, 2x steering caster with lock, Ø 100 mm

- Total height = 600 mm usable height + 119 mm + 150 mm

Item no.	Dimensions in mm (WxDxH)	Usable height in mm
08.89.10	780 x 580 x 912	600

Drawers

- 600 x 400 mm (W x D) with full pull-out 100 % – 50 kg

Item no.	Front height	Shell height	Usable height	Load capacity
08.89.60	50	35	40	50 kg
08.89.59	75	59	60	50 kg
08.89.61	100	85	90	50 kg
08.89.62	150	135	140	50 kg
08.89.63	200	185	190	50 kg



Beech multiplex panel

- For inserting in the plastic storage area

Item no.	Dimensions in mm (WxDxH)
08.89.70	570 x 380 x 15



Support tray

- With paper roll holder

Item no.	Dimensions in mm
08.89.72	535 x 200



Swivelling laptop tray

- With locking

Item no.	Dimensions in mm
08.88.73	300 x 420



Bottle and can holder

- Hung on the side

Item no.	Dimensions in mm (WxDxH)
08.89.74	480 x 90 x 85



Document holder

- Hung on the side

Item no.	Dimensions in mm (WxDxH)
08.89.75	480 x 45 x 190



Waste bin

- Hung on the side

Item no.	Dimensions in mm (WxDxH)
08.89.76	475 x 170 x 150



Perforated wall setup

- With swivelling side parts

Item no.	Dimensions in mm (W x H)
08.88.77	1250 x 300
08.89.50	1380 x 600

- Without swivelling side walls

Item no.	Dimensions in mm (W x H)
08.88.89	630 x 300
08.89.51	630 x 568



Perforated side wall

- Hung on the side

Item no.	Dimensions in mm (WxDxH)
08.89.79	488 x 15 x 712



Side cover panel

- Semi-circular, hung on the side

Item no.	Dimensions in mm (WxDxH)
08.89.81	488 x 15 x 712

Drawer inserts R 24-16, internal dimensions 600 x 400 mm



- 2x CCR 400 mm
- 5x DIV 200 mm

Item no.	Front
168-136-100	100
168-136-150	150
168-136-200	200



- 5x SPB 150 x 150 mm
- 4x SPB 75 x 150 mm
- 4x SPB 75 x 75 mm
- 1x DIV 600 mm
- 2x DIV 100 mm

Item no.	Front
168-132	100



- 3x CCR 400 mm
- 8x DIV 150 mm

Item no.	Front
168-139-100	100
168-139-150	150
168-139-200	200

CCR = Centre compartment rails, DIV = Divider, SPB = Small Parts Box, TP = Trough Plate, SDIV = Slot-in divider

Drawer tool sets

maxmobile 1 drawer tool sets

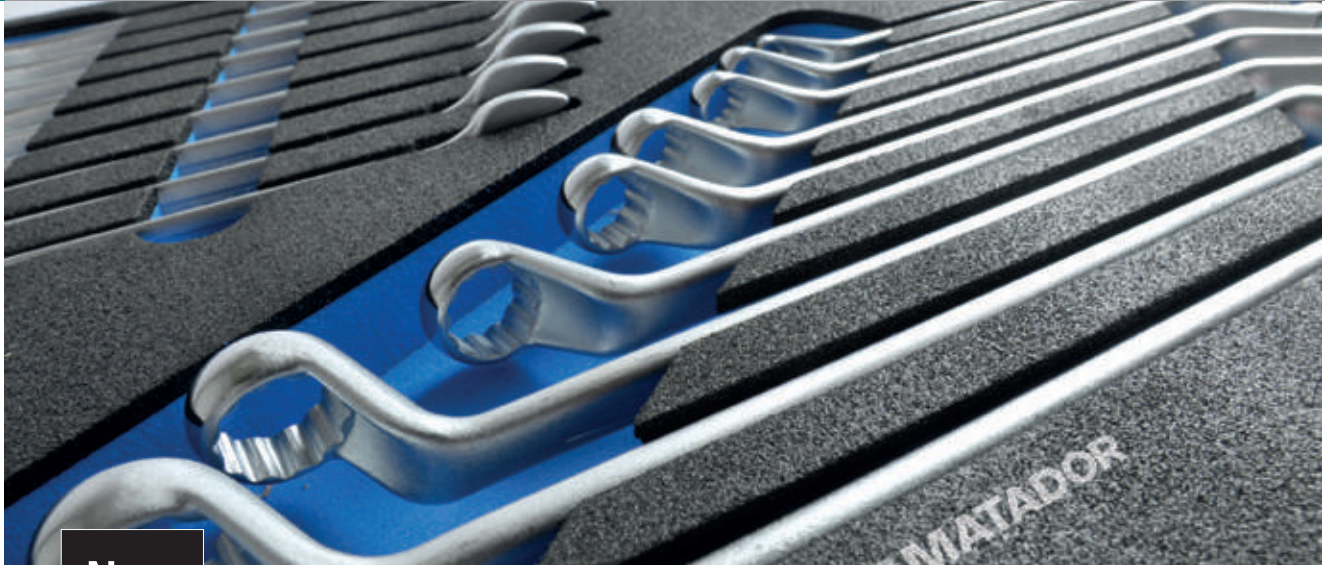

New



Set of turbular hexagon box spanner and double-end box wrench, 15 pcs.

- Turbular hexagon box spanner, DIN 896, Version B 6 x 7, 8 x 9, 10 x 11, 12 x 13, 14 x 15, 16 x 17, 18 x 19, 20 x 22 mm
- Mandrel, 5-fold
- Jaw spanner, adjustable to SW 30, 10"/ 250 mm
- Double-end box wrench 8 x 10, 10 x 12, 11 x 13, 14 x 17, 19 x 22 mm

Item no.	Dimensions in mm (WxD)
08.88.207	565 x 300



Set of T-handle screwdrivers, 15 pcs.

- Inlet two-coloured black/blue
- Hex T-handle screwdriver, DIN 911, 2, 3, 4, 5, 6, 8, 10 mm
- T-handle screwdriver, internal Torx TX 10, 15, 20, 25, 27, 30, 40, 45

Item no.	Dimensions in mm (WxD)
08.88.200	565 x 300

Accessories for individual configuration of maxmobile 1 and 2



Cutting tool, 50 mm

- Flat wide tool for individual creation of inlets

Item no.	Dimensions in mm
08.90.01	50 mm



Cutting tool, 20 mm

- Flat small tool for individual creation of inlets

Item no.	Dimensions in mm
08.90.02	20 mm



Cutting tool, 20 x 20 mm

- Semicircular tool for individual creation of inlets

Item no.	Dimensions in mm
08.90.03	20 x 20



Inlet, untreated

- 2 colours: blue 5 mm, black 20 mm height

Item no.	W x D in mm
08.90.10	600 x 300
08.90.11	600 x 400

**Set of hammers, files, chisels and saws, 16 pcs.**

- Inlet two-coloured black/blue
- Fitter's hammer, DIN 1041, 500 g
- Plastic embossing and dinging hammer, 32 mm
- Engineer's file, DIN 7261 A, 200 mm flat, triangular, round, square and half-round
- Metal saw frame, 250 mm
- Tool set, 6 pcs., plastic feeler gauge, 100 mm sheet, bolted, 20 x 2 – 40/100
- Steel tape measure 3 m

Item no.	Dimensions in mm (WxD)
08.88.203	565 x 300

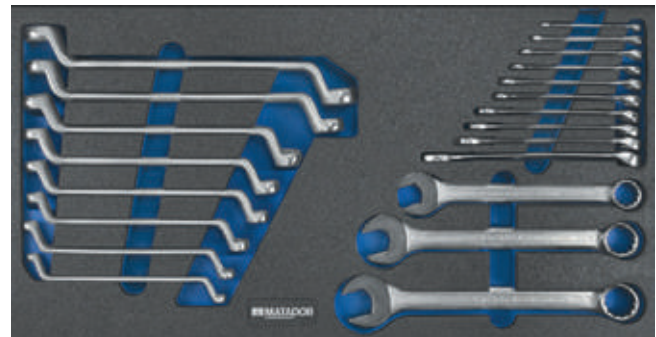
**Key set, 21 pcs.**

- Inlet two-coloured black/blue
- Combination spanner DIN 3113 A, 6, 7, 8, 9, 10, 11, 12, 13, 14, 17, 19, 22, 24 mm
- Double-ended ring spanners, DIN 838 6 x 7, 8 x 9, 10 x 11, 12 x 13, 14 x 15, 16 x 17, 18 x 19, 20 x 22 mm

Item no.	Dimensions in mm (WxD)
08.88.204	565 x 300

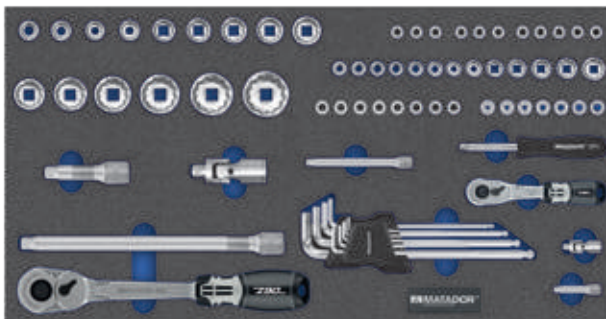
**Set of 1/4"-12" socket keys, 71 pcs.**

- Inlet two-coloured black/blue
- 1/2" reversible ratchet, 270 mm
- 1/2" extension, 75 and 250 mm
- 1/2" cardan joint, 75 mm
- 1/2" hex socket 10, 11, 12, 13, 14, 15, 16, 17, 19, 22, 24, 27, 30, 32 mm
- 1/4" reversible ratchet, safety extension, 140 mm
- 1/4" extension, DIN 3123, 50 and 100 mm
- 1/4" drive handle, DIN 3122, 150 mm
- 1/4" hex socket 4, 4.5, 5, 5.5, 6, 7, 8, 9, 10, 11, 12, 13, 14 mm
- 1/4" internal Torx socket, TX 8, 10, 15, 20, 25, 27, 30, 40
- 1/4" external Torx socket, E 4, 5, 6, 7, 8, 10, 11
- 1/4" cross-head socket, PH 1, 2, 3
- 1/4" slot drive socket, 4 x 25, 5,5 x 25, 7 x 25 mm
- Angled hex key, long, ball head, 9 pcs. 1.5 – 10 mm

Item no.	Dimensions in mm (WxD)
08.88.205	565 x 300

**Set of pliers/screwdrivers, 14 pcs.**

- Inlet two-coloured black/blue
- Cross-head screwdriver, Pozidriv, DIN ISO 8764-1/-2, PZ 1, 2, 3
- Cross-head screwdriver, DIN ISO 8764-1/-2, PH 1, 2, 3
- Workshop screwdriver, DIN 5265, D, 6,5 x 150, 5,5 x 125, 6,5 x 125 mm
- Water pump pliers, ISO 8976, B, 240 mm
- High leverage combination pliers, DIN ISO 5746, 7" / 180 mm
- Diagonal cutter, DIN ISO 5749, 6.1/4" / 160 mm
- Telephone pliers, ISO 5745, straight, 6.3/4" / 170 mm
- Universal grip pliers, 10" / 250 mm

Item no.	Dimensions in mm (WxD)
08.88.206	565 x 300



Drawer tool sets

maxmobile 2 drawer tool sets

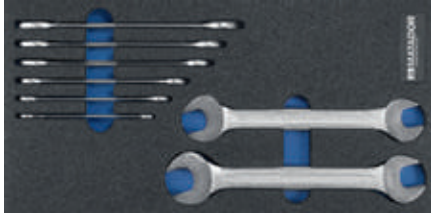

Set of spanners, 100, 8 pcs.

- Inlet two-coloured black/blue
- Double open-ended spanner DIN 3110 6 x 7, 8 x 9, 10 x 11, 12 x 13, 14 x 15, 16 x 17, 18 x 19, 20 x 22 mm

Item no.	Dimensions in mm
08.89.200	400 x 200



Set of spanners, 185, 8 pcs.

- Inlet two-coloured black/blue
- Combination spanner, DIN 3113 A 8, 10, 11, 13, 14, 17, 19, 22 mm

Item no.	Dimensions in mm
08.89.201	400 x 200



Set of spanners, 190, 8 pcs.

- Inlet two-coloured black/blue
- Combination spanner, DIN 3113 B 8, 10, 11, 13, 14, 17, 19, 22 mm

Item no.	Dimensions in mm (WxD)
08.89.202	400 x 200



Set of hammers, chisels and drift punches, 11 pcs.

- Inlet two-coloured black/blue
- Fitter's hammer, DIN 1041, 500 g
- Flat chisel, DIN 6453, form A, 150 and 200 mm
- Centre punch, pin punch, DIN 6450, form C, 3, 4, 5, 6 mm
- Suprabeam Q1 LED tube light
- Snap-off knife, 18 mm
- Steel tape measure 3 m

Item no.	Dimensions in mm (WxD)
08.89.203	400 x 200

Set of 1/4" socket keys, 84 pcs.

- Inlet two-coloured black/blue 1/4" reversible ratchet
- Safety extension, 140 mm, 1/4" sliding T-handle, DIN 3122, 115 mm
- 1/4" cardan joint, DIN 3123, 37 mm
- 1/4" extension, DIN 3123, 50 and 100 mm
- 1/4" drive handle, DIN 3122, 150 mm
- 1/4" hex socket 4, 4.5, 5, 5.5, 6, 7, 8, 9, 10, 11, 13 mm
- 1/4" slot drive socket, 4 x 25, 5,5 x 25, 7 x 25 mm
- 1/4" cross-head socket, PH 1, 2, 3
- 1/4" hex socket, 3, 4, 5, 6, 8 mm
- 1/4" connector, A/M 3/8" - 1/4", 1/4" insert
- External Torx, E 4, 5, 6, 7, 8, 10, 11
- 1/4" internal Torx socket, TX 8, 10, 15, 20, 25, 27, 30, 40
- Angled hex key, long, ball head, 9 pcs. 1.5 – 10 mm
- 1/4 connector for 1/4" bits, A/M 1/4" - 1/4"
- Torx bit assortment with 72 teeth ratchet, 31 pcs.

Item no.	Dimensions in mm (WxD)
08.89.204	400 x 200



**Set of screwdrivers, 10 pcs.**

- Inlet two-coloured black/blue
- Electrician's screwdriver, DIN 5265, carburettor screwdriver 4 x 80 mm, PH1
- Workshop screwdriver, DIN 5265, D, 5 x 100, 5,5 x 125, 6,5 x 150 mm
- Cross-head screwdriver, DIN ISO 8764-1/-2, PH 0, 1, 2
- Voltage tester, VDE 0680, 3 mm

Item no.	Dimensions in mm
08.89.207	400 x 200

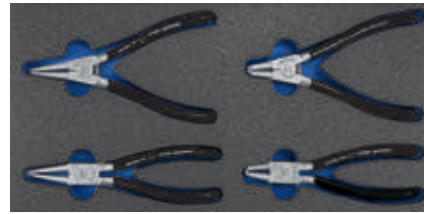
**Set of circlip pliers, 4 pcs.**

- Inlet two-coloured black/blue
- Circlip pliers, DIN 5254, A, A2
- Circlip pliers, DIN 5254, B, A21
- Circlip pliers, DIN 5256, C, J2
- Circlip pliers, DIN 5254, D, J21

Item no.	Dimensions in mm
08.89.208	400 x 200

**Set of pliers, 4 pcs.**

- Inlet two-coloured black/blue
- High leverage combination pliers, DIN ISO 5746, 7" / 180 mm
- High leverage diagonal cutter, DIN ISO 5749, 7" / 180 mm
- Water pump pliers, ISO 8976, B, 240 mm
- Telephone pliers, ISO 5745, straight, 8" / 205 mm

Item no.	Dimensions in mm (WxD)
08.89.209	400 x 200

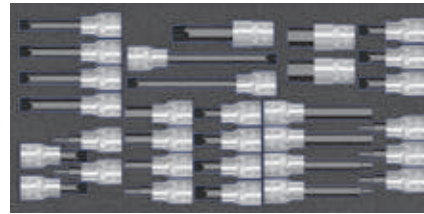
**1/2" hex key Set of socket keys, 31 pcs.**

- Inlet two-coloured black/blue
- 1/2" hex socket, 5 x 60, 5 x 110, 6 x 60, 6 x 110, 7 x 100, 8 x 60, 8 x 110, 10 x 60, 12 x 60, 14 x 60, 17 x 60, 7 x 60 mm
- 1/2" socket B & S / XZN M 5 x 60, 6 x 60, 6 x 100, 8 x 60, 8 x 100, 10 x 60, 10 x 100, 12 x 100 mm; 1/2" internal Torx socket, TX 25 x 60,
- 27 x 60, 30 x 60, 40 x 60, 45 x 60, 50 x 60, 55 x 60, 60 x 60, 45 x 140, 55 x 140, 70 x 110 mm

Item no.	Dimensions in mm (WxD)
08.89.210	400 x 200

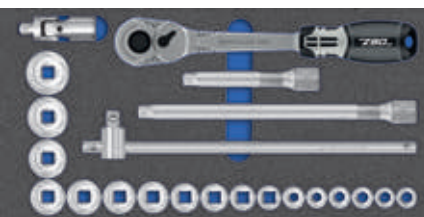
**Set of socket keys 1/2", hex key, 22 pcs.**

- Inlet two-coloured black/blue
- 1/2" reversible ratchet, safety locking 270 mm
- 1/2" sliding T-handle, DIN 3122, 300 mm
- 1/2" cardan joint, 75 mm
- 1/2" extension, swivelling, 125 and 250 mm
- 1/2" hex socket 10, 11, 12, 13, 14, 15, 16, 17, 18, 19, 20, 21, 22, 24, 27, 30, 32 mm

Item no.	Dimensions in mm (WxD)
08.89.205	400 x 200

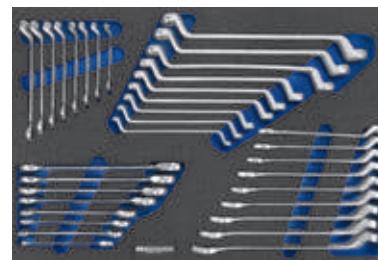
**Set of spanners, 34 pcs.**

- Inlet two-coloured black/blue
- Double open-ended spanner, DIN 3110 6 x 7, 8 x 9, 10 x 11, 12 x 13, 14 x 15, 16 x 17, 18 x 19, 20 x 22, 21 x 23 mm
- Combination spanner, DIN 3113 B 6, 7, 8, 9, 10, 11, 12, 13, 14, 15, 16, 17, 18, 19, 20, 21, 22 mm
- Double-ended ring spanners, DIN 838 6 x 7, 8 x 9, 10 x 11, 12 x 13, 14 x 15, 16 x 17, 18 x 19, 20 x 22, 21 x 23 mm

Item no.	Dimensions in mm (WxD)
08.89.211	600 x 400



Mobile drawer cabinets

T500 mobile drawer cabinets

- Roll-off edge on 3 sides
- 4x steering caster, thereof 2 with locks, Ø 125 mm
- Drawers with full pull-out 100%, load capacity per drawer 50 or 75 kg
- Aluminium handle bars with labelling strip
- Central locking with single pull-out lock
- Double locking of the drawers by means of individual interlocking
- Push handle



Grid subdivision

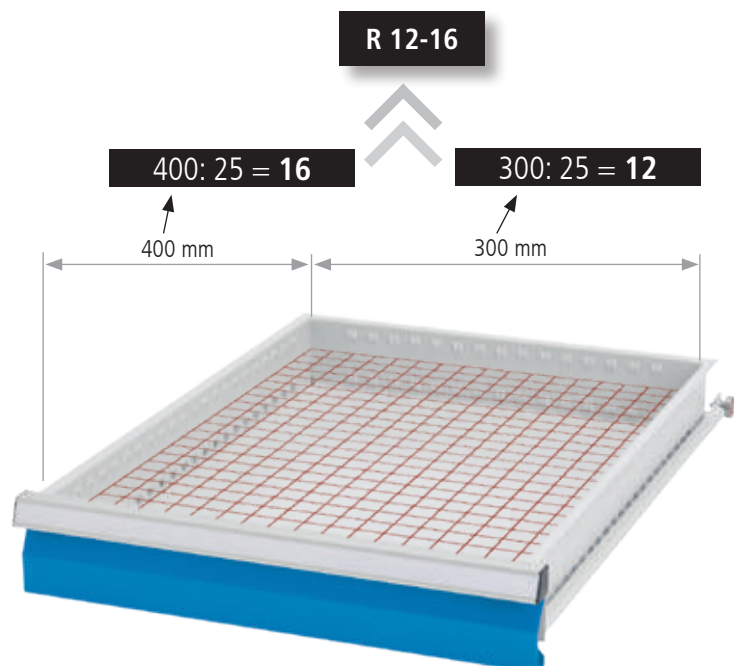

Series	Series	Series
T500	T500	T500



	Housing W x D	Housing W x D	Housing W x D
	530 x 500	680 x 500	980 x 500
Height	Usable heights	Usable heights	Usable heights
519	400	400	–
619	500	500	500
719	600	600	600
819	700	700	700
919	800	800	800
1019	900	900	900
1219	–	–	–
1319	–	1200	1200
1519	–	–	–



		Drawer W x D	Drawer W x D	Drawer W x D
		450 x 400	600 x 400	900 x 400
Height	Shell height	Load capacity	Load capacity	Load capacity
75	59	50 kg	50 kg	50 kg
100	85	50 / 75 kg	50 / 75 kg	50 / 75 kg
150	135	50 / 75 kg	50 / 75 kg	50 / 75 kg
200	185	50 / 75 kg	50 / 75 kg	50 / 75 kg
250	185	50 / 75 kg	50 / 75 kg	50 / 75 kg
300	185	50 / 75 kg	50 / 75 kg	50 / 75 kg



Series	Series	Series
T500	T500	T500
T500 18-16	T500 24-16	T500 36-16

Grid:	R 18-16	R 24-16	R 36-16
--------------	----------------	----------------	----------------



All dimensions in mm

Mobile drawer cabinets

Grid: R 12-14 R 24-12 R 24-16 R 12-16 **R 18-16** R 24-16 R 36-16 R 18-24 R 24-24 R 36-24 R 48-24

Mobile drawer cabinets 530 mm width | 500 mm depth

- Drawer interior dimension 450 x 400 mm
- Drawers with full pull-out (FP) 100 %
- Load capacity per drawer 50 or 75 kg
- Push handle
- Cylinder lock with two keys
- Suitable divider material see page 73

- 4x drawer
- Incl. roll-off edge on 3 sides and ribbed rubber mat
- 4x steering caster, thereof 2 with locks, Ø 125 mm

Item no.	Dimensions in mm (WxDxH)
46.220M	530 x 500 x 800



Individual arrangement

Visit our drawer cabinet configurator at configurator.bedrunka-hirth.de



Housing with Ø 80 mm casters and push handle

- Total height = usable height + 120 mm + 110 mm



Housing with Ø 125 mm casters and push handle

- Total height = usable height + 120 mm + 160 mm



Item no.	Dimensions in mm (WxDxH)	Usable height in mm
01.046M80	530 x 500 x 730	500
01.047M80	530 x 500 x 830	600
01.048M80	530 x 500 x 930	700
01.049M80	530 x 500 x 1030	800
01.040M80	530 x 500 x 1130	900

Item no.	Dimensions in mm (WxDxH)	Usable height in mm
01.046M125	530 x 500 x 780	500
01.047M125	530 x 500 x 880	600
01.048M125	530 x 500 x 980	700
01.049M125	530 x 500 x 1080	800
01.040M125	530 x 500 x 1180	900

Ribbed rubber mat on cabinet

- Oil-proof

Item no.	Dimensions in mm (WxDxH)
65.040.530	530 x 500 x 3

Metal roll-off edge on 3 sides

- 20 mm height

Item no.	Dimensions in mm (WxDxH)
66.046.025	530 x 500 x 20

Cover plate

- Beech multiplex, oiled, 25 mm

Item no.	Dimensions in mm (WxDxH)
67.046.017	530 x 500 x 25

Cover plate

- Melamine resin coated chipboard
- RAL 7035, 16 mm, screwable

Item no.	Dimensions in mm (WxDxH)
67.046.016	530 x 500 x 16

Drawers

- 450 x 400 mm (WxD)

Item no.	Front height in mm	Shell height in mm	Usable height in mm	Load capacity
60.046.075VA	75	59	60	50 kg
60.046.100VA	100	85	90	50 kg
60.046.150VA	150	135	140	50 kg
60.046.200VA	200	185	190	50 kg
60.046.250VA	250	185	240	50 kg
60.046.300VA	300	185	290	50 kg
60.046.100VA-75	100	85	90	75 kg
60.046.150VA-75	150	135	140	75 kg
60.046.200VA-75	200	185	190	75 kg
60.046.250VA-75	250	185	240	75 kg
60.046.300VA-75	300	185	290	75 kg

Divider material see page 51

Mobile drawer cabinets 680 mm width | 500 mm depth

- Drawer interior dimension 600 x 400 mm
- Drawers with full pull-out (FP) 100 %
- Load capacity per drawer 50 or 75 kg
- Push handle
- Cylinder lock with two keys
- Suitable divider material see page 79

- 5x drawer
- Incl. roll-off edge on 3 sides and ribbed rubber mat
- 4x steering caster, thereof 2 with locks, Ø 125 mm

Item no.	Dimensions in mm (WxDxH)
68.221M	680 x 500 x 1000



Individual arrangement

Visit our drawer cabinet configurator at configurator.bedrunka-hirth.de



Housing with Ø 80 mm casters and push handle

- Total height = usable height + 120 mm + 110 mm

Item no.	Dimensions in mm (WxDxH)	Usable height in mm
01.066M80	680 x 500 x 730	500
01.067M80	680 x 500 x 830	600
01.068M80	680 x 500 x 930	700
01.069M80	680 x 500 x 1030	800
01.060M80	680 x 500 x 1130	900



Housing with Ø 125 mm casters and push handle

- Total height = usable height + 120 mm + 160 mm

Item no.	Dimensions in mm (WxDxH)	Usable height in mm
01.066M125	680 x 500 x 780	500
01.067M125	680 x 500 x 880	600
01.068M125	680 x 500 x 980	700
01.069M125	680 x 500 x 1080	800
01.060M125	680 x 500 x 1180	900

Ribbed rubber mat on cabinet

- Oil-proof

Item no.	Dimensions in mm (WxDxH)
65.060.530	680 x 500 x 3

Metal roll-off edge on 3 sides

- 20 mm height

Item no.	Dimensions in mm (WxDxH)
66.068.025	680 x 500 x 20

Cover plate

- Beech multiplex, oiled, 25 mm

Item no.	Dimensions in mm (WxDxH)
67.068.017	680 x 500 x 25

Cover plate

- Melamine resin coated chipboard
- RAL 7035, 16 mm, screwable

Item no.	Dimensions in mm (WxDxH)
67.068.016	680 x 500 x 16

Drawers

- 600 x 400 mm (WxD)

Item no.	Front height in mm	Shell height in mm	Usable height in mm	Load capacity
60.068.075VA	75	59	60	50 kg
60.068.100VA	100	85	90	50 kg
60.068.150VA	150	135	140	50 kg
60.068.200VA	200	185	190	50 kg
60.068.250VA	250	185	240	50 kg
60.068.300VA	300	185	290	50 kg
60.068.100VA-75	100	85	90	75 kg
60.068.150VA-75	150	135	140	75 kg
60.068.200VA-75	200	185	190	75 kg
60.068.250VA-75	250	185	240	75 kg
60.068.300VA-75	300	185	290	75 kg

Divider material see page 57

Mobile drawer cabinets

Grid: R 12-14 R 24-12 R 24-16 R 12-16 R 18-16 R 24-16 **R 36-16** R 18-24 R 24-24 R 36-24 R 48-24

Mobile drawer cabinets 980 mm width | 500 mm depth

- Drawer interior dimension 900 x 400 mm
- Drawers with full pull-out (FP) 100 %
- Load capacity per drawer 50 or 75 kg
- Push handle
- Cylinder lock with two keys
- Suitable divider material see page 85

- 5x drawer
- Incl. roll-off edge on 3 sides and ribbed rubber mat
- 4x steering caster, thereof 2 with locks, Ø 125 mm

Item no.	Dimensions in mm (WxDxH)
98.221M	980 x 500 x 1000



Visit our drawer cabinet configurator at configurator.bedrunka-hirth.de

Individual arrangement



Housing with Ø 80 mm casters and push handle

- Total height = usable height + 120 mm + 100 mm



Item no.	Dimensions in mm (WxDxH)	Usable height in mm
01.096M80	980 x 500 x 730	500
01.097M80	980 x 500 x 830	600
01.098M80	980 x 500 x 930	700
01.099M80	980 x 500 x 1030	800
01.090M80	980 x 500 x 1130	900



Housing with Ø 125 mm casters and push handle

- Total height = usable height + 120 mm + 160 mm



Item no.	Dimensions in mm (WxDxH)	Usable height in mm
01.096M125	980 x 500 x 780	500
01.097M125	980 x 500 x 880	600
01.098M125	980 x 500 x 980	700
01.099M125	980 x 500 x 1080	800
01.090M125	980 x 500 x 1180	900

Ribbed rubber mat on cabinet

- Oil-proof

Item no.	Dimensions in mm (WxDxH)
65.090.530	980 x 500 x 3

Metal roll-off edge on 3 sides

- 20 mm height

Item no.	Dimensions in mm (WxDxH)
66.098.025	980 x 500 x 20

Cover plate

- Beech multiplex, oiled, 25 mm

Item no.	Dimensions in mm (WxDxH)
67.098.017	980 x 500 x 25

Cover plate

- Melamine resin coated chipboard
- RAL 7035, 19 mm, screwable

Item no.	Dimensions in mm (WxDxH)
67.098.016	980 x 500 x 19

Drawers

- 900 x 400 mm (WxD)

Item no.	Front height in mm	Shell height in mm	Usable height in mm	Load capacity
60.098.075VA	75	59	60	50 kg
60.098.100VA	100	85	90	50 kg
60.098.150VA	150	135	140	50 kg
60.098.200VA	200	185	190	50 kg
60.098.250VA	250	185	240	50 kg
60.098.300VA	300	185	290	50 kg
60.098.100VA-75	100	85	90	75 kg
60.098.150VA-75	150	135	140	75 kg
60.098.200VA-75	200	185	190	75 kg
60.098.250VA-75	250	185	240	75 kg
60.098.300VA-75	300	185	290	75 kg

Divider material see page 63

Mobile drawer cabinets | 500 mm depth



- 5x drawer
- 1x perforated wall setup
- Incl. roll-off edge on 3 sides and ribbed rubber mat
- 4x steering caster, thereof 2 with locks, Ø 125 mm

Item no.	Dimensions in mm (WxDxH)	Version
46.500M	530 x 500 x 800	Drawer cabinet
03.983.530	530 x 30 x 605	Perforated wall setup

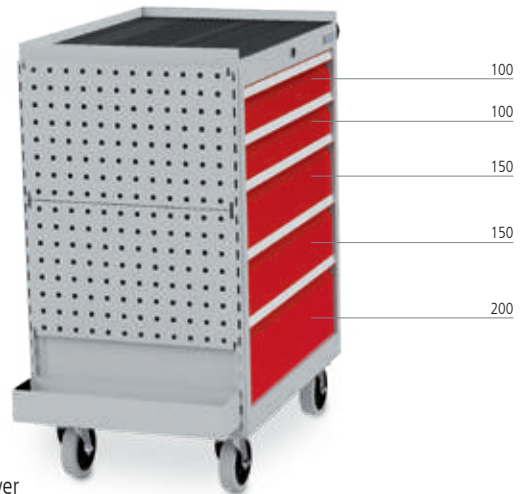

- 5x drawer
- 1x perforated side wall
- 1x depositing box
- Incl. roll-off edge on 3 sides and ribbed rubber mat
- 4x steering caster, thereof 2 with locks, Ø 125 mm

Item no.	Dimensions in mm (WxDxH)	Version
68.221M	680 x 500 x 1000	Drawer cabinet
03.983.680	500 x 819 (WxH)	Perforated side wall

Accessories for perforated wall system



Range of hooks, 10 parts

- 7x tool holder with inclined end
- 2x double tool holder
- 1x tool clamp

Item no.
03.87.395-10



Depositing box

- Dimensions in mm (WxDxH): 500 x 90 x 85
- For hanging into the support columns

Item no.	Version for
03.983.53.1	Perforated wall setup
03.983.736.1	Perforated side wall



Rail for open fronted storage bins

- For hanging on the perforated wall

Item no.	Width in mm
03.900.06	300
03.900.05	450



DIN A4 brochure holder

Item no.	Dimensions in mm (W x H)
03.87.398	220 x 330



Can holder, single

- Width 100 mm

Item no.	Dimensions in mm (Ø)
03.87.369	70



Drill/hex key holder (various dia.)

- 200/390 x 30 x 35, dimensions in mm (W x D x H)

Item no.	Version
03.87.378	for 14 pieces
03.87.379	for 28 pieces

Mobile drawer cabinets

Grid: R 12-14 R 24-12 R 24-16 R 12-16 **R 18-16** R 24-16 R 36-16 R 18-24 R 24-24 R 36-24 R 48-24

Mobile drawer cabinets 1060 mm width | 500 mm depth



- Drawer interior dimension 450 x 400 mm
- With individual interlocking and 2 housing variants
- With full pull-out 100 %, load capacity per drawer 50 kg
- Push handle
- Cylinder lock with two keys
- 4x steering caster, thereof 2 with locks, Ø 125 mm
- Suitable divider material see page 73



- Left: 4x drawer
- Right: 1x hinged door, 1x shelf
- Incl. roll-off edge on 4 sides and ribbed rubber mat

Item no.	Dimensions in mm (WxDxH)
04.11.04	1060 x 500 x 1000

Individual arrangement

Hinged door

- Hinges on the right and left are possible
- Twist lock cylinder lock with 2 keys

Item no.	Usable heights (mm)
01.053.700E	700

Shelf

Item no.	Dimensions in mm (WxDxH)
04.053.013	475 x 443 x 22



Ribbed rubber mat on cabinet

- Oil-proof

Item no.	Dimensions in mm (WxDxH)
65.1060.530	1060 x 500 x 3

Metal roll-off edge on 3 sides

- 20 mm height

Item no.	Dimensions in mm (WxDxH)
04.11.01	1060 x 500 x 20

Cover plate

- Beech multiplex, oiled, 25 mm

Item no.	Dimensions in mm (WxDxH)
67.1060.25	1060 x 500 x 25

Cover plate

- Melamine resin coated chipboard
- RAL 7035, 16 mm, screwable

Item no.	Dimensions in mm (WxDxH)
67.1060.016	1060 x 500 x 25

Mobile drawer cabinet with 2x empty housing, 1x push handle, 4x steering caster Ø 125 mm, usable height 700 mm

Item no.	Dimensions in mm (WxDxH)
04.1100LG	1060 x 500 x 980

Drawers

Divider material see page 51

- 450 x 400 mm (WxD)

Item no.	Front height in mm	Shell height in mm	Usable height in mm	Load capacity
60.046.075VA	75	59	60	50 kg
60.046.100VA	100	85	90	50 kg
60.046.150VA	150	135	140	50 kg
60.046.200VA	200	185	190	50 kg
60.046.250VA	250	185	240	50 kg
60.046.300VA	300	185	290	50 kg
60.046.100VA-75	100	85	90	75 kg
60.046.150VA-75	150	135	140	75 kg
60.046.200VA-75	200	185	190	75 kg
60.046.250VA-75	250	185	240	75 kg
60.046.300VA-75	300	185	290	75 kg

Workshop trolley 1060 mm width | 500 mm depth



- Drawer interior dimension 450 x 400 mm
- Roll-off edge on 4 sides
- **Lockable telescopic roll-off edge with storage space**
- 4x centre compartment rail, top, 1x support surface
- With full pull-out 100 %, load capacity per drawer 50 or 75 kg
- Aluminium handle bar with labelling strip
- Central locking with single pull-out lock
- Double locking of the drawers by means of individual interlocking
- 4x steering caster, thereof 2 with locks, Ø 125 mm
- Suitable divider material see page 73

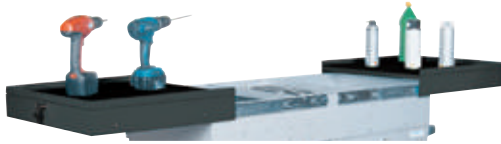

- 4x drawer
- 2x ribbed rubber mat
- 1x shelf
- Incl. perforated side wall

Item no.	Dimensions in mm (WxDxH)
04.116.09	1060 x 500 x 1010

Individual arrangement



Hinged door

- Hinges on the right and left are possible
- Twist lock cylinder lock with 2 keys

Item no.	Usable heights (mm)
01.053.500E	500

Mobile workshop trolley

Empty housing, 1x push handle, 4x steering caster Ø 125 mm, usable height 500 mm incl. perforated wall, shelf and lockable telescopic roll-off edge

Item no.	Dimensions in mm (WxDxH)
04.116LG	1060 x 500 x 1010

Shelf

Item no.	Dimensions in mm (WxDxH)
04.053.013	475 x 443 x 22



Open fronted storage bins

- Polypropylene

Item no.	Dimensions in mm (WxDxH)
03.900.003	145 x 235 / 195 x 125
03.900.004	200 x 350 / 300 x 145
03.900.005	200 x 350 / 300 x 200

Drawers

Divider material see page 51

- 450 x 400 mm (WxD)

Item no.	Front height in mm	Shell height in mm	Usable height in mm	Load capacity
60.046.075VA	75	59	60	50 kg
60.046.100VA	100	85	90	50 kg
60.046.150VA	150	135	140	50 kg
60.046.200VA	200	185	190	50 kg
60.046.250VA	250	185	240	50 kg
60.046.300VA	300	185	290	50 kg
60.046.100VA-75	100	85	90	75 kg
60.046.150VA-75	150	135	140	75 kg
60.046.200VA-75	200	185	190	75 kg
60.046.250VA-75	250	185	240	75 kg
60.046.300VA-75	300	185	290	75 kg

Mobile drawer cabinets

T736 mobile drawer cabinets

- 2x steering caster with locks, 2x fixed caster, Ø 125 mm
- Drawers with full pull-out (FP) 100%
- Drawers with 50 mm front height, load capacity 70 kg
- Drawers from 75 mm front height, load capacity 100 kg
- Aluminium handle bars with labelling strip
- Central locking with single pull-out lock
- Double locking of the drawers by means of individual interlocking
- Plastic push handles
- Roll-off edge on 3 sides



Grid subdivision

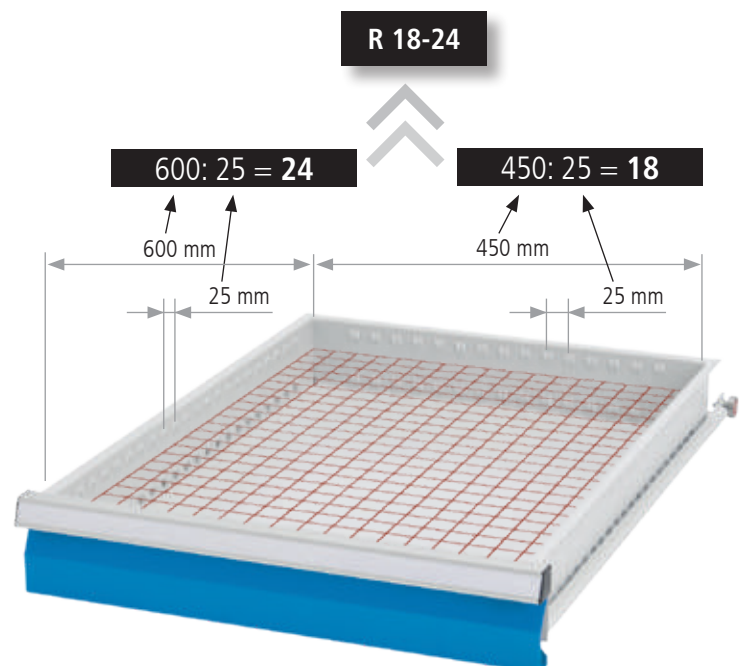

Series	Series	Series
T736	T736	T736



	Housing W x D	Housing W x D	Housing W x D
	555 x 736	705 x 736	1005 x 736
Height	Usable heights	Usable heights	Usable heights
519	400	400	400
619	500	500	500
719	600	600	600
819	700	700	700
919	800	800	800
1019	900	900	900
1219	1100	1100	1100
1319	–	1200	1200
1519	–	1400	1400



		Drawer W x D	Drawer W x D	Drawer W x D
		450 x 600	600 x 600	900 x 600
Height	Shell height	Load capacity	Load capacity	Load capacity
50	28	70 kg	70 kg	70 kg
75	56	100 kg	100 kg	100 kg
100	81	100 kg	100 kg	100 kg
125	81	100 kg	100 kg	100 kg
150	131	100 kg	100 kg	100 kg
175	131	100 kg	100 kg	100 kg
200	181	100 kg	100 kg	100 kg
250	181	100 kg	100 kg	100 kg
300	181	100 kg	100 kg	100 kg
400	81	100 kg	100 kg	100 kg



Series	Series	Series
T736	T736	T736
T736 18-24	T736 24-24	T736 36-24

Grid:	R 18-24	R 24-24	R 36-24
-------	---------	---------	---------



All dimensions in mm

Mobile drawer cabinets

Grid: R 12-14 R 24-12 R 24-16 R 12-16 R 18-16 R 24-16 R 36-16 **R 18-24** R 24-24 R 36-24 R 48-24

555 mm width | 736 mm depth



- Drawer interior dimension 450 x 600 mm
- Drawers with full pull-out 100 %
- Drawers with 50 mm front height, load capacity 70 kg
Drawers from 75 mm front height, load capacity 100 kg
- Aluminium handle bars with labelling strip
- Central locking with single pull-out lock
- Double locking of the drawers by means of individual interlocking
- 2x steering caster with locks, 2x fixed caster, Ø 125 mm
- Suitable divider material see page 97
- Plastic push handle



- 5x drawer
- Incl. roll-off edge on 3 sides and ribbed rubber mat

Item no.	Dimensions in mm (WxDxH)
04.10.05V	555 x 736 x 990

Individual arrangement

Visit our drawer cabinet configurator at configurator.bedrunka-hirth.de



0550M125

Housing with Ø 125 mm casters and push handle

- Total height = usable height + 120 mm + 150 mm

Item no.	Dimensions in mm (WxDxH)	Usable height in mm
0550M125	555 x 736 x 670	400
0560M125	555 x 736 x 770	500
0570M125	555 x 736 x 870	600
0580M125	555 x 736 x 970	700
0590M125	555 x 736 x 1070	800
0500M125	555 x 736 x 1170	900

Ribbed rubber mat on cabinet

- Oil-proof

Item no.	Dimensions in mm (WxDxH)
65.050.730	555 x 736 x 3

Metal roll-off edge on 3 sides

- 20 mm height

Item no.	Dimensions in mm (WxDxH)
66.050.025	555 x 736 x 20

Cover plate

- Beech multiplex, oiled, 25 mm

Item no.	Dimensions in mm (WxDxH)
67.050.017	555 x 736 x 25

Cover plate

- Melamine resin coated chipboard
- RAL 7035, 16 mm, screwable

Item no.	Dimensions in mm (WxDxH)
67.050.016	555 x 736 x 16

Drawers

Divider material see page 75

- 450 x 600 mm (WxD) with full pull-out 100 % – 70/100 kg



Item no.	Front height	Shell height	Usable height	Load capacity
60.50.050V07	50	28	30	70 kg
60.50.075V10	75	56	58	100 kg
60.50.100V10	100	81	83	100 kg
60.50.125V10	125	81	108	100 kg
60.50.150V10	150	131	133	100 kg
60.50.175V10	175	131	158	100 kg
60.50.200V10	200	181	183	100 kg
60.50.250V10	250	181	233	100 kg
60.50.300V10	300	181	283	100 kg

Mobile drawer cabinets 555 mm width | 736 mm depth



100
100
100
100
100
100
100



150
150
200
200

- 7x drawer
- Incl. roll-off edge on 3 sides and ribbed rubber mat
- 1x perforated wall setup

- 4x drawer
- Incl. roll-off edge on 3 sides and ribbed rubber mat
- 1x perforated side wall
- 1x depositing box

Item no.	Dimensions in mm	Version
04.10.07V	555 x 736 x 990	Drawer cabinet
03.983.580	555 x 604	Perforated wall setup

Item no.	Dimensions in mm	Version
04.10.04V	555 x 736 x 990	Drawer cabinet
03.983.581	720 x 604	Perforated side wall

Accessories for perforated wall system



Rail for open fronted storage bins

- For hanging on the perforated wall

Item no.	Width in mm
03.900.06	300
03.900.05	450



Open fronted storage bins

- Polypropylene

Item no.	Dimensions in mm (WxDxH)
03.900.001	100 x 95 / 65 x 50
03.900.002	100 x 175 / 140 x 75
03.900.003	145 x 235 / 195 x 125
03.900.004	200 x 350 / 300 x 145
03.900.005	200 x 350 / 300 x 200



Depositing box

- Dimensions in mm (WxDxH): 730 x 90 x 85
- For hanging into the support columns

Item no.	Version for
03.983.53.1	Perforated wall setup
03.983.736.1	Perforated side wall



Machine holder

Item no.	Dimensions in mm (Ø)
03.87.357	40
03.87.358	60
03.87.359	80



Round holder

Item no.	Dimensions in mm (WxD)
03.87.355	65 x 25



Double tool clamp

Item no.	Dimensions in mm (Ø)
03.87.341	6
03.87.342	10
03.87.343	13
03.87.344	16
03.87.345	19

Mobile workbenches



Mobile workbenches



Mobile workbench with shelves

- Beech multiplex worktop 25 mm
- 4x steering caster, Ø 125 mm, thereof 2 with locks
- Push handle



Item no.	Dimensions in mm (WxDxH)	Designation
04.512.20	1200 x 540 x 880	1x shelf
04.512.30	1200 x 540 x 880	2x shelf

Mobile workbench with shelves

- Beech multiplex worktop 25 mm
- 4x steering caster, Ø 125 mm, thereof 2 with locks
- Push handle



Item no.	Dimensions in mm (WxDxH)	Designation
04.515.20	1500 x 540 x 880	1x shelf
04.515.30	1500 x 540 x 880	2x shelf



Mobile worktable

- Beech multiplex worktop 40 mm
- 1x beech multiplex shelf 25 mm
- 4x steering caster, Ø 125 mm, thereof 2 with locks
- Push handle



Item no.	Dimensions in mm (WxDxH)
04.12.01	1250 x 750 x 859
04.15.01	1500 x 750 x 859
04.20.01	2000 x 750 x 859

Mobile worktable

- Beech multiplex worktop 40 mm
- 1x beech multiplex shelf 25 mm
- 2x fixed and 2x steering caster with locks, Ø 200 mm
- Push handle



Item no.	Dimensions in mm (WxDxH)
04.12.02	1250 x 750 x 995 mm
04.15.02	1500 x 750 x 995 mm
04.20.02	2000 x 750 x 995 mm

Mobile workbenches

Grid: R 12-14 R 24-12 R 24-16 R 12-16 **R 18-16** R 24-16 R 36-16 R 18-24 R 24-24 R 36-24 R 48-24

Mobile workbenches 1200 mm width | 540 mm depth



- Beech multiplex worktop 25 mm
- Drawer interior dimension 450 x 400 mm
- Drawers with full pull-out (FP) 100 %, load capacity 50 or 75 kg
- Cylinder lock with two keys
- Push handle
- 4x steering caster, thereof 2 with locks, Ø 125 mm
- Suitable divider material see page 73



- Left: 2x shelf
- Right: 3x drawer

Item no.	Dimensions in mm (WxDxH)
04.512.03	1200 x 540 x 880



- Left: 2x shelf
- Right: 5x drawer

Item no.	Dimensions in mm (WxDxH)
04.512.05	1200 x 540 x 880

Individual arrangement



Mobile workbench
 1x empty housing, 2x wooden shelf, 1x push handle,
 4x steering caster, thereof 2 with locks, Ø 125 mm, usable height 500 mm

Item no.	Dimensions in mm (WxDxH)
04.512M	1200 x 540 x 880

Drawers

- 450 x 400 mm (WxD)

Item no.	Front height in mm	Shell height in mm	Usable height in mm	Load capacity
60.046.075VA	75	59	60	50 kg
60.046.100VA	100	85	90	50 kg
60.046.150VA	150	135	140	50 kg
60.046.200VA	200	185	190	50 kg
60.046.250VA	250	185	240	50 kg
60.046.300VA	300	185	290	50 kg
60.046.100VA-75	100	85	90	75 kg
60.046.150VA-75	150	135	140	75 kg
60.046.200VA-75	200	185	190	75 kg
60.046.250VA-75	250	185	240	75 kg
60.046.300VA-75	300	185	290	75 kg

Divider material see page 51

Hinged door

- Hinges on the right and left are possible
- Twist lock cylinder lock with 2 keys

Item no.	Usable heights (mm)
01.053.500E	500

Shelf

Item no.	Dimensions in mm (WxDxH)
04.053.013	475 x 443 x 22

Mobile workbenches 1200 mm width | 540 mm depth



- Beech multiplex worktop 25 mm
- Drawer interior dimension 450 x 400 mm
- Drawers with full pull-out (FP) 100 %, load capacity 75 kg
- Cylinder lock with two keys
- Push handle
- 4x steering caster, thereof 2 with locks, Ø 125 mm



- Left: 2x shelf
- Right: 1x hinged door

Item no.	Dimensions in mm (WxDxH)
04.512.01	1200 x 540 x 880

- Left: 2x shelf | Right: 4x drawer

Multi-board setup

- With 2x support column, 1x perforated wall, 1x magnetic board, 1x A4 info pouch

Item no.	Dimensions in mm (WxDxH)
04.512.04	1200 x 540 x 880
03.900.12.02	Multi-board setup 1000 x 650



Multi-board setup

- 2x support column
- 1x perforated wall
- 1x magnetic board
- 2x shelf, 220 mm

Item no.	Dimensions in mm (WxDxH)
03.900.12.01	1000 x 220 x 950

You can find further perforated wall accessories on/from page 236

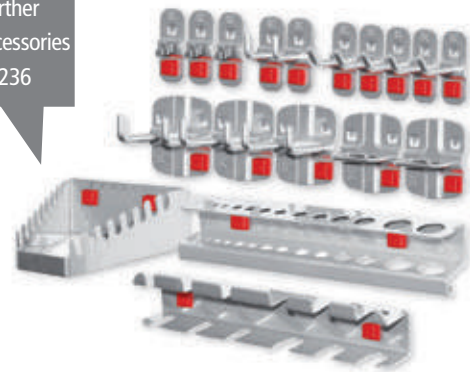

Range of hooks, 18 parts

- 5x tool holder with inclined end
- 2x tool holder with vertical end
- 3x double tool holder
- 3x tool clamp
- 2x pliers holder
- 1x drill holder
- 1x spanner holder
- 1x screwdriver holder

Item no.
03.87.395-18

Mobile workbenches

Grid: R 12-14 R 24-12 R 24-16 R 12-16 R 18-16 R 24-16 R 36-16 **R 18-24** R 24-24 R 36-24 R 48-24

Mobile workbenches 1250 mm width | 750 mm depth



- Beech multiplex worktop 40 mm
- Drawer interior dimension 450 x 600 mm
- Usable height of housing 400 mm
- Cylinder lock with two keys
- Push handle

- Drawers with full pull-out 100 %
- Drawers with 50 mm front height, load capacity 70 kg
- Drawers from 75 mm front height, load capacity 100 kg
- 4x steering caster, Ø 125 mm, thereof 2 with locks
- Suitable divider material see page 97



- Left: 1x hinged door, 1x shelf
- Right: 1x drawer

Item no.	Dimensions in mm (WxDxH)
04.12.04V	1250 x 750 x 859



- Left: 1x hinged door
- Right: 4x drawer

Item no.	Dimensions in mm (WxDxH)
04.12.05V	1250 x 750 x 859

Individual arrangement

4x steering caster, Ø 125 mm, thereof 2 with locks
Usable height 400 mm, 1x push handle



Mobile workbench
1x empty housing, 1x wooden shelf

Item no.	Dimensions in mm (WxDxH)
04.12.859-1M	1250 x 750 x 859



Mobile workbench
2x empty housing

Item no.	Dimensions in mm (WxDxH)
04.12.859-2M	1250 x 750 x 859

Drawers

- 450 x 600 mm (WxD) with full pull-out 100 % – 70/100 kg

Divider material see page 75



Item no.	Front height	Shell height	Usable height	Load capacity
60.50.050V07	50	28	30	70 kg
60.50.075V10	75	56	58	100 kg
60.50.100V10	100	81	83	100 kg
60.50.125V10	125	81	108	100 kg
60.50.150V10	150	131	133	100 kg
60.50.175V10	175	131	158	100 kg
60.50.200V10	200	181	183	100 kg
60.50.250V10	250	181	233	100 kg
60.50.300V10	300	181	283	100 kg

Hinged doors

Item no.	Usable heights (mm)	side
03.050.400EL	400	left
03.050.400ER	400	right

Shelf

Item no.	Dimensions in mm (WxDxH)
03.1094.01	499 x 705 x 20

Mobile workbenches 1250 mm width | 750 mm depth



- Beech multiplex worktop 25 mm
- Drawer interior dimension 450 x 600 mm
- Usable height of housing 600 mm
- Cylinder lock with two keys
- Push handle

- Drawers with full pull-out 100 %
- Drawers with 50 mm front height, load capacity 70 kg
- Drawers from 75 mm front height, load capacity 100 kg
- 4x steering caster, Ø 125 mm, thereof 2 with locks
- Suitable divider material see page 97



- Left: 4x drawer
- Right: 1x hinged door, 1x shelf

Item no.	Dimensions in mm (WxDxH)
04.12.19V	1250 x 750 x 935



- Left: 3x drawer
- Right: 3x drawer

Item no.	Dimensions in mm (WxDxH)
04.12.23V	1250 x 750 x 935

Individual arrangement



Hinged door

- Hinges on the right and left are possible
- Twist lock cylinder lock with 2 keys

Item no.	Usable heights (mm)
03.050.600	600

Shelf

Item no.	Dimensions in mm (WxDxH)
03.1094.01	499 x 705 x 20

Rear edge profile

Item no.	Width in mm
RPA125	1250

Workbench top end profiles on 3 sides

Item no.	Dimensions in mm (WxD)
PA.1275.12	1250 x 750

Mobile workbench

2x empty housing, 1x push handle,
4x steering caster Ø 125 mm, thereof 2 with locks
Usable height 600 mm

Item no.	Dimensions in mm (WxDxH)
04.12.935M	1250 x 750 x 935

Drawers

- 450 x 600 mm (WxD) with full pull-out 100 % – 70/100 kg

Divider material see page 75



Item no.	Front height	Shell height	Usable height	Load capacity
60.50.050V07	50	28	30	70 kg
60.50.075V10	75	56	58	100 kg
60.50.100V10	100	81	83	100 kg
60.50.125V10	125	81	108	100 kg
60.50.150V10	150	131	133	100 kg
60.50.175V10	175	131	158	100 kg
60.50.200V10	200	181	183	100 kg
60.50.250V10	250	181	233	100 kg
60.50.300V10	300	181	283	100 kg

Mobile workbenches

Grid: R 12-14 R 24-12 R 24-16 R 12-16 R 18-16 R 24-16 R 36-16 **R 18-24** R 24-24 R 36-24 R 48-24

Mobile workbenches 1250 mm width | 750 mm depth



- Beech multiplex worktop 40 mm
- Drawer interior dimension 450 x 600 mm
- Usable height of housing 600 mm
- Cylinder lock with two keys
- Push handle

- Drawers with full pull-out 100 %
- Drawers with 50 mm front height, load capacity 70 kg
- Drawers from 75 mm front height, load capacity 100 kg
- 2x fixed and 2x steering caster with locks, Ø 200 mm
- Suitable divider material see page 97



- Left: 4x drawer
- Right: 5x drawer

Item no.	Dimensions in mm (WxDxH)
04.12.29V	1250 x 750 x 995



- Left: 4x drawer
- Right: 4x drawer

Item no.	Dimensions in mm (WxDxH)
04.12.28V	1250 x 750 x 995

Individual arrangement



Hinged door

- Hinges on the right and left are possible
- Twist lock cylinder lock with 2 keys

Item no.	Usable heights (mm)
03.050.600	600

Shelf

Item no.	Dimensions in mm (WxDxH)
03.1094.01	499 x 705 x 20

Rear edge profile

Item no.	Width in mm
RPA125	1250

Workbench top end profiles on 3 sides

Item no.	Dimensions in mm (WxD)
PA.1275.12	1250 x 750

Mobile workbench

2x empty housing, 1x push handle, 2x fixed and 2x steering caster with locks, Ø 200 mm
Usable height 600 mm

Item no.	Dimensions in mm (WxDxH)
04.12.995M	1250 x 750 x 995

Drawers

- 450 x 600 mm (WxD) with full pull-out 100 % – 70/100 kg

Divider material see page 75



Item no.	Front height	Shell height	Usable height	Load capacity
60.50.050V07	50	28	30	70 kg
60.50.075V10	75	56	58	100 kg
60.50.100V10	100	81	83	100 kg
60.50.125V10	125	81	108	100 kg
60.50.150V10	150	131	133	100 kg
60.50.175V10	175	131	158	100 kg
60.50.200V10	200	181	183	100 kg
60.50.250V10	250	181	233	100 kg
60.50.300V10	300	181	283	100 kg

New

Mobile workbenches 1200 mm width | 540 mm depth



- Beech multiplex worktop 25 mm
- Drawer interior dimension 450 x 400 mm
- Drawer guides on ball-bearings

- Drawers with full pull-out 100 %, load capacity 75 kg
- 2 x fixed casters and 2 x steering casters with lock, Ø 200 mm



- Left: 4x drawer
- Right: 4x drawer

Item no.	Dimensions in mm (WxDxH)
04.12.93	1200 x 540 x 820



- Left: 4x drawer
- Right: 2x beech multiplex shelf 25 mm

Item no.	Dimensions in mm (WxDxH)
04.12.91	1200 x 600 x 820



- Left: 1x hinged door
- Right: 2x beech multiplex shelf 25 mm

Item no.	Dimensions in mm (WxDxH)
04.12.90	1200 x 540 x 820



- Left: 4x drawer
- Right: 1x hinged door

Item no.	Dimensions in mm (WxDxH)
04.12.92	1200 x 540 x 820

Drawer inserts, internal dimension 450 x 400 mm



Metal divider | 8 parts

- 2x CCR 400 mm
- 6x DIV 150 mm

Item no.	Front height in mm
146-139-100	100



Metal divider | 15 parts

- 3x CCR 400 mm
- 9x DIV 100 mm
- 3x DIV 150 mm

Item no.	Front height in mm
146-142-100	100



Small parts boxes | 12 parts

- 3x SPB 150 x 150 mm
- 4x SPB 75 x 150 mm
- 4x SPB 75 x 75 mm
- 1x CCR 450 mm

Item no.	Front height in mm
146-132	100

CCR = Centre compartment rails, DIV = Divider, SPB = Small Parts Box, TP = Trough Plate, SDIV = Slot-in divider

Mobile workbenches

Grid: R 12-14 R 24-12 R 24-16 R 12-16 R 18-16 R 24-16 R 36-16 R 18-24 **R 24-24** R 36-24 R 48-24

Mobile workbenches 1500 mm width | 750 mm depth



- Beech multiplex worktop 40 mm
- Drawer interior dimension 600 x 600 mm
- Usable height of housing 400 mm
- Drawers with full pull-out 100 %
- Drawers with 50 mm front height, load capacity 70 kg
- Drawers from 75 mm front height, load capacity 100 kg
- Cylinder lock with two keys
- Push handle
- 4x steering caster, Ø 125 mm, thereof 2 with locks
- Suitable divider material see page 105



- Left: 4x drawer
- Right: 1x drawer 400 mm, load capacity 180 kg

Item no.	Dimensions in mm (WxDxH)
04.15.14V	1500 x 750 x 859



- Left: 4x drawer
- Right: 3x drawer

Item no.	Dimensions in mm (WxDxH)
04.15.43V	1500 x 750 x 859

Individual arrangement



Mobile workbench
2x empty housing, 1x push handle, 4x steering caster Ø 125 mm,
thereof 2 with locks
Usable height 400 mm

Item no.	Dimensions in mm (WxDxH)
04.15.859M	1500 x 750 x 859

Hinged door

- Hinges on the right and left are possible
- Twist lock cylinder lock with 2 keys

Item no.	Usable heights (mm)
03.070.400E	400

Shelf

Item no.	Dimensions in mm (WxDxH)
03.1094.00	649 x 705 x 20

Rear edge profile

Item no.	Width in mm
RPA150	1500

Workbench top end profiles on 3 sides

Item no.	Dimensions in mm (WxD)
PA150	1500 x 750

Divider material see page 83



- 600 x 600 mm (WxD) with full pull-out 100 % – 70/100 kg

Item no.	Front height	Shell height	Usable height	Load capacity
60.70.050V07	50	28	30	70 kg
60.70.075V10	75	56	58	100 kg
60.70.100V10	100	81	83	100 kg
60.70.125V10	125	81	108	100 kg
60.70.150V10	150	131	133	100 kg
60.70.175V10	175	131	158	100 kg
60.70.200V10	200	181	183	100 kg
60.70.250V10	250	181	233	100 kg
60.70.300V10	300	181	283	100 kg

- Beech multiplex worktop 40 mm
- Drawer interior dimension 600 x 600 mm
- Usable height of housing 400 mm
- Drawers with full pull-out 100 %, load capacity 100 kg
- Push handle
- 4x steering caster, Ø 125 mm, thereof 2 with locks



- Left: 4x drawer
- Right: 1x hinged door

Item no.	Dimensions in mm (WxDxH)
04.15.41V	1500 x 750 x 859



- Left: 1x drawer, 1x hinged door
- Right: 1x drawer, 1x hinged door

Multi-board

- 2x support column
- 1x shelf, 220 mm, 1x perforated wall, 1x magnetic board

Item no.	Dimensions in mm (WxDxH)	Version
04.15.22V	1500 x 750 x 859	Mobile workbench
03.900.15.32	1500 x 1250	Multi-board



- Left: 3x drawer
- Right: 3x drawer

Multi-board

- 2x support column, 1x overhead frame, 1x equipment rail
- 1x perforated wall, 1x magnetic board, 1x shelf, 320 mm

Item no.	Dimensions in mm	Version
04.15.33V	1500 x 750 x 859	Mobile workbench
03.900.15.30	1500 x 1250	Multi-board



- Left: 1x hinged door
- Right: 4x drawer

Multi-board

- 2x support column
- 1x magnetic board, 1x shelf, 220 mm, 1x shelf, 320 mm

Item no.	Dimensions in mm	Version
04.15.24V	1500 x 750 x 859	Mobile workbench
03.900.15.31	1500 x 1250	Multi-board

Supplied without hooks, boxes and decoration

Mobile computer, measuring and testing stations

Besides standard products in various widths and heights with extensive accessory parts, we also manufacture customer-related solutions and tailor-made products for your production and/or storage area. Simply ask us!



Media stand

- Plastic roller shutters, lockable, top
- Perforated double hinged door, lockable, bottom
- 1x shelf
- Cable passage in rear wall
- 4x steering caster Ø125, thereof 2 with locks
- 2x push handle

Item no.	Dimensions in mm (WxDxH)
04.RC.01	1250 x 500 x 1757



Coffee stand with lateral folding table

- Plastic roller shutters, lockable, top
- 1x hinged door
- 2x shelf
- Lateral folding table, beech multiplex 25 mm
- Cable passage in rear wall
- 4x steering caster Ø125, thereof 2 with locks
- 2x push handle

Item no.	Dimensions in mm (WxDxH)
04.RC.02	600/1400 x 700 x 1757

All models are intended for the holding of IT hardware components. Equipped to customer requirements.

Advantages

- All models are available in stationary and mobile versions
- Stable sheet steel constructions with a powder coating
- Cable passages on the rear
- Ventilation slots/square holes
- Individually configured or according to our arrangement
- Supplied fully assembled

Computer cabinet

Mobile add-on:

- 2x fixed and 2x steering caster with locks, Ø 125 mm

Computer cabinet:

- Hinged door: top H 727, bottom H 979 mm
- Keyboard drawer: H 84 mm with anti-slip mat
- Pull-out shelf
- Fan
- Socket bar, 4x with connection cable

Item no.	Dimensions in mm (WxDxH)	Description
04.118.601	680 x 600 x 160	Mobile add-on
04.118.05	680 x 736 x 160	Mobile add-on
04.118.600	680 x 600 x 1838	Computer cabinet
04.118.003	680 x 736 x 1838	Computer cabinet

Visible area:
468 x 561 mm (W x D)
used for 21" monitor



Computer cabinet | Stationary

- Hinged door: top H 558, bottom H 630 mm
- Keyboard drawer: H 84 mm
- Fan
- 1x 4-way socket bar with connection cable

Item no.	Dimensions in mm (WxDxH)
04.118.002	680 x 736 x 1320



Computer cabinet | Stationary or mobile

- Computer housing made of high-quality thin sheet metal with one vertical and one horizontal partition wall and 1 x keyboard drawer
- 1x 4-way socket bar
- Monitor attachment housing incl. keyboard drawer
- Mobile add-on: 2x fixed and 2x steering caster with locks, Ø 125 mm

Item no.	Dimensions in mm (WxDxH)	Description
04.118.609	1005 x 600 x 160	Mobile add-on: 2x fixed and 2x steering caster with locks, Ø 125 mm
04.118.608	1005 x 600 x 820	Computer housing
04.118.607	680 x 600 x 820	Monitor attachment housing

Mobile computer, measuring and testing stations

Mobile office | Stationary or mobile

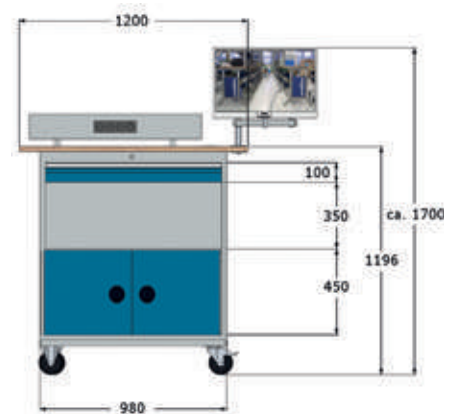

Mobile office 1 | Stationary or mobile

- Computer cabinet with 1x shelf
- 2x hinged door
- 1x drawer, 100 mm
- Energy duct with 4x earthed sockets and monitor bracket
- Square holes in rear wall for ventilation

Pos.	Item no.	Dimensions in mm (WxDxH)	Description
1	01.098.009	980 x 500 x 150	Mobile add-on: - 4x steering caster, thereof 2 with locks, Ø 125 mm
2	04.980.30	463 x 211	Tray
3	04.980.02	980 x 500 x 1020	Housing with hinged doors
4	60.098.100VA	900 x 400 x 100	Drawer FH 100 mm
5	03.12.25	1200 x 600 x 25	Beech multiplex worktop 25mm
6	07.861.10.14	1000 x 60 x 130	Energy duct with 1x 4-way socket
7	07.98.20	333 x 320	Monitor bracket complete with pivot arm
	04.980.01	1200 x 600 x 1196	Mobile office, as illustrated

Computer trolley | Stationary or mobile

Mobile logistics systems

- Stationary or mobile
- Cable passages
- Square holes in rear wall for ventilation



- 1x shelf
- Beech multiplex top 25 mm
- 2x hinged door
- 1x drawer, 100 mm
- 1x monitor attachment housing
- Window cutout, 355 x 550 mm
- 1x roller base, Ø 125 mm

- 2x hinged door
- 1x keyboard pull-out
- 1x shelf
- Perforated rear wall
- 1x inclined shelf
- 1x flat screen bracket with VESA screw connection
- 1x roller base, Ø 125 mm
- 1x 4-way socket

Pos.	Item no.	Dimensions in mm (WxDxH)	Description
1	01.098.009	980 x 500 x 150	Mobile add-on: 4x steering caster, thereof 2 with locks, Ø 125 mm
2	04.980.03	980 x 500 x 1044	Housing with hinged doors and worktop
3	04.110.CM	700 x 300 x 600	Monitor attachment housing
	04.980.04	1200 x 700 x 1796	Computer trolley, as illustrated

Pos.	Item no.	Dimensions in mm (WxDxH)	Description
1	01.068.009	680 x 500 x 150	Mobile add-on: 4x steering caster, thereof 2 with locks, Ø 125 mm
2	04.680.01	680 x 500 x 820	Housing with hinged doors
3	04.680.PA	680 x 500 x 640	Perforated wall with flat screen bracket + desk attachment and pull-out drawer
	04.680.C125	680 x 500 x 1610	Computer trolley, as illustrated



- 1x hinged door
- Beech multiplex top 25 mm
- 1x drawer, 100 mm
- 1x roller base, Ø 125 mm
- 1x 4-way socket

- 2x hinged door
- Beech multiplex top 25 mm
- 1x monitor attachment housing
- Window cutout, 355 x 550 mm
- 1x roller base, Ø 125 mm
- 1x 4-way socket

Pos.	Item no.	Dimensions in mm (WxDxH)	Description
1	01.046.009	530 x 500 x 150	Mobile add-on: 4x steering caster, Ø 125 mm, thereof 2 with locks
2	04.530.01	530 x 500 x 820	Housing with hinged door, 1x shelf, 1x socket bar and 1x drawer
3	03.53/50.25	530 x 500 x 25	Beech multiplex top 25 mm
	04.530.02	530 x 500 x 1000	Computer trolley, as illustrated

Pos.	Item no.	Dimensions in mm (WxDxH)	Description
1	01.068.009	680 x 500 x 150	Mobile add-on: 4x steering caster, Ø 125 mm, thereof 2 with locks
2	04.680.10	700 x 500 x 820	Housing with hinged doors, top and 1x shelf
3	04.110.CM	700 x 300 x 600	Monitor attachment housing
	04.680.02	750 x 500 x 1600	Computer trolley, as illustrated

Mobile computer, measuring and testing stations

Computer trolley 105 | Stationary or mobile

- Hinged door cabinet with or without desk attachment
- Attachment parts such as perforated walls and monitor brackets with VESA screw connection can be retrofitted.
- Stationary or mobile
- Cable passages
- Square holes in rear wall for ventilation



Computer trolley 105-1

- 1x hinged door
- 1x drawer
- 2x shelf
- 1x monitor bracket with VESA screw connection
- 1x mouse tray
- 1x roller base, Ø 125 mm
- 1x 4-way socket

Pos.	Item no.	Dimensions in mm (WxDxH)	Description
1	04.105.125	500 x 500 x 150	Mobile add-on: 4x steering caster, Ø 125 mm, thereof 2 with locks
2	04.105C	500 x 500 x 1000	Hinged door cabinet
3	04.105.BH	500 x 575	Flat screen attachment
4	04.105.MAA	150 x 175	Mouse tray
	04.105.MC125	500 x 500 x 1725	Computer trolley, as illustrated



Computer trolley 105-2

- 1x hinged door
- 1x drawer
- 2x shelf
- 1x desk attachment
- 1x monitor bracket with VESA screw connection
- 1x mouse tray
- 1x roller base, Ø 125 mm
- 1x 4-way socket

Pos.	Item no.	Dimensions in mm (WxDxH)	Description
1	04.105.125	500 x 500 x 150	Mobile add-on: 4x steering caster, Ø 125 mm, thereof 2 with locks
2	04.105C	500 x 500 x 1000	Hinged door cabinet
3	04.105.205	500 x 500 x 250	Desk attachment
4	04.105.BH	500 x 575	Flat screen attachment
5	04.105.MAA	150 x 175	Mouse tray
	04.105.MKC125	500 x 500 x 1725	Computer trolley, as illustrated

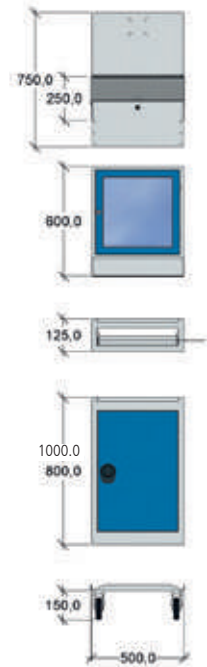



Computer trolley 105-3

- 1x hinged door
- 1x drawer
- 2x shelf
- 1x monitor attachment housing
- 1x mouse tray
- 1x roller base, Ø 125 mm
- 1x 4-way socket

Pos.	Item no.	Dimensions in mm (WxDxH)	Description
1	04.105.125	500 x 500 x 150	Mobile add-on: 4x steering caster, Ø 125 mm, thereof 2 with locks
2	04.105C	500 x 500 x 1000	Hinged door cabinet
3	04.105.CM01	500 x 300 x 600	Monitor attachment housing
4	04.105.MAA	150 x 175	Mouse tray
	04.105.C01	500 x 500 x 1750	Computer trolley, as illustrated

Computer trolley 105-4

- 1x hinged door
- 1x drawer
- 2x shelf
- 1x intermediate block with keyboard pull-out
- 1x monitor attachment housing
- 1x mouse tray
- 1x roller base, Ø 125 mm
- 1x 4-way socket

Pos.	Item no.	Dimensions in mm (WxDxH)	Description
1	04.105.125	500 x 500 x 150	Mobile add-on: 4x steering caster, Ø 125 mm, thereof 2 with locks
2	04.105C	500 x 500 x 1000	Hinged door cabinet
3	04.105.TAA	500 x 500 x 125	1x intermediate block with keyboard pull-out
4	04.105.CM02	500 x 500 x 600	Monitor attachment housing
5	04.105.MAA	150 x 175	Mouse tray
	04.105.C02	500 x 500 x 1950	Computer trolley, as illustrated

Mobile computer, measuring and testing stations

Computer trolley 110 | Stationary or mobile

- Stationary or mobile
- Cable passages
- Square holes in rear wall for ventilation



Computer trolley 110-1

- 2x hinged door
- 1x adjustable shelf
- 1x monitor attachment housing
- 1x roller base, Ø 125 mm

Pos.	Item no.	Dimensions in mm (WxDxH)	Description
1	04.110.125	1000 x 500 x 150	Mobile add-on: 4x steering caster, Ø 125 mm, thereof 2 with locks
2	04.180.C01	1000 x 500 x 820	Hinged door cabinet
3	04.105.CM01	500 x 300 x 600	Monitor attachment housing
	04.180.C03	1000 x 500 x 1575	Computer trolley, as illustrated



Computer trolley 110-2

- 2x hinged door
- 1x adjustable shelf
- 1x monitor attachment housing
- 1x roller base, Ø 125 mm

Pos.	Item no.	Dimensions in mm (WxDxH)	Description
1	04.110.125	1000 x 500 x 150	Mobile add-on: 4x steering caster, Ø 125 mm, thereof 2 with locks
2	04.180.C01	1000 x 500 x 820	Hinged door cabinet
3	04.110.CM	700 x 300 x 600	Monitor attachment housing
	04.180.C04	1000 x 500 x 1575	Computer trolley, as illustrated

Computer trolley 110-3

- 2x hinged door
- 1x adjustable shelf
- 1x monitor attachment housing
- 1x roller base, Ø 125 mm

Pos.	Item no.	Dimensions in mm (WxDxH)	Description
1	04.110.125	1000 x 500 x 150	Mobile add-on: 4x steering caster, Ø 125 mm, thereof 2 with locks
2	04.180.C01	1000 x 500 x 820	Hinged door cabinet
3	04.MAG100/30	1000 x 300 x 600	Monitor attachment housing, two-door
	04.180.C05	1000 x 500 x 1575	Computer trolley, as illustrated



Visible area:
345 x 355 mm (W x D)
used for 15,6" monitor

Computer trolley 110-4

- 2x hinged door
- 1x adjustable shelf
- 1x monitor attachment housing
- 1x roller base, Ø 125 mm
- 1x desk attachment

Pos.	Item no.	Dimensions in mm (WxDxH)	Description
1	04.110.125	1000 x 500 x 150	Mobile add-on: 4x steering caster, Ø 125 mm, thereof 2 with locks
2	04.180.C01	1000 x 500 x 820	Hinged door cabinet
3	04.105.205	500 x 500 x 250	Desk attachment
4	04.105.CM01	500 x 300 x 600	Monitor attachment housing
5	04.105.MAA	150 x 175	Mouse tray
	04.180.C06	1000 x 500 x 1575	Computer trolley, as illustrated



Computer trolley 110-5

- 2x hinged door
- 1x adjustable shelf
- 1x roller base, Ø 125 mm
- 1x desk attachment with pull-out drawer and perforated wall

Pos.	Item no.	Dimensions in mm (WxDxH)	Description
1	04.110.125	1000 x 500 x 150	Mobile add-on: 4x steering caster, Ø 125 mm, thereof 2 with locks
2	04.180.C01	1000 x 500 x 820	Hinged door cabinet
3	04.680.PA	680 x 500 x 640	Perforated wall with flat screen bracket + desk attachment and pull-out drawer
	04.180.C02	1000 x 500 x 1610	Computer trolley, as illustrated



Visible area:
550 x 355 mm (W x D)
used for 24" monitor

Computer trolley 110-6

- 2x hinged door
- 1x adjustable shelf
- 1x monitor attachment housing
- 1x roller base, Ø 125 mm

Pos.	Item no.	Dimensions in mm (WxDxH)	Description
1	04.110.125	1000 x 500 x 150	Mobile add-on: 4x steering caster, Ø 125 mm, thereof 2 with locks
2	04.180.C01	1000 x 500 x 820	Hinged door cabinet
3	03.12/60.25	1200 x 600 x 25	Wooden shelf
4	04.110.CM	700 x 300 x 600	Monitor attachment housing
	04.180.C07	1200 x 600 x 1660	Computer trolley, as illustrated

Parts trolley

Multi-trolley combinations from practice

- Total load capacity 500 kg
- Side push handle
- Equipped with 2x fixed and 2x steering caster with locks, Ø 125 mm

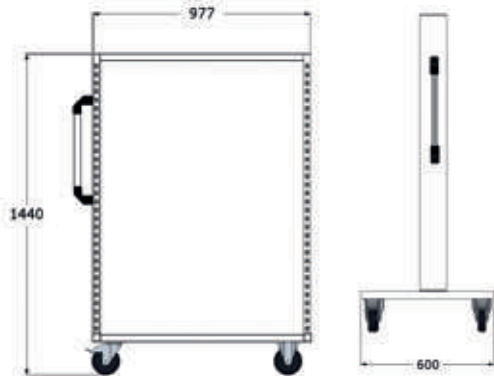

Multi-trolley

- Empty

Item no.	Dimensions in mm (WxDxH)
07.58.10	990 x 610 x 1450

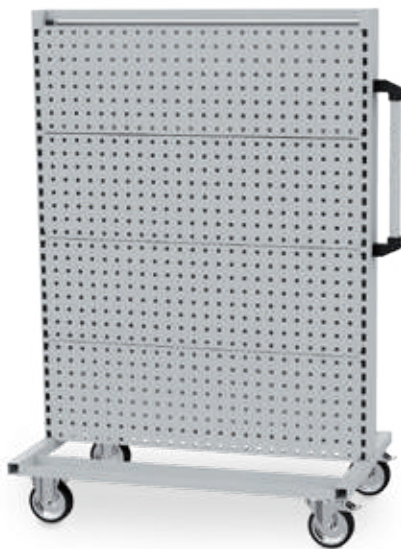

Multi-trolley

- 8x perforated wall, 302 mm

Item no.	Dimensions in mm (WxDxH)
07.58.17	990 x 610 x 1450



Multi-trolley

- Bottom shelf
- 8x inclinable shelf 320 mm depth
- Supplied without decoration

Item no.	Dimensions in mm (WxDxH)
07.58.14	990 x 610 x 1450

Accessories



Bin carrier 1000 mm

- Fully equipped with open fronted storage bins

Item no.	Open fronted storage bins in mm	Piece
03.900.012	Size 2: 100 x 170 / 140 x 80	8
03.900.013	Size 3: 145 x 230 / 195 x 125	6
03.900.015	Size 5: 200 x 350 / 300 x 200	4



Bottom shelf

- For multi-trolley 07.58.10

Item no.
07.58.20

Top shelf

- For multi-trolley 07.58.10

Item no.
07.58.22



Multi-trolley

- Bottom shelf
- 4x inclinable shelf 320 mm depth
- 2x perforated wall, 302 mm
- Supplied without decoration

Item no.	Dimensions in mm (WxDxH)
07.58.16	990 x 610 x 1450



Multi-trolley

- 2x shelf, 220 mm depth
- 2x inclinable shelf, 320 mm
- 1x multi-roller shutter cabinet

Item no.	Dimensions in mm (WxDxH)
07.58.19	990 x 610 x 1450



Multi-trolley

- Complete, as illustrated
- 4x bin strip with open fronted storage bins, size 2
- 4x bin strip with open fronted storage bins, size 3
- 4x bin strip with open fronted storage bins, size 5

Item no.	Dimensions in mm (WxDxH)
07.58.12	990 x 610 x 1450



Multi-trolley

- Top shelf
- 4x inclinable shelf 420 mm depth
- 8x Euro storage bin 400 x 600 x 120 mm

Item no.	Dimensions in mm (WxDxH)
07.58.18	990 x 610 x 1450

Accessories



Euro storage bin

- Polypropylene
- Blue

Item no.	Dimensions in mm (WxDxH)
03.55498	300 x 400 x 120
03.55501	300 x 400 x 170
03.55504	300 x 400 x 220



Shelf

- 0°, 10° & 20° inclinable

Item no.	Depth in mm
03.910.220	220
03.910.320	320
03.910.420	420

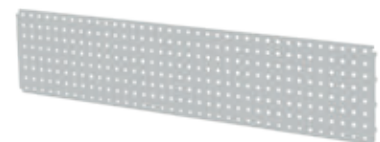

Perforated wall

- Mounting between support columns

Item no.	Dimensions in mm (WxDxH)
03.983.102	1000 x 20 x 302

Parts trolley

Multi-trolley combinations from practice - conductive

These mobile material and small parts storage units are ideal wherever assembly, repairs or commissioning is carried out. Fitted with slotted panels and assorted practical open fronted storage bins on both sides, they keep all types of small material clearly arranged and ready to hand and ensure easy transport.

- Small parts boxes L x W x H Size 6 = 230 x 140 x 130 mm | Size 7 = 160 x 105 x 75 mm | Size 8 = 85 x 105 x 45 mm
- Modular structure, 3 different heights, impact and scratch resistant plastic coating, width 1000 mm, depth 500 mm
- Double-sided use, ergonomic handles, horizontal mounting and dismantling of open fronted storage bins



The special design of the hanging rail allows to hang and unhang the storage bin absolutely horizontally even when they're filled. So no spilling of the stored goods.



Trolley - Size 2

- W x D x H: 1000 x 500 x 890 mm
- with 88 Bins

Item no.	Size 6	Size 7	Size 8
04.01.0913	24	64	-



Trolley - Size 2

- W x D x H: 1000 x 500 x 890 mm
- with 96 Bins

Item no.	Size 6	Size 7	Size 8
04.02.0913	-	96	-



Trolley - Size 2

- W x D x H: 1000 x 500 x 890 mm
- with 60 Bins

Item no.	Size 6	Size 7	Size 8
04.03.0913	60	-	-



Trolley - Size 3

- W x D x H: 1000 x 500 x 1230 mm
- with 152 Bins

Item no.	Size 6	Size 7	Size 8
04.01.2013	24	80	48



Trolley - Size 3

- W x D x H: 1000 x 500 x 1230 mm
- with 112 Bins

Item no.	Size 6	Size 7	Size 8
04.02.2013	48	64	-



Trolley - Size 3

- W x D x H: 1000 x 500 x 1230 mm
- with 84 Bins

Item no.	Size 6	Size 7	Size 8
04.03.2013	84	-	-

Colours

RAL 5010	RAL 7016	RAL 7035
----------	----------	----------

506



Fitting trolleys also ESD conductive available on page 452

New

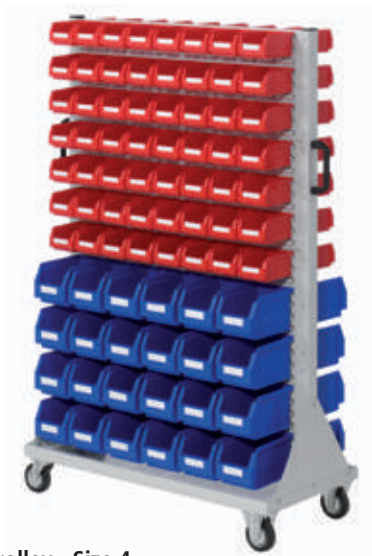

Trolley - Size 4
 ■ W x D x H: 1000 x 500 x 1580 mm
 ■ with 160 Bins

Item no.	Size 6	Size 7	Size 8
04.01.3513	48	112	-



Trolley - Size 4
 ■ W x D x H: 1000 x 500 x 1580 mm
 ■ with 192 Bins

Item no.	Size 6	Size 7	Size 8
04.02.3513	-	192	-



Trolley - Size 4
 ■ W x D x H: 1000 x 500 x 1580 mm
 ■ with 108 Bins

Item no.	Size 6	Size 7	Size 8
04.03.3513	108	-	-

New

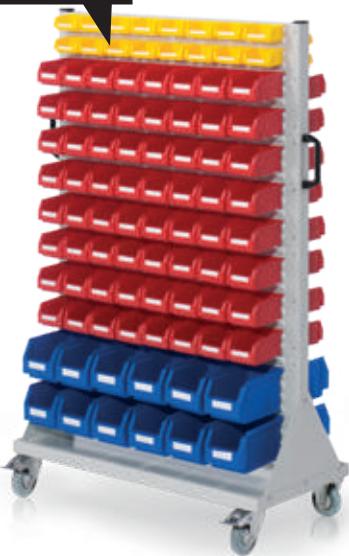

Trolley - Size 4
 ■ W x D x H: 1000 x 500 x 1580 mm
 ■ with 184 Bins

Item no.	Size 6	Size 7	Size 8
04.04.3513	24	128	32

Colours

RAL 5010	RAL 7016	RAL 7035
----------	----------	----------

New

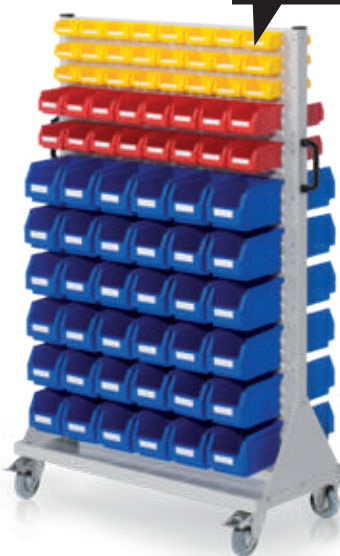

Trolley - Size 4
 ■ W x D x H: 1000 x 500 x 1580 mm
 ■ with 152 Bins

Item no.	Size 6	Size 7	Size 8
04.05.3513	72	32	48



Trolley - Size 4
 ■ W x D x H: 1000 x 500 x 1580 mm
 ■ with 176 Bins

Item no.	Size 6	Size 7	Size 8
04.06.3513	48	80	48



Parts trolley

RasterMobil® - Combinations from practice

RasterMobil®

is the practical rolling material and tool store - your useful helper in the workshop, factory and assembly hall. They are particularly helpful to save time. Work processes can be organised organised from any location.

- Modular construction in three heights
- Subsequent modification and/or exchange of panels possible
- Impact- and scratch-resistant plastic coating
- Fahrmodul lichtgrau
- Double-sided perforated/slotted panels
- Ergonomische Handgriffe
- Ergonomic handles
- 2 x fixed and 2 x steering castors with lock Ø 100 mm



Open fronted storage bins for hanging

New



RasterMobil® Trolley - Size 2

- W x D x H: 1000 x 500 x 890 mm
- 1 x base shelf made of sheet steel
- 1 x range of hooks 10 pcs.
- With 11 Bins

Item no.	Size 6	Size 7	Size 8
04.47.1016	6	5	-

RasterMobil® Trolley - Size 2

- W x D x H: 1000 x 500 x 890 mm
- 1 x base shelf made of sheet steel
- Incl. ribbed rubber mat
- 1 x range of hooks 10 pcs.
- With 12 Bins

Item no.	Size 6	Size 7	Size 8
04.42.1016	-	8	4



RasterMobil® Trolley - Size 2

- W x D x H: 1000 x 500 x 890 mm
- 1 x base shelf made of sheet steel
- Top: beech mutliplex 30 mm
- 1 x range of hooks 10 pcs.
- With 14 Bins

Item no.	Size 6	Size 7	Size 8
04.43.1016	6	4	4

RasterMobil® Trolley - Size 3

- W x D x H: 1000 x 500 x 1230 mm
- 1 x base shelf made of sheet steel
- Incl. ribbed rubber mat
- 1 x range of hooks 15 pcs.
- 1 x document holder A4
- With 14 Bins

Item no.	Size 6	Size 7	Size 8
04.47.2216	6	8	-

RasterMobil® Trolley - Size 3

- W x D x H: 1000 x 500 x 1230 mm
- 1 x base shelf made of sheet steel
- 1 x range of hooks 15 pcs.
- With 10 Bins

Item no.	Size 6	Size 7	Size 8
04.43.2216	6	4	-

Colours

RAL 5010	RAL 7016	RAL 7035

508

New

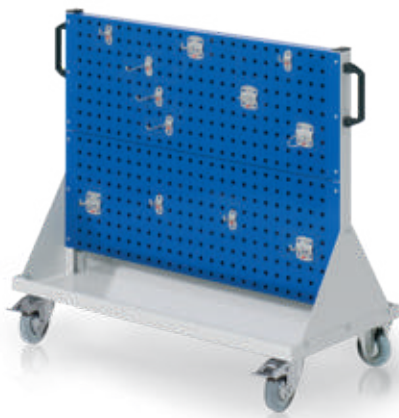

RasterMobil® Trolley - Size 2

- W x D x H: 1000 x 500 x 890 mm
- 1 x range of hooks 12 pcs.

Item no.	Size 6	Size 7	Size 8
04.46.0813	-	-	-

RasterMobil® Trolley - Size 2

- W x D x H: 1000 x 500 x 890 mm
- 1 x range of hooks 10 pcs.
- With 12 Bins

Item no.	Size 6	Size 7	Size 8
04.41.1016	-	8	4

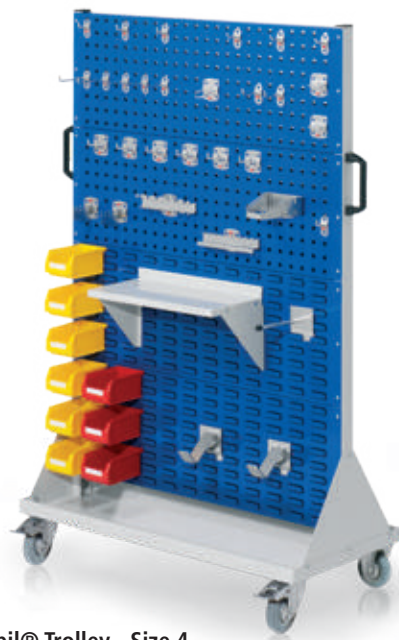

RasterMobil® Trolley - Size 4

- W x D x H: 1000 x 500 x 1580 mm
- 1 x range of hooks 18 pcs.
- 1 x shelf 950 mm
- 1 x hook, fork holder
- 2 x hook, shaft carrier
- With 9 Bins

Item no.	Size 6	Size 7	Size 8
04.41.4116	2	-	7

RasterMobil® Trolley - Size 4

- W x D x H: 1000 x 500 x 1580 mm
- 1 x range of hooks 28 pcs.
- 1 x shelf 450 mm
- 1 x hook, universal holder
- 2 x hook, mandrel carrier
- With 9 Bins

Item no.	Size 6	Size 7	Size 8
04.41.3916	--	9	-

Colours

RAL 5010	RAL 7016	RAL 7035
----------	----------	----------



Other mobile units

Hinged door cabinet



Hinged door cabinet, type 105, mobile

- 2x adjustable shelf
- 1x drawer with full pull-out 100 %, load capacity 50 kg
- 1x roller base, Ø 125 mm

Item no.	Dimensions in mm (WxDxH)
04.105MK125	500 x 500 x 1400 with desk attachment
04.105M125	500 x 500 x 1150 without desk attachment



Hinged door cabinet, type 105

- 1x drawer with full pull-out 100 %, load capacity 50 kg
- 2x shelf
- 1x roll-off edge

Item no.	Dimensions in mm (WxDxH)
04.105	500 x 500 x 1000

Individual components



Roller base

- 4x steering caster, Ø 50 mm
- Thereof 2 with locks



Item no.	Dimensions in mm (WxDxH)
04.105.50	500 x 500 x 65



Roller base

- 4x steering caster, Ø 125 mm
- Thereof 2 with locks



Item no.	Dimensions in mm (WxDxH)
04.105.125	500 x 500 x 150



Desk attachment

- With tray and cylinder lock

Item no.	Dimensions in mm (WxDxH)
04.105.205	500 x 500 x 250



Hinged door cabinet, type 110

- 1x roller base, Ø 125 mm
- 2x drawer with full pull-out 100 %, load capacity 50 kg
- 2x shelf
- 1x roll-off edge

Item no.	Dimensions in mm (WxDxH)
04.110M125	1000 x 500 x 1150

Hinged door cabinet, type 110

- 2x drawer with full pull-out 100 %, load capacity 50 kg
- 2x shelf
- 1x roll-off edge

Item no.	Dimensions in mm (WxDxH)
04.110	1000 x 500 x 1000

Roller base

- 4x steering caster, Ø 125 mm
- Thereof 2 with locks



Item no.	Dimensions in mm (WxDxH)
04.110.125	1000 x 500 x 150



WAF – Work assembly frame

Mobile logistics systems



- Load capacity 30 kg each
- Delivered unassembled!



- Stepless height adjustment
- Caster types: Ø50 mm: 4 x plastic steering caster
Ø100 mm: 4 x steering caster with locks
- Tray 610 x 410 mm (W x D) with Ripped rubber mat

Item no.	Dimensions in mm (WxDxH)	Caster dia. in mm
05.10.20	660 x 660 x 872 – 1222	50
05.10.21	660 x 660 x 945 – 1295	100



- Stepless height adjustment
- Up to 30° inclinable
- Caster types: Ø50 mm: 4 x plastic steering caster
Ø100 mm: 4 x steering caster with locks
- Tray 610 x 410 mm (W x D) with Ripped rubber mat

Item no.	Dimensions in mm (WxDxH)	Caster dia. in mm
05.10.30	660 x 660 x 921 – 1271	50
05.10.31	660 x 660 x 994 – 1344	100



- Stepless height adjustment
- Up to 30° inclinable
- 4x steering caster with locks
- Tray 610 x 410 mm (W x D) with Ripped rubber mat

Item no.	Dimensions in mm (WxDxH)	Caster dia. in mm
05.10.51	600 x 600 x 1024 – 1374	100



- Stepless height adjustment
- Up to 30° inclinable
- Equipped with 4x adjustable feet
- Tray 610 x 410 mm (W x D) with Ripped rubber mat

Item no.	Dimensions in mm (WxDxH)
05.10.52	600 x 600 x 900 – 1250 mm



Other mobile units

Mobile skips

Long-lasting welded steel construction with tilting bin made from 2 mm sheet steel, watertight version also available.

600-litre trolley is reinforced with round tube. Load-bearing chassis of channel steel, forklift pockets made from enclosed hollow structural steel profiles 120 x 60 x 3 mm or 160 x 90 x 4.5 mm.

Wheels

- Axle: Ø 25 mm
 - Axle wheels: Ø 250 mm
 - Steering caster: Ø 200 mm
- All wheels have solid rubber tyres and are mounted on ball-bearings for smooth running.
For size 600 l with elastic tyres.



Large shatterproof wheels with bolted sheet steel rim
Wheel dia. 250 mm, wheel width 60 mm for dia. 25 mm axle.



Forged drop guard prevents accidental tipping of the bin.



Forklift pockets in two dimensions:
Internal dimensions 114 x 54 mm or 150 x 80 mm
With full lock (for secure positioning) as standard. For reasons of space, not possible for 250-litre version type B



Securing chain prevents the trolley from sliding away during accidental inclination of the forklift masts.
■ Total length approx. 1000 mm
■ Available for surcharge

Forklift pocket dimensions of the different versions:

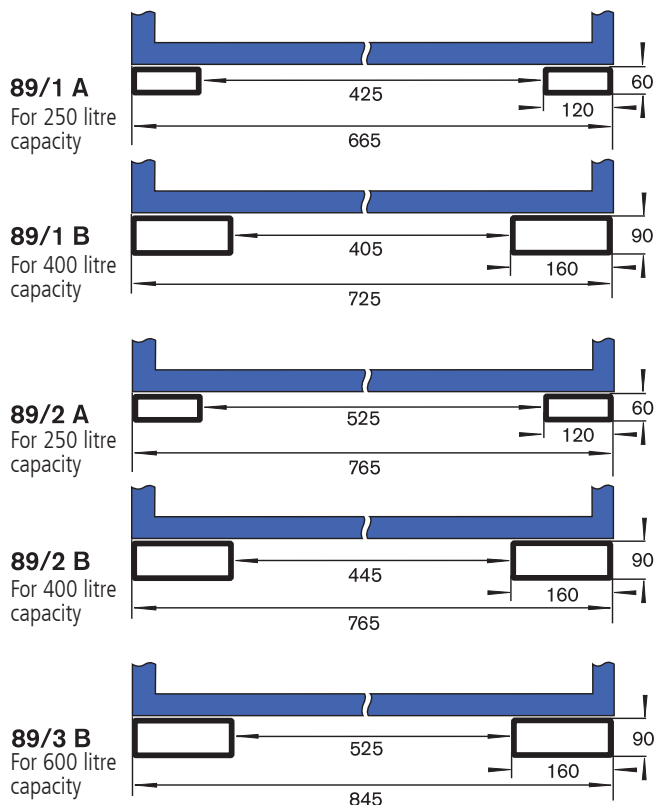

Mobile skips

Mobile logistics systems

Additional equipment

- Cover lid with welded handle
- Securing chain



250 litres

400 litres

600 litres (steering caster with lock for all sizes apart from 04.18-1010 and 04.18-1011)

Item no.	Dimensions in mm (WxDxH)	Bin volume	Description	Version
04.18-1001	1140 x 815 x 933	250 litres	Height at the chute: 855 mm, Internal dimensions: 520/545 x 570 x 595 mm	Watertight, without forklift pockets
04.18-1003	1330 x 925 x 942	400 litres	Height at the chute: 842 mm, Internal dimensions: 607/712 x 670 x 603 mm	Watertight, without forklift pockets
04.18-1005	1540 x 1000 x 1090	600 litres	Height at the chute: 970 mm, Internal dimensions: 700/775 x 750 x 750 mm	Watertight, without forklift pockets
04.18-1007	1140 x 815 x 933	250 litres	Height at the chute: 855 mm, Internal dimensions: 520/545 x 570 x 595 mm	Watertight, with forklift pockets, type A
04.18-1009	1330 x 925 x 942	400 litres	Height at the chute: 842 mm, Internal dimensions: 607/712 x 670 x 603 mm	Watertight, with forklift pockets, type A
04.18-1011	1140 x 815 x 933	250 litres	Height at the chute: 855 mm, Internal dimensions: 520/545 x 570 x 595 mm	Watertight, with forklift pockets, type B
04.18-1013	1330 x 925 x 942	400 litres	Height at the chute: 842 mm, Internal dimensions: 607/712 x 670 x 603 mm	Watertight, with forklift pockets, type B
04.18-1015	1540 x 1000 x 1090	600 litres	Height at the chute: 970 mm, Internal dimensions: 700/775 x 750 x 750 mm	Watertight, with forklift pockets, type B

Additional equipment

- Locks for the steering caster included in the scope of delivery (not 04.18-1011)

Item no.	Description	Version
04.18-1016	Securing chain	Length: 1000 mm

Item no.	Description	Version
04.18-1017	Cover lid, galvanised	For 250 litre size
04.18-1018		For 400 litre size
04.18-1019		For 600 litre size

Sieve bottom with ball valve

On request, we supply the watertight versions with a full, bolted sieve bottom. The distance from the lower bottom is approx. 100 mm. Ball valve for the draining of accumulated liquid.

- Surcharge for sieve bottom and ball valve

Item no.	Bin volume	Ball valve
04.18-89525	250 litres	R ¾" connection
04.18-89540	400 litres	R ¾" connection
04.18-89560	600 litres	R 1" connection

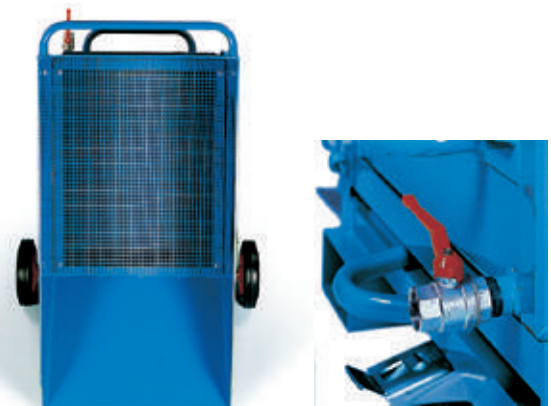

Other mobile units

Steel tube table trolley 850 x 450 mm

- Load capacity 300 kg
- Sturdy steel tube construction, tube Ø 27 mm
- Bars optionally of angular steel 15 mm, beech 30 mm or beech glulam 75 mm high
- Load areas internal dimensions: Steel 800 x 500 mm, wood 774 x 474 mm
- 2x fixed and 2x steering caster
- With lock, full rubber, black Ø 125 mm
- Load areas made of multiplex wood with heavy-duty surface
- Powder coating in RAL 5010 Gentian blue as standard

The equipment arrives as a ready-made trolley.
No assembling required before use.

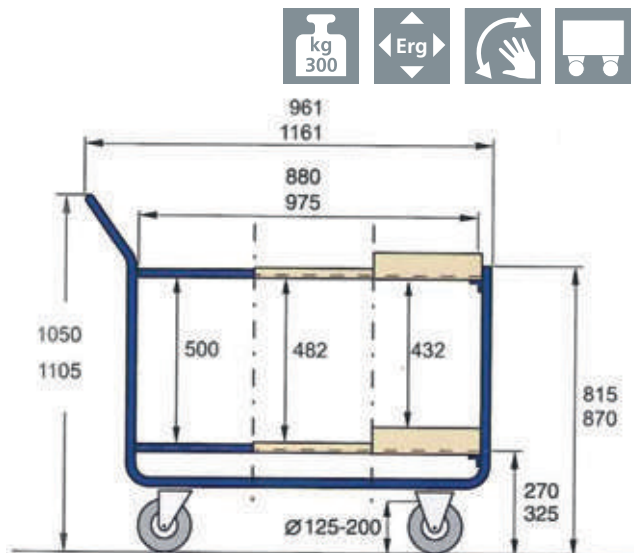

Steel tube table trolley

- 2x load area 800 x 500 mm
- Angular steel 15 mm

Item no.

04.11.1054



Steel tube table trolley

- 2x load area 800 x 500 mm
- Beech wood 30 mm

Item no.

04.11.1072



Steel tube table trolley

- 2x load area 800 x 500 mm
- Beech glulam 75 mm

Item no.

04.11.1099



Steel tube table trolley

- 3x load area 800 x 500 mm
- Angular steel 15 mm

Item no.

04.11.1063



Steel tube table trolley

- 3x load area 800 x 500 mm
- Beech wood 30 mm

Item no.

04.11.1081



Steel tube table trolley

- 3x load area 800 x 500 mm
- Beech glulam 75 mm

Item no.

04.11.1108

Steel tube table trolley 1000 x 600 mm

Mobile logistics systems

- Load capacity 300 kg
- Sturdy steel tube construction, tube Ø 27 mm
- Bars optionally of angular steel 15 mm, beech 30 mm or beech glulam 75 mm high
- Load areas internal dimensions: Steel 1000 x 600 mm, wood 974 x 574 mm
- 2x fixed and 2x steering caster with locks, full rubber, black, Ø 125 mm
- Load areas made of multiplex wood with heavy-duty surface
- Powder coating in RAL 5010 Gentian blue as standard



The equipment arrives as a ready-made trolley.
No assembling required before use.



Steel tube table trolley

- 2x load area 1000 x 600 mm
- Load area: Steel 15 mm

Item no.	Casters
04.11.1058	Ø 125 mm



Steel tube table trolley

- 2x load area 1000 x 600 mm
- Load area: Beech wood 30 mm

Item no.	Casters
04.11.1076	Ø 125 mm



Steel tube table trolley

- 2x load area 1000 x 600 mm
- Load area: Beech wood 75 mm

Item no.	Casters
04.11.1103	Ø 125 mm



Steel tube table trolley

- 3x load area 1000 x 600 mm
- Load area: Steel 15 mm

Item no.	Casters
04.11.1067	Ø 125 mm



Steel tube table trolley

- 3x load area 1000 x 600 mm
- Load area: Beech wood 30 mm

Item no.	Casters
04.11.1085	Ø 125 mm



Steel tube table trolley

- 3x load area 1000 x 600 mm
- Load area: Beech wood 75 mm

Item no.	Casters
04.11.1112	Ø 125 mm

Other mobile units

Transport trolleys

- Ergonomic handle
- 2x fixed and 2x steering caster with locks, Ø 125 mm
- 300 kg load capacity with uniform load
- Tubes 40 x 20 mm
- Plywood support surface, 855 x 575 x 15 mm



- With wooden bottom

Item no.	Dimensions in mm (WxDxH)
04.900.01	900 x 620 x 860



- With wooden bottom and rear panel

Item no.	Dimensions in mm (WxDxH)
04.900.02	900 x 620 x 860



- With wooden bottom
- Front and rear panel

Item no.	Dimensions in mm (WxDxH)
04.900.03	900 x 620 x 860



- With 2 levels of wooden shelves

Item no.	Dimensions in mm (WxDxH)
04.900.04	900 x 620 x 860

Accessories



Label pouch A4

Item no.
04.900.10



Writing tablet A4

Item no.
04.900.11



Zinc panel cover

Item no.
04.900.13



Tray

Item no.
04.900.12

Mesh-sided trolleys

Mobile logistics systems

- Solid welded steel construction
- Support frame and corner profiles in angle irons, 40 x 40 x 4 mm
- Bottom made of multiplex wood with heavy-duty surface
- All trolleys have 2 steering casters and 2 fixed casters with total brakes on the steering casters in accordance with EN 1757-3
- Wheel diameter and width 200 x 50 mm



Completely closed

With half cover

With half cover and cover lid

Mesh-sided trolleys

- 2x fixed and 2x steering caster with locks
- Full rubber, black, Ø 200 mm

Tyres	Version	Item no.	Dimensions in mm (WxDxH)
Ball bearing	Half open	04.12.1211	1050 x 700 x 800
		04.12.1212	1250 x 800 x 800
	Completely closed	04.12.1207	1050 x 700 x 800
		04.12.1208	1250 x 800 x 800
	Half covered	04.12.1215	1050 x 700 x 800
		04.12.1216	1250 x 800 x 800



Accessories

Version	Item no.	Version
Cover lid	04.48.86	1050 x 700 mm
	04.48.87	1250 x 800 mm
Lid closure	04.48.84	Single
	04.48.85	Double

Other mobile units

KUBIK – orderliness by system, square and practical

- Solid sheet steel construction
- Reinforced handle spars with safety handles
- Either plastic wheels or solid rubber tyres
- With roller bearings or smooth-running ball bearings
- Solid rubber wheels for smooth floors

Features:

- Safety handles made from high-strength plastic
- Supplied without decoration



Kubik-1

- As illustrated

Item no.	Dimensions in mm (WxDxH)	Plastic rollers
86.1000	620 x 620 x 445	Ø 50 mm
86.1000.100	620 x 620 x 505	Ø 100 mm



Kubik-2

- As illustrated

Item no.	Dimensions in mm (WxDxH)	Plastic rollers
86.2000	620 x 620 x 805	Ø 50 mm
86.2000.100	620 x 620 x 865	Ø 100 mm



Kubik-3

- As illustrated

Item no.	Dimensions in mm (WxDxH)	Plastic rollers
86.3000	620 x 620 x 1165	Ø 50 mm
86.3000.100	620 x 620 x 1225	Ø 100 mm

Accessories

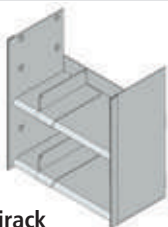

Minirack

- 302 x 142 x 332 mm

Item no.
86.7010



Minirack

- 302 x 210 x 332 mm

Item no.
86.7020



Maxirack

- 302 x 300 x 332 mm

Item no.
86.7030



Shelving divider

- 200 x 140 mm

Item no.
86.7300



Tabletop

Item no.
86.7075

Supplied without attachment parts such as racks, shelving dividers, tabletops, perforated walls, wardrobe rails



Kubik-3-4

■ As illustrated

Item no.	Dimensions in mm (WxDxH)	Plastic rollers
86.3100	620 x 620 x 1165	Ø 50 mm
86.3100.100	620 x 620 x 1225	Ø 100 mm



Kubik-4

■ As illustrated

Item no.	Dimensions in mm (WxDxH)	Plastic rollers
86.4000	620 x 620 x 1525	Ø 50 mm
86.4000.100	620 x 620 x 1585	Ø 100 mm



Kubik-5-3

■ As illustrated

Item no.	Dimensions in mm (WxDxH)	Plastic rollers
86.5200	620 x 620 x 1885	Ø 50 mm
86.5200.100	620 x 620 x 1945	Ø 100 mm

Accessories



Tabletop

■ 620 x 620 x 12 mm

Item no.
86.7070



Rack divider

■ 295 x 332 mm

Item no.
86.6140

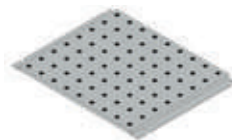

Perforated panel

■ 295 x 382 mm

Item no.
86.7100



Mirror

■ 295 x 332 mm

Item no.
86.7150



Wardrobe rail

■ 618 mm width

Item no.
86.7200

Other mobile units

KUBIK – 5S



Back

NEW



Paper towel roll



Waste bins



Disinfectant dispenser



Kubik 5S cleaning station duo

- 1 x perforated side wall, consisting of 4 x individual panel
- 1 x solid side wall with push handle
- Top bevelled on 4 sides
- Recessed rear wall: 2 x shelves, 1 x broom, 1 x hand brush and 1 x dustpan
- Interior: 2 x waste bins made of galvanised sheet steel
- 1 x unwind holder incl. paper towel roll
- 2 x fixed casters and 2 x steering casters with lock Ø 125 mm
- Delivery without disinfectant dispenser

Item no.	Dimensions in mm (WxDxH)
86.CLEAN5S-1	690 x 530 x 1690



Kubik 5S cleaning station trio

- 1 x perforated side wall, consisting of 4 x individual panel
- 1 x solid side wall with push handle
- Top bevelled on 4 sides
- Recessed rear wall: 2 x shelves, 1 x broom, 1 x hand brush and 1 x dustpan
- Interior: 3 x waste bins made of galvanised sheet steel
- 1 x unwind holder incl. paper towel roll
- 2 x fixed casters and 2 x steering casters with lock Ø 125 mm

Item no.	Dimensions in mm (WxDxH)
86.CLEAN5S-2	690 x 530 x 1690

NEW



Disinfectant dispenser*

- Airtight closed system (no germination)
- Constant dosage of 1.00 ml
- Incl. metal adapter for perforated wall and drip-catcher, allows for simple mounting an optimal cleaning
- Incl. high-performance batteries

Item no.	Dimensions in mm (WxDxH)
03.H8719	105 x 108 x 280

*Delivery without disinfectant



Disinfectant

- Alcoholic solution for hygienic hand disinfection
- Re-greasing, spectrum MRSA, Noro
- HBV/HIV, exposure time 3 ml/30 sec., VAH-listed, 650 ml vacuum bag

Item no.
03.BH8719

NEW

Height adjustable and mobile

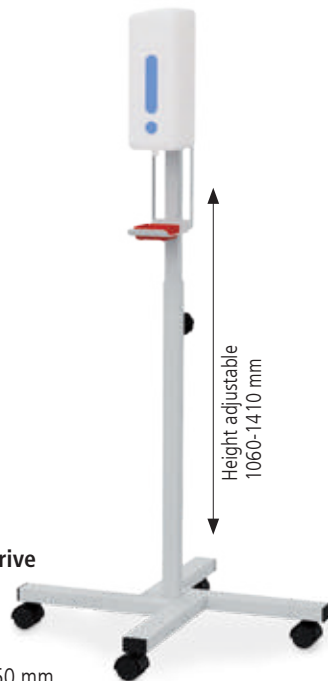

Disinfectant dispenser easy drive

- 4 x plastic steering castors, thereof 2 with brake Ø 50 mm
- 1 x disinfectant dispenser
- Height adjustable on a grid of 50 mm
- Drip-catcher for optimal cleaning

Item no.	Dimensions in mm (WxDxH)
05.H10.01	655 x 655 x 1060-1410



Infopoint

- Solid sheet steel construction
- Reinforced handle bars with aluminium handles
- Easy to move
- Space-saving and clearly arranged
- Perforated grid: 38mm
- Solid rubber wheels for smooth floors
- 4 x steering castors Ø 125 mm, 2 x with brakes
- Weight: approx. 50 kg
- 8 x perforated wall, 566 mm wide, perforation 10x10 mm

Item no.	Dimensions in mm (WxDxH)
04.IP001	650 x 650 x 1970



Other mobile units

KUBIK – 5S

NEW



Health Protection Line Kubik

- Solid sheet steel construction
- Reinforced handle bars with aluminium handles
- Space-saving and clearly arranged
- Perforation: 10 x 10 mm, spacing: 38 mm
- 1 x push handle
- 2 x hinged door
- 4 x perforated wall on the side
- 1 x perforated back wall
- 1 x shelf with recess for waste Ø 148 mm
- Easy to move
- Solid rubber wheels for smooth floors
- 4 x steering castors Ø 125 mm, 2 x with brakes

Waste bin, 40 Liter

- White, large filling capacity, ABS plastic
- Free standing or wall mounted

Item no.	Dimensions in mm (WxDxH)
03.H8780	320 x 250 x 500

Bin liners

- 50 litres, white, 9 rolls of 40 bags each

Item no.
03.H8769

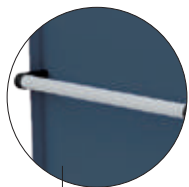

Push handle



Contactless use



- Delivery without accessories, as described above
- Waste bin can be stowed behind hinged doors

- 1 x waste bin, stowed behind the hinged doors
- 1 x disinfectant dispenser
- 1 x towel dispenser
- Incl. adapters for accessories for easy mounting to perforated walls and optimal cleaning

Item no.	Dimensions in mm (WxDxH)
86.H01KUB5	730 x 550 x 1690

Item no.	Dimensions in mm (WxDxH)
86.H02KUB5	730 x 550 x 1690

The sturdy case cabinet made of sheet steel with 4 compartments ensures quick and clear access to your flex-box at the workplace. It is suitable for attachment on the wall and as a free-standing or stackable unit. Both plastic and metal flex-boxes can be used.

- Eco-friendly powder coating (light grey)
- High stability and load capacity
- Individual drawer interlocking prevents unwanted opening, one-handed operation
- Smooth-running ball bearing full pull-outs with self-retraction
- Special colours, silkscreens, stickers possible on request



Flex-box cases on/
from page 255



- Open fronted storage bins**
- Polypropylene

Item no.	Dimensions in mm (WxDxH)
03.900.001	100 x 95 / 65 x 50
03.900.002	100 x 175 / 140 x 75
03.900.003	145 x 235 / 195 x 125



- Support rail for open fronted storage bins**

Item no.	Width in mm
03.900.06	300

Mobile flex-box cabinet

- Beech multiplex top 30 mm
- Side handles at top
- 2x case cabinet with smooth side wall
- Individual drawer interlocking prevents unwanted opening One-handed operation
- Smooth-running ball bearing full pull-outs with self-retraction
- 4x steering caster, Ø 100 mm, thereof 2 with locks

Item no.	External dimensions in mm (WxDxH)
04.50.37.2*	607 x 475 x 1132

Perforated wall

- For hanging the range of hooks

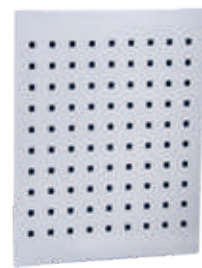

Item no.	External dimensions in mm (WxH)
04.50.37LW	370 x 462

Bottle holder

- For mounting on the perforated wall



Item no.	Dimensions in mm
03.900.43	Ø 90

Roll holder

- For mounting on the perforated wall



Item no.	Dimensions in mm (WxDxH)
03.900.42	140 x 106 x 71

*Supplied without bins, hooks, case, perforated walls and tools.

Mobile workplace systems

Mobile workraster units



workraster workplace systems

The mobile units of the workraster series enable quick access and maximum mobility. More manoeuvrable than ever before with 4 steering casters with a diameter of 125 mm (2 with locks). Simple handling thanks to user-friendly plastic handles. As transport or storage trolleys, whether used as a mobile workstation or for storing tools in the perforated walls,

they can be used in any situation. Thanks to a height grid of 38 mm, various heights and depths, individual equipping is possible on one or both sides. Shelves can be added to supply material as can many parts of the multi-board. The accessories of the workraster range are compatible.

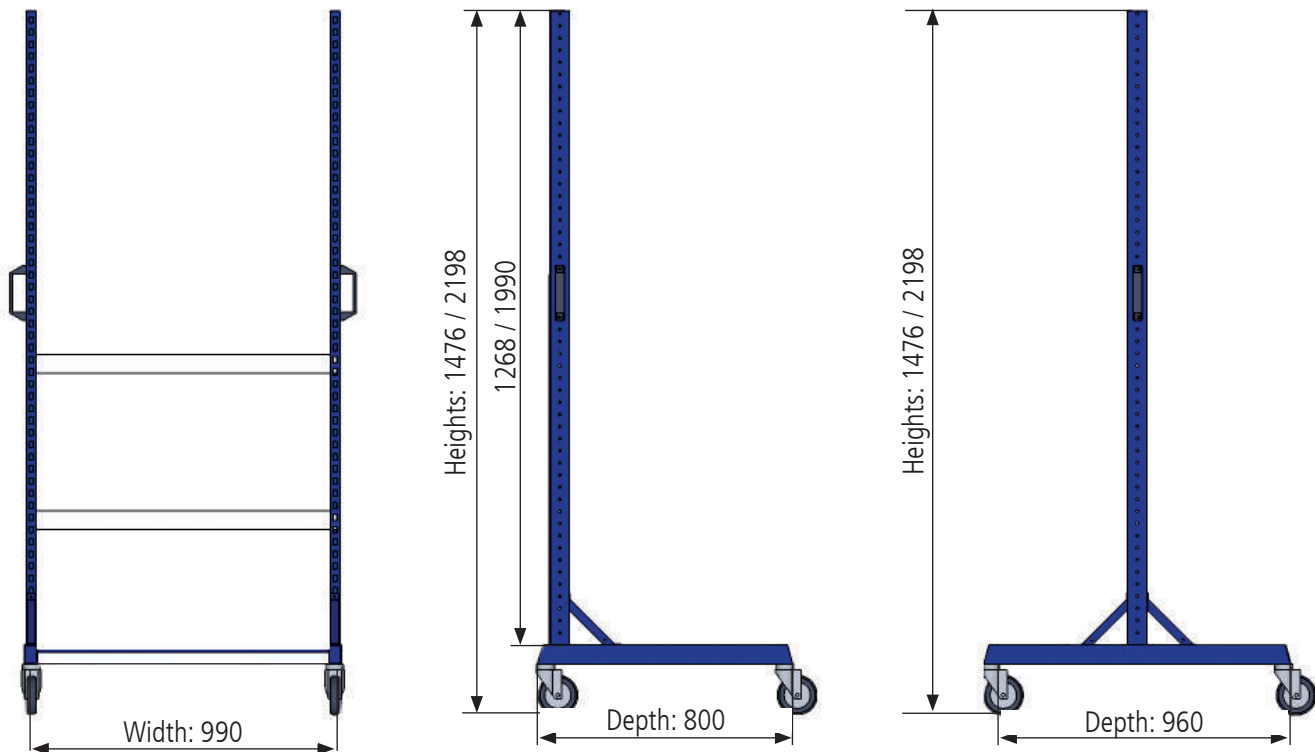

Mobile workraster units: Basic dimensions

The mobile workraster units can be arranged in different depths and heights and can be used just as flexibly and individually as the series itself.



- Ergonomic plastic handle
- 4x steering caster, Ø 125 mm with lock
- Load capacity 200 kg

Accessories, such as perforated walls see page 277



Mobile workraster unit, single-sided

- 1x bottom plate

WR
E

Item no.	Dimensions in mm (WxDxH)
07.8310.811	1000 x 800 x 1476



Mobile workraster unit, single-sided

- 1x bottom plate

WR
E

Item no.	Dimensions in mm (WxDxH)
07.8310.821	1000 x 800 x 2198



Mobile workraster unit, double-sided

- 1x bottom plate

WR
DK

Item no.	Dimensions in mm (WxDxH)
07.8310.912	1000 x 960 x 1476



Mobile workraster unit, double-sided

- 1x bottom plate

WR
DK

Item no.	Dimensions in mm (WxDxH)
07.8310.922	1000 x 960 x 2198



Mobile workplace systems

Mobile workraster units



- Ergonomic plastic handle
- 4x steering caster, Ø 125 mm with lock
- Load capacity 200 kg



Mobile workraster unit, single-sided

- 1x bottom plate
- 1x perforated wall
- 2x bin carrier
- 1x shelf, 220 mm
- 1x shelf, 320 mm
- 1x bin strip with 6x drawer
- Open fronted storage bins: 12x size 4, 12x size 3, 8x size 2

WR
E

Item no.	Dimensions in mm (WxDxH)
07.8310.01	1000 x 800 x 2198



Mobile workraster unit, single-sided

- Beech multiplex worktop 1500 x 750 x 25 mm
- 1x bin carrier
- 1x shelf, 220 mm
- 2x perforated wall
- Open fronted storage bins: 8x size 2, 6x size 3

WR
E

Item no.	Dimensions in mm (WxDxH)
07.8310.50	1000 x 800 x 2198



Mobile workraster unit, double-sided

- 1x bottom plate
- 2x perforated wall
- 4x bin carrier
- 4x Euro bin 400 x 300 mm
- Open fronted storage bins: 16x size 2, 12x size 3, 4x size 4
- 1x bin strip with 3x drawer

WR
DK

Item no.	Dimensions in mm (WxDxH)
07.8310.02	1000 x 960 x 1476



Mobile workraster unit, double-sided

- 1x bottom plate
- 2x perforated wall
- 2x bin carrier
- 2x shelf, 220 mm
- Open fronted storage bins: 8x size 2, 18x size 3, 8x size 4

WR
DK

Item no.	Dimensions in mm (WxDxH)
07.8310.03	1000 x 960 x 1476



- Ergonomic plastic handle
- 4x steering caster, Ø 125 mm with lock
- Load capacity 200 kg



Mobile workraster unit, single-sided

- 1x bottom plate
- 1x multi-roller shutter cabinet
- 1x bin carrier
- 1x shelf, 220 mm
- Open fronted storage bins: 8x size 2, 6x size 3, 8x size 4

WR
E

Item no.	Dimensions in mm (WxDxH)
07.8310.04	1000 x 800 x 2198



Mobile workraster unit, single-sided

- 1x bottom plate
- 2x bin carrier
- 4x Euro bin 400 x 300 mm
- 2x perforated wall
- Open fronted storage bins: 6x size 2, 8x size 3
- Small parts magazine with 12x drawer
- 1x bin strip with 6x drawer

WR
E

Item no.	Dimensions in mm (WxDxH)
07.8310.05	1000 x 800 x 1476



Mobile workraster unit, double-sided

- 1x bottom plate
- 1x multi-roller shutter cabinet
- 2x shelf, 220 mm
- 2x perforated wall
- 3x Euro bin 400 x 300 mm
- Open fronted storage bins: 12x size 3, 4x size 4

WR
DK

Item no.	Dimensions in mm (WxDxH)
07.8310.06	1000 x 960 x 2198



Mobile workraster unit, double-sided

- 1x bottom plate
- 2x shelf, 220 mm
- 2x bin carrier
- 2x perforated wall
- 3x Euro bin 400 x 300 mm
- Open fronted storage bins: 4x size 4, 18x size 3, 8x size 2

WR
DK

Item no.	Dimensions in mm (WxDxH)
07.8310.07	1000 x 960 x 2198

Supplied without hooks, tools and decoration

Mobile workplace systems

Mobile workergo units



Mobile workergo unit

- Beech multiplex worktop 25 mm
- Stepless height adjustment with clamp fixing
- Load capacity 200 kg
- 2x steering caster, Ø 100 mm with lock
- 2x fixed caster, Ø 100 mm

Multi-board setup

- 2x support column
- 1x equipment rail
- 1x overhead frame with lighting
- 1x shelf, 220 mm
- 1x energy duct with 3x earthed sockets and on/off switch
- 2x perforated wall
- 1x document holder

Item no.	Dimensions in mm (WxDxH)	Version
4M150KL75GB	1500 x 750 x 820 – 1160	Mobile workergo unit
4C150-7	1500 x 1255	Multi-board setup



Mobile workergo unit

- Beech multiplex worktop 25 mm
- Stepless height adjustment with clamp fixing
- Load capacity 200 kg
- 2x steering caster, Ø 100 mm with lock
- 2x fixed caster, Ø 100 mm

Multi-board setup

- 3x support column
- 1x equipment rail
- 1x overhead frame with lighting
- 2x shelf, 220 mm
- 1x energy duct with 3x earthed sockets and on/off switch
- 4x perforated wall
- 1x document holder

Item no.	Dimensions in mm (WxDxH)	Version
4M200KL75GB	2000 x 750 x 820 – 1160	Mobile workergo unit
4C200-7	2000 x 1255	Multi-board setup

Mobile workline units

Mobile logistics systems



workline

WL
1



- 2x shelf, beech multiplex shelf 25 mm
- Extendable and height-adjustable

Item no.	Dimensions in mm (WxDxH)
07.59.75	700 x 610 x 950
07.59.95	900 x 610 x 950



- 3x shelf, beech multiplex shelf 25 mm
- Extendable and height-adjustable

Item no.	Dimensions in mm (WxDxH)
07.55.75	700 x 610 x 1510
07.55.95	900 x 610 x 1510



- Beech multiplex top 25 mm
- Stepless height adjustment
- Load capacity 200 kg

Item no.	Dimensions in mm (WxDxH)
07.51.85	750 x 750 x 980 – 1250

Mobile workline tables



- Beech multiplex worktop 25 mm
- Stepless height adjustment
- Load capacity 200 kg

Item no.	Dimensions in mm (WxDxH)
07.51.87	1500 x 750 x 980 – 1250



- Beech multiplex worktop 25 mm
- Stepless height adjustment
- Load capacity 200 kg

Item no.	Dimensions in mm (WxDxH)
07.51.86	1000 x 750 x 980 – 1250





Hinged and sliding door cabinets





New

Individual hinged door cabinets

Page 532



Multifunction cabinets

Page 536



Open fronted storage bin cabinets

Page 539



Hinged door cabinets with shelves

Page 542



New

Environment protection cabinets, fireproof cabinets and cleaning cabinets

Page 543



Heavy-duty cabinets

Page 546



Cabinets with windows

Page 547



New

Battery charging cabinet

Seite 548



Cabinets with sliding doors

Page 550



Individual hinged door cabinets

Hinged door cabinets T500 | wide 530 mm

- Robust, welded sheet steel construction
- Resistant powder coating
- Drawers/pull-out shelf with full pull-out 100 %, load capacity 50 kg
- Adjustable steel shelves, load capacity 80 kg
- Doors with moulded recess cylinder lock
- When using drawers and pull-outs, the opening angle must be 130°

New



Hinged door cabinet T500

- 1 x drawer
- 2 x shelves

Item no.	Dimensions in mm (WxDxH)
04.153.001	530 x 500 x 1019

Drawers

- Drawers with full pull-out (FP) 100 %
- Usable drawer dimension: **450 x 400 mm (B x T)**

Item no.	Front height	Shell height	Usable height	Load capacity
60.046.075VA	75	59	60	50 kg
60.046.100VA	100	85	90	50 kg
60.046.150VA	150	135	140	50 kg
60.046.200VA	200	185	190	50 kg
60.046.250VA	250	185	240	50 kg
60.046.300VA	300	185	290	50 kg
60.046.100VA-75	100	85	90	75 kg
60.046.150VA-75	150	135	140	75 kg
60.046.200VA-75	200	185	190	75 kg
60.046.250VA-75	250	185	2240	75 kg
60.046.300VA-75	300	185	290	75 kg



Hanging folder frame R 18-16

- Pull-out 100%, load capacity 50 kg

Item no.	Dimensions in mm (WxDxH)
04.053.015	475 x 328 x 80



Pull-out shelf R 18-16

- Shelf with upstand, pull-out 100%, load capacity 50 kg
- Includes fastening material

Item no.	Dimensions in mm (WxDxH)
04.053.014	476 x 422 x 70



Shelf R 18-16

- load capacity 80 kg
- Includes fastening material

Item no.	Dimensions in mm (WxDxH)
04.053.013	475 x 443 x 22



04.153.10FLS



04.153.18FLS

Housing with hinged doors

Item no.	Dimensions in mm (WxDxH)	Usable height
04.153.10FLS	530 x 500 x 1019	900
04.153.18FLS	530 x 500 x 1838	1719

Hinged door cabinets T500 | wide 680 mm

Hinged and sliding door cabinets

- Robust, welded sheet steel construction
- Resistant powder coating
- Drawers/pull-out shelf with full pull-out 100 %, load capacity 50 kg
- Adjustable steel shelves, load capacity 80 kg
- Doors with moulded recess cylinder lock
- When using drawers and pull-outs, the opening angle must be 130°



Hinged door cabinet T500

- 2 x drawers
- 1 x shelf
- 1x hanging folder frame

Item no.	Dimensions in mm (WxDxH)
04.106.001	680 x 500 x 1019

Drawers

- Drawers with full pull-out (FP) 100 %
- Usable drawer dimension: **600 x 400 mm (B x T)**

Item no.	Front height	Shell height	Usable height	Load capacity
60.068.175VA	75	59	60	50 kg
60.068.100VA	100	85	90	50 kg
60.068.150VA	150	135	140	50 kg
60.068.200VA	200	185	190	50 kg
60.068.250VA	250	185	240	50 kg
60.068.300VA	300	185	290	50 kg
60.068.100VA-75	100	85	90	75 kg
60.068.150VA-75	150	135	140	75 kg
60.068.200VA-75	200	185	190	75 kg
60.068.250VA-75	250	185	240	75 kg
60.068.300VA-75	300	185	290	75 kg



Hanging folder frame R 24-16

- Pull-out 100%, load capacity 50 kg

Item no.	Dimensions in mm (WxDxH)
04.060.015	625 x 382 x 80



Pull-out shelf R 24-16

- Shelf with upstand, pull-out 100%, load capacity 50 kg
- Includes fastening material

Item no.	Dimensions in mm (WxDxH)
04.060.014	626 x 442 x 70



Shelf R 24-16

- load capacity 80 kg
- Includes fastening material

Item no.	Dimensions in mm (WxDxH)
04.060.013	625 x 443 x 22

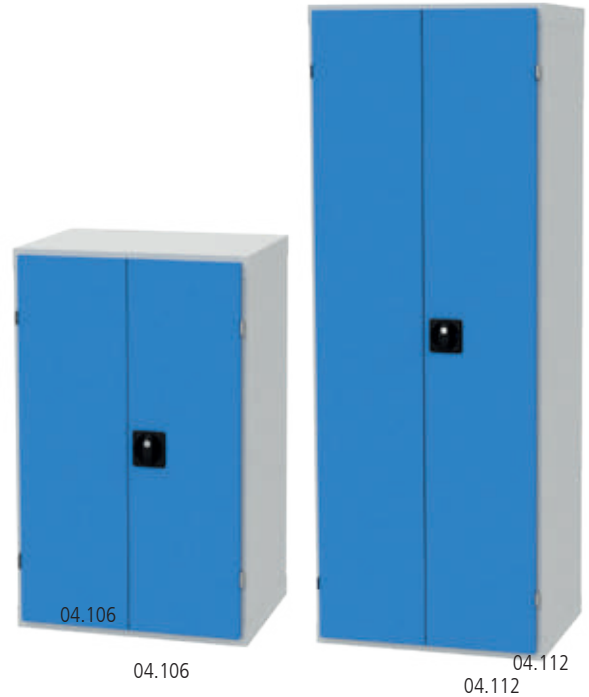

Housing with hinged doors

Item no.	Dimensions in mm (WxDxH)	Usable height
04.106	680 x 500 x 1019	900
04.112	680 x 500 x 1838	1719

Individual hinged door cabinets

Hinged door cabinets T500 | wide 980 mm

- Robust, welded sheet steel construction
- Resistant powder coating
- Drawers/pull-out shelf with full pull-out 100 %, load capacity 50 kg
- Adjustable steel shelves, load capacity 80 kg
- Doors with moulded recess cylinder lock
- When using drawers and pull-outs, the opening angle must be 130°



Hinged door cabinet T500

- 1x drawer
- 1x pull-out shelf
- 1x hanging folder frame

Item no.	Dimensions in mm (WxDxH)
04.109.001	980 x 500 x 1019

Drawers

- Drawers with full pull-out (FP) 100 %
- Usable drawer dimension: **900 x 400 mm (B x T)**

Item no.	Front height	Shell height	Usable height	Load capacity
60.098.075VA	75	59	60	50 kg
60.098.100VA	100	85	90	50 kg
60.098.150VA	150	135	140	50 kg
60.098.200VA	200	185	190	50 kg
60.098.250VA	250	185	240	50 kg
60.098.300VA	300	185	290	50 kg
60.098.100VA-75	100	85	90	75 kg
60.098.150VA-75	150	135	140	75 kg
60.068.200VA-75	200	185	190	75 kg
60.068.250VA-75	250	185	240	75 kg
60.068.300VA-75	300	185	290	75 kg



Hanging folder frame R 18-16

- Pull-out 100%, load capacity 50 kg

Item no.	Dimensions in mm (WxDxH)
04.090.015	925 x 382 x 80



Pull-out shelf R 18-16

- Shelf with upstand, pull-out 100%, load capacity 50 kg
- Includes fastening material

Item no.	Dimensions in mm (WxDxH)
04.090.014	926 x 442 x 70



Shelf R 18-16

- load capacity 80 kg
- Includes fastening material

Item no.	Dimensions in mm (WxDxH)
04.090.013	925 x 443 x 22

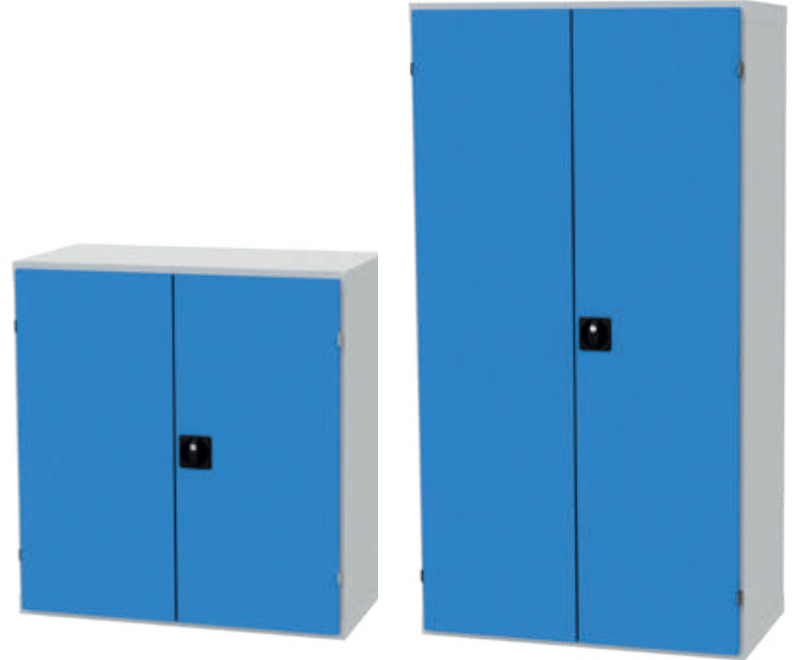

Housing with hinged doors

Item no.	Dimensions in mm (WxDxH)	Usable height
04.109	980 x 500 x 1019	900
04.118	980 x 500 x 1838	1719

Hinged door cabinets T500 | wide 980 mm

Hinged and sliding door cabinets

- Robust, welded sheet steel construction
- Resistant powder coating
- Drawers/pull-out shelf with full pull-out 100 %, load capacity 50 kg

- Adjustable steel shelves, load capacity 80 kg
- Doors with moulded recess cylinder lock
- When using drawers and pull-outs, the opening angle must be 130°



Housing with hinged doors and Plexglas insert

- Price without drawers. Drawers have to be combined individually

Item no.	Dimensions in mm (WxDxH)	Usable height
04.119	980 x 500 x 1538 + 300 (drawers)	1538+300

Housing with hinged doors and Plexglas insert

- Price without drawers. Drawers have to be combined individually

Item no.	Dimensions in mm (WxDxH)	Usable height
04.117	980 x 500 x 1838	1719

Display cabinet T500 R 36-16

- 3x shelf, fixed
- 1x shelf, pull-out
- 1x intermediate shelf
- 2x drawers, not lockable

Item no.	Dimensions in mm (WxDxH)
04.188.002	980 x 500 x 1838



Multifunction cabinets

Multifunction cabinet T500 R 36-16

- When using drawers and pull-outs, the opening angle must be 130°
- Supplied without decoration, hooks and open fronted storage bins



Multifunction cabinet T500 R 36-16

- 2x shelf, fixed, 500 mm
- 1x perforated wall
- 2x hinged door with perforated wall

Item no.	Dimensions in mm (WxDxH)
04.118.023	980 x 500 x 1838



Multifunction cabinet T500 R 36-16

- 1x drawer 100 mm, FP 50 kg
- 1x drawer 200 mm, FP 50 kg
- 1x intermediate shelf
- 1x perforated wall
- 2x hinged door with perforated wall

Item no.	Dimensions in mm (WxDxH)
04.118.024	980 x 500 x 1838

Individual components

Drawers R 36-16

- Drawers with full pull-out (FP) 100 %
- Usable drawer dimension: **900 x 400 mm (B x T)**

Item no.	Dimensions in mm (WxDxH)	Front height	Shell height	Load capacity
60.098.075VA	75	59	60	50 kg
60.098.100VA	100	85	90	50 kg
60.098.150VA	150	135	140	50 kg
60.098.200VA	200	185	190	50 kg
60.098.250VA	250	185	240	50 kg
60.098.300VA	300	185	290	50 kg
60.098.100VA-75	100	85	90	75 kg
60.098.150VA-75	150	135	140	75 kg
60.068.200VA-75	200	185	190	75 kg
60.068.250VA-75	250	185	240	75 kg
60.068.300VA-75	300	185	290	75 kg



Shelf R 36-16

- Includes fastening material

Item no.	Dimensions in mm (WxDxH)	Load capacity
04.090.013	925 x 443 x 22	80 kg



Pull-out shelf R 36-16

- Shelf with upstand, pull-out 100%
- Includes fastening material

Item no.	Dimensions in mm (WxDxH)	Load capacity
04.090.014	926 x 442 x 70	50 kg



Multifunction cabinet T500 R 36-16

Hinged and sliding door cabinets

- When using drawers and pull-outs, the opening angle must be 130°
- It is not possible to install a shelf in front of the perforated rear wall
- **Supplied without decoration, hooks and open fronted storage bins**



Multifunction cabinet T500 R 36-16

- 2x hinged door with perforated wall
- 1x perforated wall
- 3x shelf

Item no.	Dimensions in mm (WxDxH)
04.118.026	980 x 500 x 1838

Accessories



Hook assortment

- Further hook assortments can be found on page 312

Item no.	Parts
03.87.395-18	18 parts

Support rail for open fronted storage bins

Item no.	Width in mm
03.900.05	450
03.900.06	300

Open fronted storage bins

Item no.	Width in mm
03.900.001	Size 1 100 x 95 / 65 x 50
03.900.002	Size 2 100 x 170 / 140 x 80
03.900.003	Size 3 145 x 230 / 195 x 125
03.900.004	Size 4 200 x 350 / 300 x 145
03.900.005	Size 5 200 x 350 / 300 x 200

Range of open fronted storage bin as illustrated in the respective cabinets

Item no.	Type
04.118.023/1	4x size 4, 6x size 3, 8x size 2, 6x size 1
04.118.024/1	6x size 3, 8x size 2, 6x size 1
04.118.026/1	4x size 4, 12x size 3, 48x size 2

Open fronted storage bin cabinets





The 3-bolt Ergo-Lock 4.0 lock is not only equipped with 2 keys but also a patented mechanism: Simply press to lock! It is only available for hinged door cabinets from page 540-542 and 546-549. On request, the Ergo-Lock 4.0 is also available keyed alike or as an electronic PIN code or RFID lock.



Simply press to lock



Recessed handle lock, easy to use even with gloves



Electronic PIN code lock

- Operation with 2 x standard AA alkaline batteries, approx. 3 years service life / 30,000 operations
- PIN code lock with selectable user and master code
- Immediately programmable and ready for operation

Item no.
06.8900.750



Electronic RFID transponder lock

- Operation with 2 x standard AA alkaline batteries, approx. 3 years life / 30,000 operations
- RFID lock with programmable user and master cards as well as service card
- Basic programming set required for commissioning

Item no.
06.8900.740



Mechanical lock

- Mechanical key lock
- Surcharge per lock

Item no.
06.8900.7211

Basic programming set

- Master card, update card, service card
- Required for commissioning the RFID lock

Item no.
06.8900.7491

RFID user card

- One card required per user

Item no.
06.8900.7492



Open fronted storage bin cabinets

Large cabinets

- Long-lasting steel construction with a wide range of different dimensions and box fittings for every purpose
- Door reinforcements for high door stability
- High flexibility of the internal arrangement through adjustability on a 15 mm grid
- Open fronted storage bins of various sizes, colours and fittings
- 3-bolt Ergo-Lock 4.0 with 2 keys and patented mechanism: Simply press to lock!
- Drawers with telescopic rail guide, full pull-out 100%, 50 kg load capacity per drawer
- High load capacity per galvanised shelf up to 70 kg (shortened shelves up to 50 kg)

Open fronted storage bins (W x D x H)

Size 2: 103 x 160 x 75 mm

Size 3: 150 x 230 x 125 mm

Size 4: 210 x 350 x 145 mm

Size 6: 315 x 500 x 145 mm

Size 7: 315 x 500 x 200 mm



Simply press to lock



Door retention component with approx. 110° opening angle. For large cabinets with hinged doors the door opening angle is 180°



Drawers with telescopic rail guide, full pull-out, load capacity per drawer 50 kg



Recessed handle lock, easy to use even with gloves

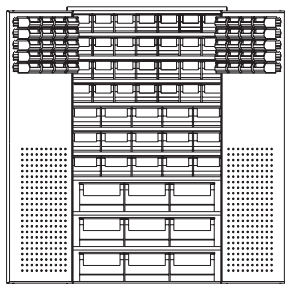

04.130276.65

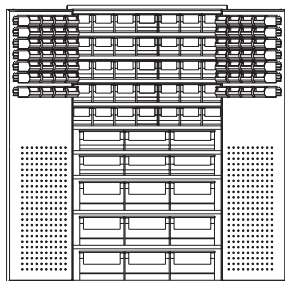

04.130276.66

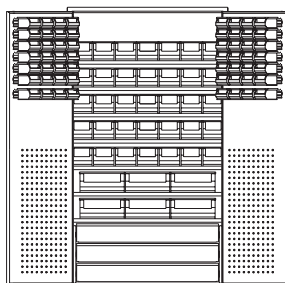

04.130276.68

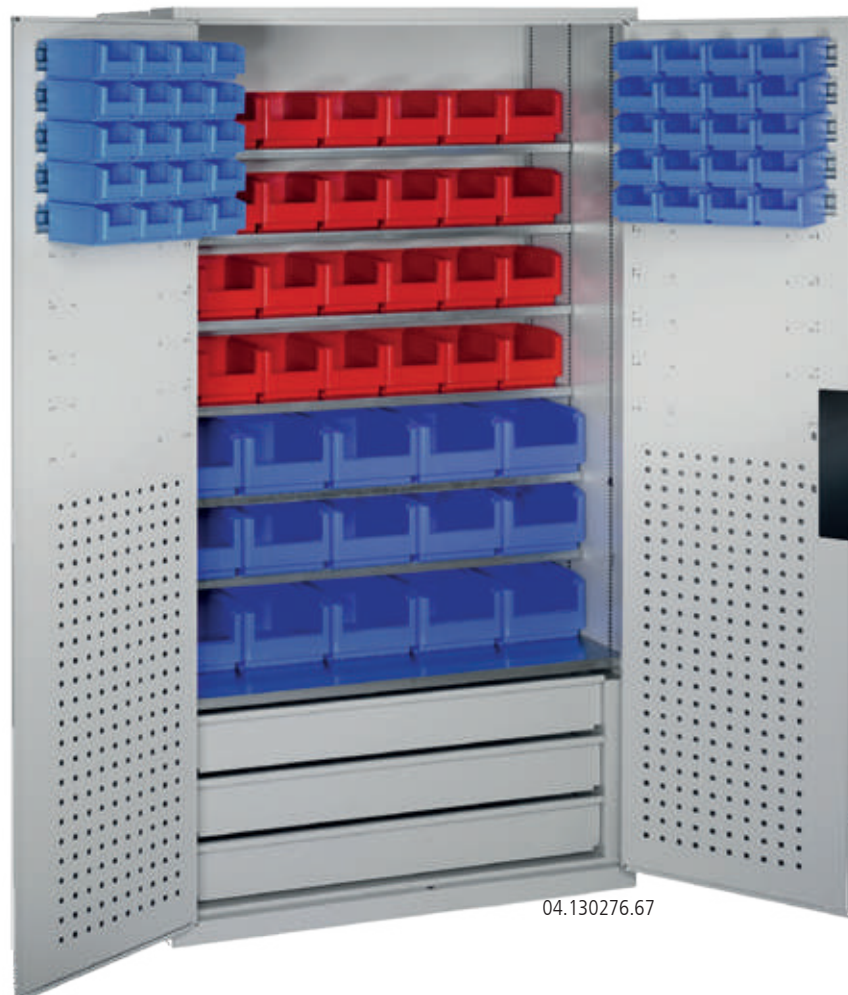

04.130276.67

Large cabinets with open fronted storage bins

- 1100 x 535 x 1950 mm (W x D x H)

Item no.	Shelves	Drawers	Rails per door	Bins
04.130276.65	9x shelf, 7x shelf, short	-	5	40x size 2 blue, 28x size 3 red, 15x size 4 blue, 9x size 7 red
04.130276.66	9x shelf, 5x shelf, short	-	7	56x size 2 red, 35x size 3 blue, 6x size 6 red, 9x size 7 blue
04.130276.67	7x shelf, 6x shelf, short	3	5	40x size 2 blue, 28x size 3 red, 15x size 4 blue
04.130276.68	7x shelf, 4x shelf, short	3	7	56x size 2 red, 35x size 3 blue, 6x size 6 red

Open fronted storage bins (W x D x H) Shelf bins (W x D x H)

Size 1: 102 x 85 x 50 mm

Size 2: 103 x 160 x 75 mm

Size 3: 150 x 230 x 125 mm

Size 4: 210 x 350 x 145 mm

Size 5: 210 x 350 x 200 mm

Size 6: 315 x 500 x 145 mm

Size 7: 315 x 500 x 200 mm

RK 3109: 117 x 300 x 90 mm

RK 3209: 234 x 300 x 90 mm

RK 3214: 234 x 300 x 140 mm



04.413.210



04.113.20



04.144.24

Cabinets with open fronted storage bins

■ 700 x 300 x 1690 mm (W x D x H)

Item no.	Shelves	Bins
04.413.20	6	-
04.413.22	9	20x size 3 red, 20x size 3 blue
04.413.23	11	36x size 2 red, 24x size 3 blue
04.413.27	13	18x size 1 red, 18x size 1 blue, 18x size 2 red, 20x size 3 blue
04.413.25	14	42x size 2 red, 48x size 2 blue
04.413.210	17	30x size 1 red, 30x size 1 blue, 24x size 2 red, 24x size 2 blue
04.413.24	9	45x size 1 red, 45x size 1 blue, 24x size 2 red, 24x size 2 blue

Additional shelf

■ galvanised

Item no.	For cabinet widths	Dimensions in mm (WxDxH)
04.013.81	700	694 x 252 x 15
04.044.81	1000	994 x 372 x 24

Cabinets with open fronted storage bins

■ 700 x 300 x 1980 mm (W x D x H)

Item no.	Shelves	Bins
04.113.20	9	-
04.113.22	15	60x size 2 red, 24x size 3 blue
04.113.23	18	60x size 2 red, 54x size 2 blue
04.113.21	11	24x size 3 red, 24x size 3 blue

Cabinets with open fronted storage bins and shelf bins

■ 1000 x 420 x 1980 mm (W x D x H)

Item no.	Shelves	Bins
04.144.20	4	-
04.144.22	6	16x size 5 red, 12x size 5 blue
04.144.23	8	24x size 4 red, 12x size 5 blue
04.144.24	9	20x size 4 red, 20x size 4 blue
04.144.29	11	48x RK 3109 blue, 112x size 4 red, 12x size 4 blue
04.144.28	12	40x RK 3109 blue, 16x RK 3209 blue, 16x RK 3214 blue

Housing

RAL 5012 | RAL 7021 | RAL 7016 | RAL 7035

Fronts

RAL 3000 | RAL 3003 | RAL 5010 | RAL 5012 | RAL 5021 | RAL 6011 | RAL 7021 | RAL 7016 | RAL 7035

Hinged door cabinets with shelves

Hinged door cabinets

- Long-lasting steel construction with a wide range of different dimensions for every purpose - up to 800 mm depth
- Central door reinforcements for high door stability
- Door retention component with approx. 110° opening angle
- High flexibility of the internal arrangement through adjustability on a 15 mm grid
- 3-bolt Ergo-Lock 4.0 with 2 keys and patented mechanism: Simply press to lock!
- High load capacity per galvanised shelf: 70 kg



Simply press to lock



Recessed handle lock, easy to use even with gloves



Door retention component with approx. 110° opening angle



04.158.120



04.155.050

04.156.093



Hinged door cabinets, height 1950 mm

- 4x galvanised shelf

Item no.	Dimensions in mm (WxDxH)	Type
04.155.050	500 x 500 x 1950	1x hinged door
04.154.070	700 x 400 x 1950	2x hinged door
04.155.070	700 x 500 x 1950	2x hinged door
04.154.093	930 x 400 x 1950	2x hinged door
04.155.093	930 x 500 x 1950	2x hinged door
04.156.093	930 x 600 x 1950	2x hinged door
04.158.093	930 x 800 x 1950	2x hinged door
04.154.120	1200 x 400 x 1950	2x hinged door
04.155.120	1200 x 500 x 1950	2x hinged door
04.156.120	1200 x 600 x 1950	2x hinged door
04.158.120	1200 x 800 x 1950	2x hinged door

Additional shelf

- Load capacity 70 kg
- galvanised

Item no.	Dimensions in mm (WxD)
04.155.050FB	495 x 453
04.154.070FB	695 x 353
04.155.070FB	695 x 453
04.154.093FB	925 x 353
04.155.093FB	925 x 453
04.156.093FB	925 x 553
04.158.093FB	925 x 753
04.154.120FB	1195 x 353
04.155.120FB	1195 x 453
04.156.120FB	1195 x 553
04.158.120FB	1195 x 753



Environment protection cabinets with two hinged doors

- Storage of small containers of water-hazardous materials, e.g. fertilizer, oils, fats, small quantities of thinner, etc.
- Hinged doors with perforated rosettes for ventilation
- Exterior height 1950 mm (interior 1840 mm)
- Internal dimensions (WxD) 928 x 453 mm
- Trays tested in accordance with the WHG (Water Resources Act)

04.01.119

plastic tray made of polyethylene



Item no.	Dimensions in mm (WxDxH)	Description
04.01.119	930 x 500 x 1950	4x adjustable galvanised tray, collection volume per tray approx. 20 l
04.01.219	930 x 500 x 1950	3x adjustable galvanised shelf, 4x plastic tray made of polyethylene

Fireproof cabinets

- Double-walled on all sides (between the walls are 25 mm thick special insulating panels, class A1 non-flammable according to DIN 4102)
- Protection against small fires and attempts at burglary
- Hinged doors on stable pintles at top and bottom
- Improved security against burglary through stable door locking mechanisms that engage in the side walls on left and right
- 5-bar bolt lock mechanism (3x side, 1x top/bottom)
- Double-bit security lock with 2 keys
- Load capacity per shelf: 70 kg

- 1x door, internal, 4x adjustable shelf

Item no.	External dimensions in mm (WxDxH)	Internal dimensions in mm (WxD)
04.112.04	650 x 500 x 1950	598 x 429

- 2x door, internal, 4x adjustable shelf

Item no.	External dimensions in mm (WxDxH)	Internal dimensions in mm (WxD)
04.112.05	930 x 500 x 1950	878 x 429

- 2x door, internal, 4x adjustable shelf

Item no.	External dimensions in mm (WxDxH)	Internal dimensions in mm (WxD)
04.112.06	1200 x 500 x 1950	1148 x 429



04.112.04

Housing

RAL 5012 | RAL 7021 | RAL 7016 | RAL 7035

Fronts

RAL 3000 | RAL 3003 | RAL 5010 | RAL 5012 | RAL 5021 | RAL 6011 | RAL 7021 | RAL 7016 | RAL 7035

Hinged door cabinets with shelves

Hinged door cabinets

New

Version:

- On enclosed plinth
- Cabinet bottom smooth, without protruding edges, therefore easy to clean
- High-quality, environmentally friendly powder coating

Interior:

- 4 x shelf, height adjustable in a grid of 50 mm
- No accessories for height adjustment necessary
- 80 kg load capacity per shelf

Doors:

- 2 x hinge each side
- Box-shaped reinforcement profile over the entire door height, for additional stabilisation
- Concealed locking bars
- Doors smooth on the outside

Locking:

- 3-point lock, recessed turning handle and integrated security cylinder lock
- Incl. 2 x key
- Doors can be locked together in the middle



04.Z13.18.150



04.Z13.14.060

Hinged door cabinets, depth 300 mm

Item no.	Dimensions in mm (WxDxH)	Type
04.Z13.13.050	500 x 300 x 1950	2x hinged door
04.Z13.13.060	600 x 300 x 1950	2x hinged door
04.Z13.13.070	700 x 300 x 1950	2x hinged door
04.Z13.13.080	800 x 300 x 1950	2x hinged door
04.Z13.13.090	900 x 300 x 1950	2x hinged door
04.Z13.13.100	1000 x 300 x 1950	2x hinged door
04.Z13.13.120	1200 x 300 x 1950	2x hinged door
04.Z13.13.150	1500 x 300 x 1950	2x hinged door

Hinged door cabinets, depth 400 mm

Item no.	Dimensions in mm (WxDxH)	Type
04.Z13.14.050	500 x 400 x 1950	2x hinged door
04.Z13.14.060	600 x 400 x 1950	2x hinged door
04.Z13.14.070	700 x 400 x 1950	2x hinged door
04.Z13.14.080	800 x 400 x 1950	2x hinged door
04.Z13.14.090	900 x 400 x 1950	2x hinged door
04.Z13.14.100	1000 x 400 x 1950	2x hinged door
04.Z13.14.120	1200 x 400 x 1950	2x hinged door
04.Z13.14.150	1500 x 400 x 1950	2x hinged door

Hinged door cabinets, depth 700 mm

Item no.	Dimensions in mm (WxDxH)	Type
04.Z13.17.050	500 x 700 x 1950	2x hinged door
04.Z13.17.060	600 x 700 x 1950	2x hinged door
04.Z13.17.070	700 x 700 x 1950	2x hinged door
04.Z13.17.080	800 x 700 x 1950	2x hinged door
04.Z13.17.090	900 x 700 x 1950	2x hinged door
04.Z13.17.100	1000 x 700 x 1950	2x hinged door
04.Z13.17.120	1200 x 700 x 1950	2x hinged door
04.Z13.17.150	1500 x 700 x 1950	2x hinged door

Hinged door cabinets, depth 800 mm

Item no.	Dimensions in mm (WxDxH)	Type
04.Z13.18.050	500 x 800 x 1950	2x hinged door
04.Z13.18.060	600 x 800 x 1950	2x hinged door
04.Z13.18.070	700 x 800 x 1950	2x hinged door
04.Z13.18.080	800 x 800 x 1950	2x hinged door
04.Z13.18.090	900 x 800 x 1950	2x hinged door
04.Z13.18.100	1000 x 800 x 1950	2x hinged door
04.Z13.18.120	1200 x 800 x 1950	2x hinged door
04.Z13.18.150	1500 x 800 x 1950	2x hinged door

Cleaning cabinets

New

Hinged and sliding door cabinets

Version:

- On enclosed plinth
- Cabinet bottom smooth, without protruding edges, therefore easy to clean
- High-quality, environmentally friendly powder coating

Interior:

- 80 kg load capacity per shelf

**Doors:**

- 2 x hinge each side
- Box-shaped reinforcement profile over the entire door height, for additional stabilisation
- Concealed locking bars

Locking:

- 3-point lock, recessed turning handle and integrated security cylinder lock
- Incl. 2 x key
- Doors can be locked together in the middle

- 2 x separate safe deposit boxed
- 3 x shelf

Item no.	Dimensions in mm (WxDxH)	Type
04.W13.14.090	900 x 400 x 1950	2x hinged door
04.W13.15.090	900 x 500 x 1950	2x hinged door
04.W13.16.090	900 x 600 x 1950	2x hinged door
04.W13.14.100	1000 x 400 x 1950	2x hinged door
04.W13.15.100	1000 x 500 x 1950	2x hinged door
04.W13.16.100	1000 x 600 x 1950	2x hinged door

- Left: 4x shelf
- Right: Hat shelf and clothes rail with 3x sliding hook

Item no.	Dimensions in mm (WxDxH)	Type
04.K13.14.090	900 x 400 x 1950	2x hinged door
04.K13.15.090	900 x 500 x 1950	2x hinged door
04.K13.16.090	900 x 600 x 1950	2x hinged door
04.K13.14.100	1000 x 400 x 1950	2x hinged door
04.K13.15.100	1000 x 500 x 1950	2x hinged door
04.K13.16.100	1000 x 600 x 1950	2x hinged door

- 1x hat shelf
- 1x clothes rail
- 1x shelf

Item no.	Dimensions in mm (WxDxH)	Type
04.V13.14.090	900 x 400 x 1950	2x hinged door
04.V13.15.090	900 x 500 x 1950	2x hinged door
04.V13.16.090	900 x 600 x 1950	2x hinged door
04.V13.14.100	1000 x 400 x 1950	2x hinged door
04.V13.15.100	1000 x 500 x 1950	2x hinged door
04.V13.16.100	1000 x 600 x 1950	2x hinged door

RAL 3000 RAL 3003 RAL 5010 RAL 5012 RAL 5018 RAL 6011 RAL 6018 RAL 7035 RAL 7016 RAL 9005

www.bedrunka-hirth.de

+32 (0)9 232 06 78

info@awp.be

Destelbergen



Heavy-duty cabinets

Heavy-duty cabinets

Heavy-duty cabinets with hinged doors:

- Long-lasting sheet steel construction
- Door retention component through external hinges, approx. 180° opening angle
- Door reinforcement for high door stability and concealed locking bar
- High flexibility of the internal arrangement through adjustability on a 15 mm grid
- 3-bolt Ergo-Lock 4.0 with 2 keys and patented mechanism:
Simply press to lock!
- High load capacity of galvanised shelves: 110 kg
- Bay load 700 kg



Simply press to lock



Recessed handle lock, easy to use even with gloves



Door opening angle approx. 180° through external hinges



Door reinforcement for high door stability with concealed locking bars



Drawers with telescopic rail guide, full pull-out, load capacity per drawer 75 kg



Heavy-duty cabinets with hinged doors

- 4x adjustable shelf, galvanised, load capacity 110 kg

Item no.	Dimensions in mm (WxDxH)
04S155093	930 x 500 x 1950
04S156093	930 x 600 x 1950
04S158093	930 x 800 x 1950
04S155120	1200 x 500 x 1950
04S156120	1200 x 600 x 1950
04S158120	1200 x 800 x 1950



Heavy-duty cabinets with centric drawer block

- 3x drawer with full pull-out
- Load capacity 75 kg per drawer
- 3x adjustable shelf, galvanised, load capacity 110 kg

Item no.	Dimensions in mm (WxDxH)
04S155093-1	930 x 500 x 1950
04S156093-1	930 x 600 x 1950
04S155120-1	1200 x 500 x 1950
04S156120-1	1200 x 600 x 1950



Heavy-duty cabinet with sliding doors

- 4x adjustable shelf, galvanised
- Turn/push cylinder lock incl. 2 key and exchangeable cylinder
- Sliding doors with smooth-running rollers

Item no.	Dimensions in mm (WxDxH)
04S255120	1200 x 500 x 1950

Heavy-duty cabinet with sliding doors

- With centre divider
- 2 x 4 adjustable shelf, galvanised

Item no.	Dimensions in mm (WxDxH)
04S255160	1600 x 500 x 1950

Cabinets with glazed doors:

- Steel-hinged doors with firmly screwed 3 mm thick acrylic glass and concealed locking bars
- Acrylic glass can be easily replaced



Hinged door cabinets with windows

- 4x adjustable shelf, galvanised, load capacity 70 kg

Item no.	Dimensions in mm (WxDxH)
04155093G	930 x 500 x 1950
04156093G	930 x 600 x 1950
04158093G	930 x 800 x 1950
04155120G	1200 x 500 x 1950
04156120G	1200 x 600 x 1950
04158120G	1200 x 800 x 1950

Hinged door cabinets with centric drawer block and viewing window

- 3x drawer with full pull-out
- Load capacity 50 kg per drawer
- 3x adjustable shelf, galvanised, load capacity 70 kg

Item no.	Dimensions in mm (WxDxH)
04155093G-2	930 x 500 x 1950
04156093G-2	930 x 600 x 1950
04155120G-2	1200 x 500 x 1950
04156120G-2	1200 x 600 x 1950

Hinged door cabinets with lower drawer block and viewing window

- 3x drawer with full pull-out
- Load capacity 50 kg per drawer
- 4x adjustable shelf, galvanised, load capacity 70 kg

Item no.	Dimensions in mm (WxDxH)
04155093G-1	930 x 500 x 1950
04156093G-1	930 x 600 x 1950
04155120G-1	1200 x 500 x 1950
04156120G-1	1200 x 600 x 1950



Smooth-running sliding doors run with special rollers in rail guides



Ergonomic metal bow-type handle for easy use



High load capacity per shelf: 70 kg

Sliding door cabinets with viewing window

- 4x adjustable shelf, galvanised, load capacity 70 kg, 1600 mm wide versions with centre panel and 2x 4 shelves
- Turn/push cylinder lock incl. 2 key and exchangeable cylinder
- Ideal for confined spaces
- Steel sliding doors with viewing window of firmly adhered 3 mm thick acrylic glass for direct view

Item no.	Dimensions in mm (WxDxH)
04255120G	1200 x 500 x 1950
04256120G	1200 x 600 x 1950
04255160G	1600 x 500 x 1950
04256160G	1600 x 600 x 1950

Housing

RAL 5012 RAL 7021 RAL 7016 RAL 7035

Fronts

RAL 3000 RAL 3003 RAL 5010 RAL 5012 RAL 5021 RAL 6011 RAL 7021 RAL 7016 RAL 7035

Hinged door cabinets

New

Battery charging cabinets

- Sturdy steel construction with high-quality coating
- Doors on external hinges, 180° door opening angle
- Optionally with solid sheet metal doors or with viewing window made of acrylic glass, 3 mm thick, easy to replace
- 3-bolt Ergo-Lock 4.0 handle lock with 2 keys and patented mechanism
Simply press to close!
- High adjustability of the shelves: adjustable in a grid of 15 mm

The innovativ e-shelf

- Sophisticated technology for simplest use
- Concealed storage tray for power supply units and supply cables of the chargers
- More space and better organisation
- Mounting and positioning of the socket strip (firmly connected to the base)
- Perforated to allow for good airflows



- Special tray floor (e-shelf), galvanised, with 5-fold socket strip and concealed accommodation level for cables and power supply units
- Perforated rear panel for optimum ventilation, comfort version with fan
- Each cabinet incl. 3 m Schuko supply cable, 230 V

All cabinets comply:

- Low Voltage Directive 2014/35/EU
- EMC Directive 2014/30/EU
- RoHS Directive 2011/65/EU



Temperature-controlled fan and central master bar in the comfort cabinet

Accessories



Additional shelf

- Only for battery charging cabinet basic
- Only one additional shelf possible (not retrofittable), incl. allocation

Item no.

06.80E1



Rubber mat

- For application on the e-shelf
- Incl. adhesive tape

Item no.

06.703



Drawer unit

- 3 x drawers full pull-out 100%, 50 kg load capacity
- With telescopic rail

Item no.

06.5702



Foam rubber mat

- To be placed in the drawer

Item no.

06.701



Battery charging cabinet basic

- Solid sheet metal doors
- 3 x shelf, galvanized
- 1 x e-shelf, permanently installed, earthed (electric tray base with 5-fold socket strip)
- 1 x additional e-shelf possible (not retrofittable)
- Additional shelves possible

Item no.	Dimensions in (W x D x H)
06.155.05E1	930 x 500 x 1950

Akkuladeschrank Basic

- Doors with viewing window
- 3 x shelf, galvanized
- 1 x e-shelf, permanently installed, earthed (electric tray base with 5-fold socket strip)
- 1 x additional e-shelf possible (not retrofittable)
- Additional shelves possible

Item no.	Dimensions in (W x D x H)
06.155.055E1	930 x 500 x 1950



Battery charging cabinet comfort

- Solid sheet metal doors
- Incl. temperature-controlled fan
- 1 x shelf, galvanized
- 3 x e-shelf, permanently installed, earthed (electric tray base with 5-fold socket strip = 15 sockets in total)
- Central master bar with fan connection, installation contactor, circuit breaker, as well as 3 x connections for socket strips

Item no.	Dimensions in (W x D x H)
06.155.05E3	930 x 500 x 1950

Battery charging cabinet comfort

- Doors with viewing window
- Incl. temperature-controlled fan
- 1 x shelf, galvanized
- 3 x e-shelf, permanently installed, earthed (electric tray base with 5-fold socket strip = 15 sockets in total)
- Central master bar with fan connection, installation contactor, circuit breaker, as well as 3 x connections for socket strips

Item no.	Dimensions in (W x D x H)
06.155.055E3	930 x 500 x 1950

Housing

RAL 5012 | RAL 7021 | RAL 7016 | RAL 7035

Fronts

RAL 3000 | RAL 3003 | RAL 5010 | RAL 5012 | RAL 5021 | RAL 6011 | RAL 7021 | RAL 7016 | RAL 7035

Sliding door cabinets

Sliding door cabinet T736 R 24-24

- Cabinet housing: Stable welded construction in steel sheet
- Doors: Double-edged and reinforced sheet steel, easy running
- Sheet steel: reinforced, powder-coated
- With push cylinder lock



Empty housing with sliding doors

- Usable height: 850 mm

Item no.	Dimensions in mm (WxDxH)
04.200.140	1410 x 790 x 1044

Drawer T 736 R 24-24

- 600 x 600 mm (W x D) with full pull-out 100 % - load capacity 70/100 kg



Item no.	Front height	Shell height	Usable height	Load capacity
60.70.050V07	50	28	30	70 kg
60.70.075V10	75	56	58	100 kg
60.70.100V10	100	81	83	100 kg
60.70.125V10	125	81	108	100 kg
60.70.150V10	150	131	133	100 kg
60.70.175V10	175	131	158	100 kg
60.70.200V10	200	181	183	100 kg
60.70.250V10	250	181	233	100 kg
60.70.300V10	300	181	283	100 kg

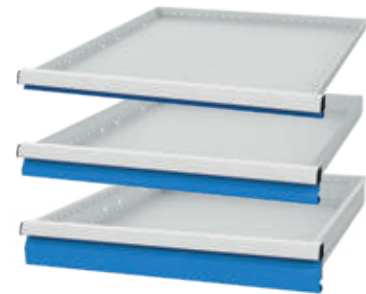

- 600 x 600 mm (W x D) with full pull-out 100 % - load capacity 180 kg



Item no.	Front height	Shell height	Usable height	Load capacity
60.70.100V18	100	81	83	180 kg
60.70.125V18	125	81	108	180 kg
60.70.150V18	150	131	133	180 kg
60.70.175V18	175	131	158	180 kg
60.70.200V18	200	181	183	180 kg
60.70.250V18	250	181	233	180 kg
60.70.300V18	300	181	283	180 kg
60.70.30V18CNC	300	81	283	180 kg
60.70.40V18CNC	400	81	383	180 kg

Shelf

Item no.	Dimensions in mm (WxDxH)	pull-out	Load capacity
04.200.92V10	600 x 615 x 55	100 %	100 kg
04.200.92V18	600 x 615 x 55	100 %	180 kg
04.200.94	647 x 670 x 25	-	100 kg



RAL standard colours, see page 27

- Push cylinder lock
- For 1200 mm width full-length shelves, for 1600 mm with centre divider
- High flexibility of the internal arrangement through adjustability on a 15 mm grid
- Load capacity shelf 70 kg



Height 1000 mm

- 2x adjustable shelf, galvanised
- Including top ribbed rubber mat

Item no.	Dimensions in mm (WxDxH)
04.254.12H10	1200 x 400 x 1000
04.255.12H10	1200 x 500 x 1000
04.256.12H10	1200 x 600 x 1000
04.254.16H10	1600 x 400 x 1000
04.255.16H10	1600 x 500 x 1000
04.256.16H10	1600 x 600 x 1000



Height 1200 mm

- 2x adjustable shelf, galvanised
- Including top ribbed rubber mat

Item no.	Dimensions in mm (WxDxH)
04.254.12H12	1200 x 400 x 1200
04.255.12H12	1200 x 500 x 1200
04.256.12H12	1200 x 600 x 1200
04.254.16H12	1600 x 400 x 1200
04.255.16H12	1600 x 500 x 1200
04.256.16H12	1600 x 600 x 1200



Height 1950 mm

- 4x galvanised shelf

Item no.	Dimensions in mm (WxDxH)
04.254.120	1200 x 400 x 1950
04.255.120	1200 x 500 x 1950
04.256.120	1200 x 600 x 1950
04.254.160	1600 x 400 x 1950
04.255.160	1600 x 500 x 1950
04.256.160	1600 x 600 x 1950



Additional shelf

- In pairs only with 1600 mm width
- Load capacity 70 kg
- galvanised

Item no.	Dimensions in mm (WxDxH)
04.254.120FB	1196 x 327 x 24
04.255.120FB	1196 x 427 x 24
04.256.120FB	1196 x 527 x 24
04.254.160FB	796 x 327 x 24
04.255.160FB	796 x 427 x 24
04.256.160FB	796 x 527 x 24

Housing

RAL 5012 | RAL 7021 | RAL 7016 | RAL 7035

Fronts

RAL 3000 | RAL 3003 | RAL 5010 | RAL 5012 | RAL 5021 | RAL 6011 | RAL 7021 | RAL 7016 | RAL 7035

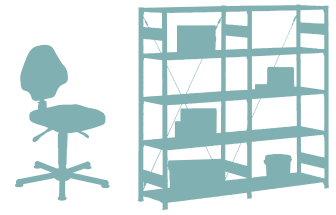

Chairs and shelving





Work stools

Page 554



New

Work chairs and standing aids

Page 556



Shelving systems

Page 564



New

Wide-span shelving

Page 568

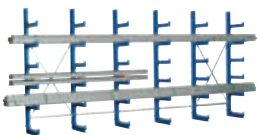

New

Cantilever shelving

Page 570



Inclined shelving

Page 574



Flow racks

Page 575



Chairs

Work stools



- PU-, Buchen- oder Polstersitz, Ø 350 m
- Concealed safety gas spring
- High-quality plastic cruciform base, Ø 630 mm

Item no.	Seat	Seat height mm
05.96.42	PU black	400 - 590, glides
05.96.43	PU black	420 - 610, casters
05.96.06	Beech	415 - 605, glides
05.96.05	Beech	435 - 625, casters
05.96.44	Padding, anthracite	475 - 665, glides
05.96.45	Padding, anthracite	495 - 685, casters



- PU-, Buchen- oder Polstersitz, Ø 350 m
- Safety gas spring
- Steel cruciform base with glides
- All-round footrest provides secure footing

Item no.	Seat	Seat height mm
05.96.39	PU black	540 - 730, glides
05.96.40	Beech	555 - 745, glides
05.96.41	Padding, anthracite	615 - 805, glides



- PU-, Buchen- oder Polstersitz, Ø 350 m
- Safety gas spring
- High-quality plastic cruciform base, black, Ø 440 mm

Item no.	Seat	Seat height mm
05.96.36	PU black	440 - 630, glides
05.96.37	Beech	455 - 645, glides
05.96.38	Padding, anthracite	515 - 705, glides



- PU-, Buchen- oder Polstersitz, Ø 350 mm
- Hochwertige Industrie-Lenkrollen
- Plastic-cruciform base with 5-compartment storage tray

Item no.	Seat	Seat height mm
05.96.12	PU black	400 - 525, casters
05.96.13	Beech	410 - 545, casters



- PU seat black
- Plastic-cruciform base black with concealed safety gas spring, black
- 7° seat incline adjustment
- The elevated backrest ensures upright sitting.

Item no.	Seat height in mm	Type
05.3571.08	415-605	Glides
05.3571.18	445-635	Casters



- PU seat black
- Plastic-cruciform base black with concealed safety gas spring, black
- 7° seat incline adjustment
- The elevated backrest ensures upright sitting.

Item no.	Seat height in mm	Type
05.3576.08	550 - 805	Glides
05.3575.08	550-805	Glides with foot ring



05.3250.04

05.3250.02

Standard stacking stool

- Quickly to hand and stacked to save space
- Seat: durable PU foam or beech plywood
- Stable steel tube frame
- Seat height 500 mm
- Seat Ø 350 mm
- Also available in stainless steel

Item no.	Seat	Frame
05.3250.01	PU black	Black
05.3250.02	Beech	Black
05.3250.04	PU black	Light grey
05.3250.22	Beech	Light grey



05.3258.01

05.3258.22

High stacking stool

- Quickly to hand and stacked to save space
- Seat: durable PU foam or beech plywood
- Stable steel tube frame
- Seat height 580 mm
- Seat Ø 350 mm
- Also available in stainless steel

Item no.	Seat	Frame
05.3258.01	PU black	Black
05.3258.02	Beech	Black
05.3258.04	PU black	Light grey
05.3258.22	Beech	Light grey



Chair

Work chairs - load capacity up to approx. 120 kg



Industrial swivel chair with foot ring and glides

- Seat and backrest of beech plywood, natural finish
- Height adjustment with gas spring
- Plastic cruciform base with glides

Item no.	Height adjustment in mm
05.94.36	590 - 840



ESD conductive chairs also available on page 453

Industrial swivel chair with casters

- Seat and backrest of beech plywood, natural finish
- Height adjustment with gas spring
- Plastic cruciform base with casters

Item no.	Height adjustment in mm
05.94.37	480 - 620



Industrial swivel chair with footrest and glides

- Seat and backrest of beech plywood, natural finish
- Height adjustment with keyway
- Steel cruciform base made of rectangular tube with glides

Item no.	Height adjustment in mm
05.94.40	640 - 880



05.94.41



05.94.42

Industrial swivel chair in two different versions

- Seat and backrest of beech plywood, natural finish
- Height adjustment with keyway
- Steel cruciform base made of rectangular tube with glides

Item no.	Height adjustment in mm	Type
05.94.41	640 - 880	with foot ring and glides
05.94.42	440 - 630	with glides

**Industrial swivel chair with footrest and glides**

- Seat and backrest PU foam, black
- Height adjustment with gas spring
- Plastic cruciform base with glides

Item no.	Height adjustment in mm
05.94.38	590 - 850

**Industrial swivel chair with glides**

- Seat and backrest PU foam, black
- Height adjustment with gas spring
- Plastic cruciform base with glides

Item no.	Height adjustment in mm
05.94.39	470 - 610

**Industrial swivel chair with foot ring and glides**

- Seat and backrest with synthetic leather upholstery, black
- Height adjustment with keyway
- Steel cruciform base made of rectangular tube with glides

Item no.	Height adjustment in mm
05.94.43	690 - 930

**Industrial swivel chair with casters**

- Seat and backrest with synthetic leather upholstery, black
- Height adjustment with keyway
- Steel cruciform base made of rectangular tube with casters

Item no.	Height adjustment in mm
05.94.44	540 - 660



Chair

Work chairs



- Very sturdy tubular steel base with three PU footrests of different heights
- Safety gas spring
- Tilting backrest
- Height-adjustable
- Backrest with adjustable incline

Item no.	Seat and backrest	Seat height mm
05.96.19	PU black	480 - 870, glides
05.96.20	Beech	460 - 850, glides
05.96.21	Padding, anthracite	490 - 880, glides



ESD
ESD conductive chairs also available on page 453



- Large PU and upholstered seat and backrest
- Ergonomically shaped
- 12° seat incline adjustment
- Asynchronous mechanism for infinite setting of the seat and backrest angle
- Safety gas spring, chrome-plated foot ring
- Plastic cruciform base

Item no.	Seat and backrest	Seat height mm
05.96.22	PU black	515 - 700, glides
05.96.23	Padding, anthracite	525 - 710, glides



- High-quality plastic cruciform base
- Safety gas spring
- PU parts with steel inserts
- Tilting backrest
- Height-adjustable
- Backrest with adjustable incline

Item no.	Seat and backrest	Seat height mm
05.96.02	PU black	435 - 625, glides
05.96.01	PU black	465 - 655, casters
05.96.04	Beech	415 - 605, glides
05.96.03	Beech	445 - 635, casters
05.96.17	Padding, anthracite	450 - 640, glides
05.96.18	Padding, anthracite	480 - 670, casters



- Stable plastic-cruciform base, black
- PU parts with steel inserts
- Tilting backrest
- Height-adjustable
- Backrest with adjustable incline

Item no.	Seat and backrest	Seat height mm
05.96.24	PU black	560 - 820, glides
05.96.25	Beech	540 - 800, glides
05.96.26	Padding, anthracite	575 - 835, glides

Work chairs



Industrial swivel chair

- Maximum load of up to 150 kg or 170 kg
- Seat and backrest with adjustable incline, back with anti-shock
- Height-adjustable with gas spring
- Steel cruciform base

Item no.	Type	Height adjustment in mm	Load capacity kg	Seat (WxD in mm)	Backrest in mm
05.95.03	With glides	490 - 630	up to 170	480 x 470	430 x 420
05.95.04	With braked casters	480 - 610	up to 170	480 x 470	430 x 420
05.95.05	Glides with footrest	590 - 840	up to 150	480 x 470	430 x 420
05.95.06	Glides with foot ring	590 - 840	up to 150	480 x 470	430 x 420

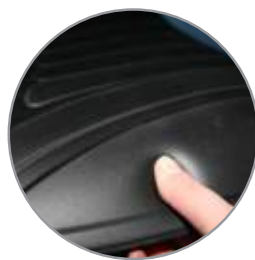

Super-soft work chair

- PU seat black
- Super-soft seat and backrest thanks to new foam system
- Shock-resistant and watertight, easy to care for and durable
- Adaptation to body shape and comfortable pressure relief thanks to ergonomically shaped seat and backrest padding.
- Ventilation channels ensure air exchange
- Stable black plastic cruciform base with concealed safety gas spring, either with load-dependent braked casters or large glides
- Height-adjustable, tilting backrest,
- Backrest with adjustable incline, permanent contact optional

Item no.	Seat height in mm	Type
05.7540.01	440 - 630	Glides
05.7540.11	460 - 650	Double casters
05.7545.01	530 - 790	Glides with foot ring

Also available with seat tilt on request (extra charge)



Chairs

Work chairs



- Seat and backrest PU foam, black
- Back with anti-shock, height and tilt adjustable
- Height adjustment with gas spring
- Elegant, stable cruciform base made of round tube, with casters

Item no.	Height adjustment in mm
05.94.31	480 - 610



- Seat and backrest PU foam, black
- Back with anti-shock, height and tilt adjustable
- Height adjustment with gas spring
- Elegant, stable cruciform base made of round tube, with floor glides

Item no.	Height adjustment in mm
05.93.32	480 - 620



- ESD version
- Seat and backrest upholstered in fabric, black
- Tilting backrest, adjustable height and incline
- Height adjustment with gas spring
- Elegant aluminium cruciform base, with casters

Item no.	Height adjustment in mm
05.94.33	510 - 650



- ESD version
- Seat and backrest PU foam, black
- Tilting backrest, adjustable height and incline
- Height adjustment with gas spring
- Elegant aluminium cruciform base, with casters

Item no.	Height adjustment in mm
05.94.34	490 - 630



- ESD version
- Seat and backrest upholstered in fabric, black
- Tilting backrest, adjustable height and incline
- Height adjustment with gas spring
- Elegant aluminium cruciform base, with floor glides

Item no.	Height adjustment in mm
05.93.35	490 - 630



 ESD
ESD conductive chairs also available on page 453



EFS footrest – adjustable incline

- Foot plate: Made of plastic with nubs, non-slip movement, adjustable height and incline
- Incline adjustment: 0 - 30°
- Height adjustment: With gas spring, activated at the press of a button
- Adjustment range: 110 - 320 mm

- Seat made of PU, non-rotating
- Depth spring action
- Gas spring height adjustment
- Black, with glides

DIN 68877

Garantie 5 Jahre auf Metall

Mobelnorm DIN 66084 P-b und P-c

Item no.	Plate in mm	Frame in mm
05.95.01	510 x 350	500 x 360

Item no.	Height adjustment in mm
05.95.02	630 - 840



kg 200



kg 110



kg 100

- Seat and backrest with synthetic leather upholstery, black
- Foldable seat, height-adjustable
- Height adjustment with handwheel adjustment
- Steel frame made of rectangular tube, with glides and small casters for easy transport
- Foldable footrest with glides, height-adjustable, rotating pedals for individual foot position

- Standing aid with ergonomically shaped PU-comfortable seat
- Easy to care for integral foam
- 15° tilting seat, 4 detent positions
- Horizontal swivelling 16° in each direction
- Seat height 600 - 850 mm, 8 detent positions

- Standing aid seat made of easy to care for PU foam, black
- Foldable
- Lockable seat height adjustment 650 - 850 mm, 10 detent positions

Item no.	Height adjustment in mm
05.94.30	550 - 770

Item no.	Frame
05.96.08	Black
05.96.27	Red
05.96.28	Light grey
05.96.30	Stainless steel

Item no.	Frame
05.96.07	Black

Chair

Standing aids

New



- Large PU seat, blue, 370 mm wide
- Seat height adjustment, 7.5° forwards and backwards
- Seat height adjustment with gas spring
- Stable plastic-cruciform base, Ø 630 mm

Item no.	Seat height mm
05.96.10	600 - 860, glides
05.96.34	560 - 750, glides
05.96.35	490 - 680, glides, GS certificated
05.96.09	520 - 710, casters, GS certificated



05.1134.05



05.1134.07

- Seat PU foam or synthetic leather
- Swivels in all directions
- Height adjustment with gas spring, 510-700 mm
- Plastic foot Ø 400 mm with soft elastomer sole

Item no.	Seat
05.1134.05	PU foam
05.1134.07	Synthetic leather



- Tilting Seat 7°, PU foam
- Swivels in all directions
- Height adjustment with gas spring, 490-680mm
- Plastic foot Ø 400 mm with soft elastomer sole

Item no.	Seat
05.11134.08	PU



- Ergonomic seat with synthetic leather in two different colours
- Swivels in all directions
- Height adjustment with gas spring, 510-700mm
- Plastic foot Ø 400 mm with soft elastomer sole

Item no.	Seat
05.11134.0-08	Atoll blue
05.11134.0-10	Black

New



kg
150

- Seat PU foam, 420 mm wide
- 12° seat incline adjustment
- With handle on the back and integrated transport wheels
- Torsion-proof safety gas spring
- Seat height 700-800 mm
- Polished aluminium frame

Item no.	Frame
05.1000.01	Without footrest
05.1075.01	With footrest



kg
110

- Seat PU foam, black
- 12° seat incline adjustment
- With handle on the back and integrated transport wheels
- Torsion-proof safety gas spring
- Seat height 700-800 mm
- Polished aluminium frame

Item no.	Frame
05.1100.01	Without footrest
05.1175.01	With footrest



kg
110

- Ergonomic seat made of PU foam with recessed grip on the back
- 7° seat incline adjustment
- Height adjustment via safety gas spring
- Seat height 580-840 mm
- Sturdy plastic cruciform base, Ø 630 mm

Item no.	Frame
05.4765.01	Without foot ring
05.4775.01	With foot ring



kg
110

- Ergonomic seat made of PU foam with recessed grip on the back
- 7° seat incline adjustment
- Height adjustment via safety gas spring
- Seat height 550-800 mm
- Aluminium cruciform base, Ø 610 mm

Item no.	Frame
05.4765.01AL	Without foot ring
05.4775.01AL	With foot ring



kg
110

- Ergonomic seat made of PU foam with carrying handle
- 12° seat incline adjustment
- Height adjustment via safety gas spring
- Seat height 570-820 mm
- Sturdy plastic cruciform base, Ø 630 mm

Item no.	Frame
05.4665.01	Without foot ring
05.4675.01	With foot ring



kg
110

- Ergonomic seat made of PU foam with carrying handle
- 12° seat incline adjustment
- Height adjustment via safety gas spring
- Seat height 530-780mm
- Aluminium cruciform base, Ø 610 mm

Item no.	Frame
05.4665.01AL	Without foot ring
05.4675.01AL	With foot ring



Shelving systems

Multi-purpose shelving

The superb all-rounder is noted for shelf loads up to 250 kg, bay loads of up to 2000 kg and robust panel shelf levels for bay widths of up to 1695 mm. Locking bars as well as shelving levels made from stepped bars and inset shelf/panel mean no additional stiffening is necessary. Easy, quick and safe assembly is guaranteed.

- With pre-assembled frame
- Additional shelf load 250 kg
- Galvanised surface



Multi-purpose shelving

- 5 levels

	Item no.	Dimensions in mm (WxDxH)		Item no.
Base shelving	05.50508.30	875 x 300 x 2000	Add-on shelving	05.50509.30
	05.50508.40	875 x 400 x 2000		05.50509.40
	05.50508.50	875 x 500 x 2000		05.50509.50
	05.50508.60	875 x 600 x 2000		05.50509.60

Multi-purpose shelving

- 5 levels

	Item no.	Dimensions in mm (WxDxH)		Item no.
Base shelving	05.50510.30	1005 x 300 x 2000	Add-on shelving	05.50511.30
	05.50510.40	1005 x 400 x 2000		05.50511.40
	05.50510.50	1005 x 500 x 2000		05.50511.50
	05.50510.60	1005 x 600 x 2000		05.50511.60

Multi-purpose shelving

- 5 levels

	Item no.	Dimensions in mm (WxDxH)		Item no.
Base shelving	05.50512.30	1285 x 300 x 2000	Add-on shelving	05.50513.30
	05.50512.40	1285 x 400 x 2000		05.50513.40
	05.50512.50	1285 x 500 x 2000		05.50513.50
	05.50512.60	1285 x 600 x 2000		05.50513.60

Multi-purpose shelving

- 5 levels

	Item no.	Dimensions in mm (WxDxH)		Item no.
Base shelving	05.50516.30	1695 x 300 x 2000	Add-on shelving	05.50517.30
	05.50516.40	1695 x 400 x 2000		05.50517.40
	05.50516.50	1695 x 500 x 2000		05.50517.50
	05.50516.60	1695 x 600 x 2000		05.50517.60



Wooden panel

Item no.	Dimensions in mm
05.18083	875 x 300
05.18084	875 x 400
05.18085	875 x 500
05.18086	875 x 600
05.18103	1005 x 300
05.18104	1005 x 400
05.18105	1005 x 500
05.18106	1005 x 600
05.18123	1285 x 300
05.18124	1285 x 400
05.18125	1285 x 500
05.18126	1285 x 600
05.18163	1695 x 300
05.18164	1695 x 400
05.18165	1695 x 500
05.18166	1695 x 600

single-sided

- Base and add-on shelving
- 60 kg load capacity per shelf
- Simple push-fit assembly
- Galvanised surface
- Shelving with rear stop edge
- Height-adjustability 25 : 25 mm
- External dimensions:
 - Width base shelving 810 or 1060 mm
 - Width add-on shelving 760 or 1010 mm
 - Nominal dimension depth + 35 mm
- Additional shelves on request

Security:

Shelving with a height/depth ratio greater than 5:1 must be secured to prevent it from tipping DGUV rule 108-007

Example:

3000 mm (H): 435 mm (D) = 6.9

The shelf must be secured!

2000 mm (H): 535 mm (D) = 3.74

The shelf does not need to be secured

Tilt protection see page 566



Document shelving, single-sided

	Item no.	Dimensions in mm (WxDxH)	Folder capacity	Shelves		Item no.
Base shelving	05.HZG17307EX	750 x 300 x 1750	45 pcs.	5	Add-on shelving	05.HZA17307EX
	05.HZG17310EX	1000 x 300 x 1750	60 pcs.	5		05.HZA17310EX
	05.HZG20307EX	750 x 300 x 2000	54 pcs.	6		05.HZA20307EX
	05.HZG20310EX	1000 x 300 x 2000	72 pcs.	6		05.HZA20310EX
	05.HZG23307EX	750 x 300 x 2350	63 pcs.	7		05.HZA23307EX
	05.HZG23310EX	1000 x 300 x 2350	84 pcs.	7		05.HZA23310EX
	05.HZG27307EX	750 x 300 x 2700	72 pcs.	8		05.HZA27307EX
	05.HZG27310EX	1000 x 300 x 2700	96 pcs.	8		05.HZA27310EX

Double-sided

- Base and add-on shelving
- 90 kg load capacity per shelf
- Simple push-fit assembly
- Galvanised surface
- Shelving with central stopper
- Height-adjustability 25 : 25 mm
- External dimensions:
 - Width base shelving 810 or 1060 mm
 - Width add-on shelving 760 or 1010 mm
 - Nominal dimension depth + 35 mm
- Additional shelves on request



Document shelving, double-sided

	Item no.	Dimensions in mm (WxDxH)	Folder capacity	Shelves		Item no.
Base shelving	05.HZG17607DA	750 x 600 x 1750	90 pcs.	5	Add-on shelving	05.HZA17607DA
	05.HZG17610DA	1000 x 600 x 1750	120 pcs.	5		05.HZA17610DA
	05.HZG20607DA	750 x 600 x 2000	108 pcs.	6		05.HZA20607DA
	05.HZG20610DA	1000 x 600 x 2000	144 pcs.	6		05.HZA20610DA
	05.HZG23607DA	750 x 600 x 2350	126 pcs.	7		05.HZA23607DA
	05.HZG23610DA	1000 x 600 x 2350	168 pcs.	7		05.HZA23610DA
	05.HZG27607DA	750 x 600 x 2700	144 pcs.	8		05.HZA27607DA
	05.HZG27610DA	1000 x 600 x 2700	192 pcs.	8		05.HZA27610DA



Shelving systems

Shelving racks

- Base and add-on shelving with shelves
- 200 - 240 kg load capacity per shelf
- Simple push-fit assembly
- Galvanised surface
- 40 mm folded shelf edge
- Height-adjustability 25 : 25 mm
- External dimensions:
 - Width base shelving 1060/1360 mm
 - Width add-on shelving 1010/1310 mm
 - Nominal dimension depth + 35 mm
- Other versions on request.

Security:

Shelving with a height/depth ratio greater than 5:1 must be secured to prevent it from tipping DGUV rule 108-007

Example:

3000 mm (H): 435 mm (D) = 6.9

The shelf must be secured!

2000 mm (H): 535 mm (D) = 3.74

The shelf does not need to be secured

Tilt protection

Necessary if a height-depth ratio of 5:1 is exceeded



Item no.	Type
05.ZW46	Ceiling anchoring
05.ZW45	Wall anchoring

Shelving rack height 2000 mm

	Item no.	Dimensions in mm (WxDxH)	Shelves		Item no.
Base shelving	05.HZG20410XM	1000 x 400 x 2000	5	Add-on shelving	05.HZA20410XM
	05.HZG20510XM	1000 x 500 x 2000	5		05.HZA20510XM
	05.HZG20610XM	1000 x 600 x 2000	5		05.HZA20610XM
	05.HZG20413XM	1300 x 400 x 2000	5		05.HZA20413XM
	05.HZG20513XM	1300 x 500 x 2000	5		05.HZA20513XM
	05.HZG20613XM	1300 x 600 x 2000	5		05.HZA20613XM

Shelving rack height 2500 mm

	Item no.	Dimensions in mm (WxDxH)	Shelves		Item no.
Base shelving	05.HZG25410XM	1000 x 400 x 2500	6	Add-on shelving	05.HZA25410XM
	05.HZG25510XM	1000 x 500 x 2500	6		05.HZA25510XM
	05.HZG25610XM	1000 x 600 x 2500	6		05.HZA25610XM
	05.HZG25413XM	1300 x 400 x 2500	6		05.HZA25413XM
	05.HZG25513XM	1300 x 500 x 2500	6		05.HZA25513XM
	05.HZG25613XM	1300 x 600 x 2500	6		05.HZA25613XM

Shelving rack height 3000 mm

	Item no.	Dimensions in mm (WxDxH)	Shelves		Item no.
Base shelving	05.HZG30410XM	1000 x 400 x 3000	7	Add-on shelving	05.HZA30410XM
	05.HZG30510XM	1000 x 500 x 3000	7		05.HZA30510XM
	05.HZG30610XM	1000 x 600 x 3000	7		05.HZA30610XM
	05.HZG30413XM	1300 x 400 x 3000	7		05.HZA30413XM
	05.HZG30513XM	1300 x 500 x 3000	7		05.HZA30513XM
	05.HZG30613XM	1300 x 600 x 3000	7		05.HZA30613XM

Corner shelving racks

Chairs and shelving

- Corner shelving rack
- 125 kg per shelf
- Simple push-fit assembly
- Galvanised surface
- Height-adjustability 25 : 25 mm
- With diagonal bars and reinforcement cross-members
- Room corners can be fully utilised by avoiding the "dead corner"
- Recommended add-on shelving, see page 566

Security:

Shelving with a height/depth ratio greater than 5:1 must be secured to prevent it from tipping DGUV rule 108-007

Example:

3000 mm (H): 435 mm (D) = 6.9

The shelf must be secured!

2000 mm (H): 535 mm (D) = 3.74

The shelf does not need to be secured

**Tilt protection**

Necessary if a height-depth ratio of 5:1 is exceeded

Item no.	Type
05.ZW46	Ceiling anchoring
05.ZW45	Wall anchoring

Corner shelving height 2000

Item no.	Dimensions in mm (WxDxH)	Shelves
05.HZE20410AXL	1060 / 1450 x 400 x 2000	2 x 5
05.HZE20510AXL	1060 / 1550 x 500 x 2000	2 x 5
05.HZE20413AXL	1360 / 1750 x 400 x 2000	2 x 5
05.HZE20513AXL	1360 / 1850 x 500 x 2000	2 x 5

Corner shelving height 2500

Item no.	Dimensions in mm (WxDxH)	Shelves
05.HZE25410AXL	1060 / 1450 x 400 x 2500	2 x 6
05.HZE25510AXL	1060 / 1550 x 500 x 2500	2 x 6
05.HZE25413AXL	1360 / 1750 x 400 x 2500	2 x 6
05.HZE25513AXL	1360 / 1850 x 500 x 2500	2 x 6

Corner shelving height 3000

Item no.	Dimensions in mm (WxDxH)	Shelves
05.HZE30410AXL	1060 / 1450 x 400 x 3000	2 x 7
05.HZE30510AXL	1060 / 1550 x 500 x 3000	2 x 7
05.HZE30413AXL	1360 / 1750 x 400 x 3000	2 x 7
05.HZE30513AXL	1360 / 1850 x 500 x 3000	2 x 7

Shelving systems

Wide-span shelving rack

New

Compact wide-span shelving system, which represents the step between standard shelving and pallet shelving and is designed for the storage of particularly large and heavy goods. Due to its shelving dimensions, this wide-span shelving system offers large-area storage options. It can therefore be used in many different sectors.

Advantages:

- 3 shelf levels with wooden inlay chip 19 mm P4
- Height 2000mm, optional 2500mm and 3000mm
- Compact shelving system, powder-coated in RAL 5010.
- Large-area storage options
- Bay widths up to 2,700 mm
- High shelf loads up to 975 kg
- Bay load up to 7,500 kg



Wide-span shelving rack, width 1850 mm

- 3 shelf levels with wooden inlay

	Item no.	Dimensions in mm (W x D x H)		Item no.
Base shelving	05.9010260	1850 x 600 x 2000	Add-on shelving	05.9010360
	05.9010280	1850 x 800 x 2000		05.9010380
	05.90102100	1850 x 1000 x 2000		05.90103100

Wide-span shelving rack, width 2250 mm

- 3 shelf levels with wooden inlay

	Item no.	Dimensions in mm (W x D x H)		Item no.
Base shelving	05.9010460	2250 x 600 x 2000	Add-on shelving	05.9010560
	05.9010480	2250 x 800 x 2000		05.9010580
	05.90104100	2250 x 1000 x 2000		05.90105100

Wide-span shelving rack, width 2700 mm

- 3 shelf levels with wooden inlay

	Item no.	Dimensions in mm (W x D x H)		Item no.
Base shelving	05.9010660	2700 x 600 x 2000	Add-on shelving	05.9010760
	05.9010680	2700 x 800 x 2000		05.9010780
	05.90106100	2700 x 1000 x 2000		05.90107100

Additional shelf with wooden inlay

Item no.	Maße in mm (BxT)
05.90114K	1850 x 600
05.90116K	1850 x 800
05.90118K	1850 x 1000
05.90124K	2250 x 600
05.90126K	2250 x 800
05.90128K	2250 x 1000

05.90134K	2700 x 600
05.90136K	2700 x 800
05.90138K	2700 x 1000

The ideal solution for professional storage of pallets, pallet cages and heavy loads. Thanks to an optimally coordinated range of shelving components such as support frames, support beams and many other accessories, pallet shelving can be individually adapted to different stored goods and spatial conditions.

- Frame similar to RAL 7001 silver grey, support beams similar to RAL 2004 pure orange
- All specified loads apply with uniformly distributed load
- The specified buckling lengths must not be exceeded
- Further versions on request...



Pallet shelving

- 2 levels (4x support beam)
- Shelf load 2000 kg
- Bay load 4000 kg

Base shelving	Item no.	Dimensions in mm (W x D x H)	max. buckling length	Add-on shelving	Item no.	Dimensions in mm (W x D x H)
	05.721131100	2870 x 1100 x 2500	1000 mm		05.721141100	2785 x 1100 x 2500
05.722131100	2870 x 1100 x 3000	1250 mm	05.722141100	2785 x 1100 x 3000		

Pallet shelving

- 3 levels (6x support beam)
- Shelf load 2000 kg
- Bay load 6000 kg

Base shelving	Item no.	Dimensions in mm (W x D x H)	max. buckling length	Add-on shelving	Item no.	Dimensions in mm (W x D x H)
	05.733131100	2870 x 1100 x 3500	1000 mm		05.733141100	2785 x 1100 x 3500
	05.734131100	2870 x 1100 x 4000	1150 mm		05.734141100	2785 x 1100 x 4000
	05.735131100	2870 x 1100 x 4500	1300 mm		05.7351241100	2785 x 1100 x 4500
05.737131100	2870 x 1100 x 5500	1650 mm	05.737141100	2785 x 1100 x 5500		

Accessories

Description	Item no.	Dimensions in mm (W x D x H)	Load capacity in kg per pair
Wedge anchor (2 pieces need for each frame)	05.13020E		
Underlay plate, 1 mm	05.12341E		
Support beam (single) incl. locking pins	05.15012K	2700 x 50 x 110	2000
Impact protection for corners (incl. 4 floor anchors)	05.B4-40102-K	H 400	
Wire mesh cover (3 pieces)	05.12096K	BxT 2700 x 1100, Mw 50 x 100	2000
Push-through protection	05.12316K	2700 x 50 x 50	



Impact protection for corners



Wire mesh cover



Push-through protection

Shelving systems

Cantilever shelving

Technical features:

- Cantilever arms permanently welded
- Uprights and cantilever arms in IPE profiles
- Cantilever arms with permanently welded roll-off protection
- Storage levels including foot support
- Usable depth 500 mm
- Up to 200 kg load capacity per cantilever arm
- High-quality industrial coating RAL 5010

Planning notes:

- External dimensions:
 - Width base shelving 1305 mm
 - Width add-on shelving 1250 mm
 - Nominal dimension depth + 100 mm

Product advantages:

- Affordable system
- Standardised shelving components
- Quick and easy assembly
- Single or double-sided use

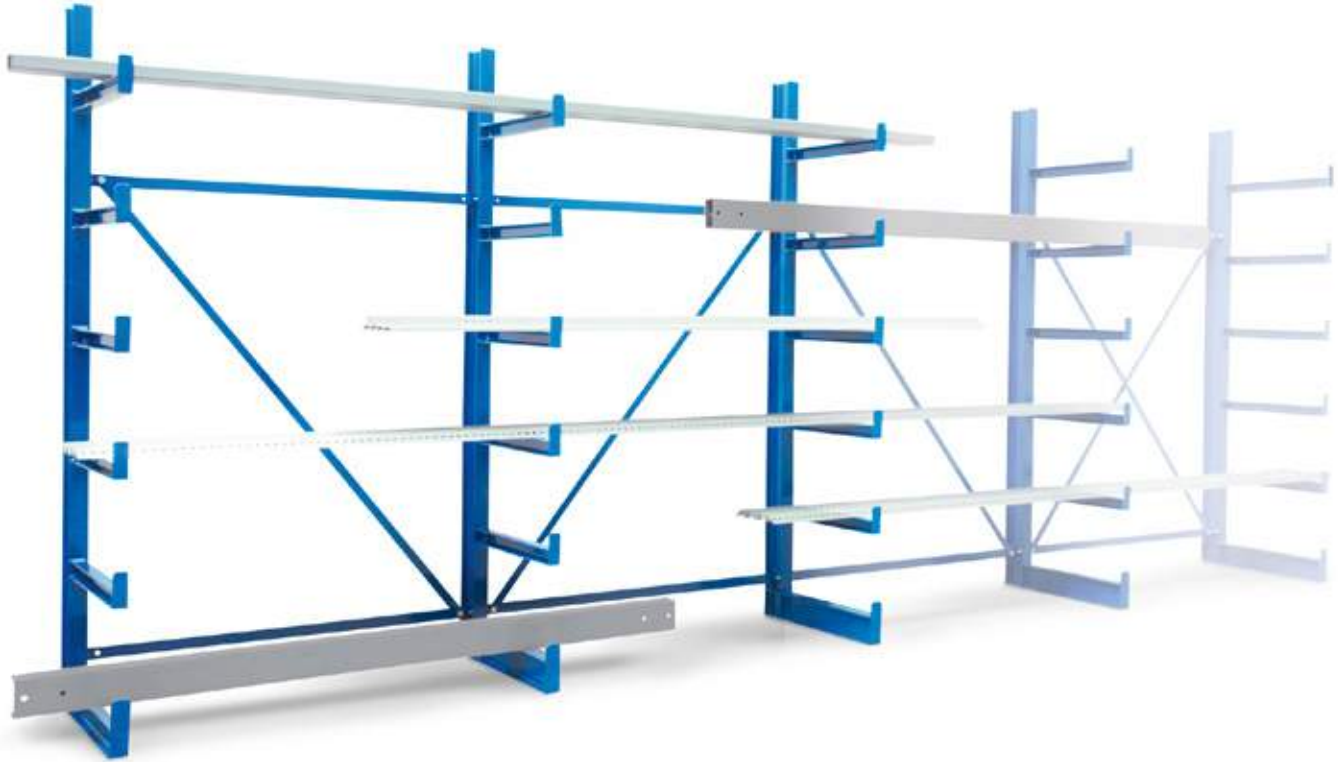

Cantilever shelving

Item no.	Description	Dimensions in mm (WxDxH)
05.60101-50	Base unit with 12 welded arms on one side, length 500 mm, with 2 diagonal bars	1250 x 500 x 2000
05.60102-50	Extension unit with 12 welded arms on one side, length 500 mm, with 1 diagonal bar	1250 x 500 x 2000
05.60121-50	Base unit with 24 welded arms on both sides, length 500 mm, with 2 diagonal bars	1250 x 1000 x 2000
05.60122-50	Extension unit with 24 welded arms on both sides, length 500 mm, with 1 diagonal bar	1250 x 1000 x 2000

Technical features:

- Cantilever arms freely adjustable on the 100 mm grid
- Uprights and cantilever arms in IPE profiles
- Cantilever arms with permanently welded roll-off protection
- Storage levels including foot support
- Usable depth 500 mm
- Up to 500 kg load capacity per cantilever arm
- High-quality industrial coating RAL 5010

Planning notes:

- External dimensions:
Width base shelving 1060 mm
Width add-on shelving 1060 mm
Nominal dimension depth + 120 mm

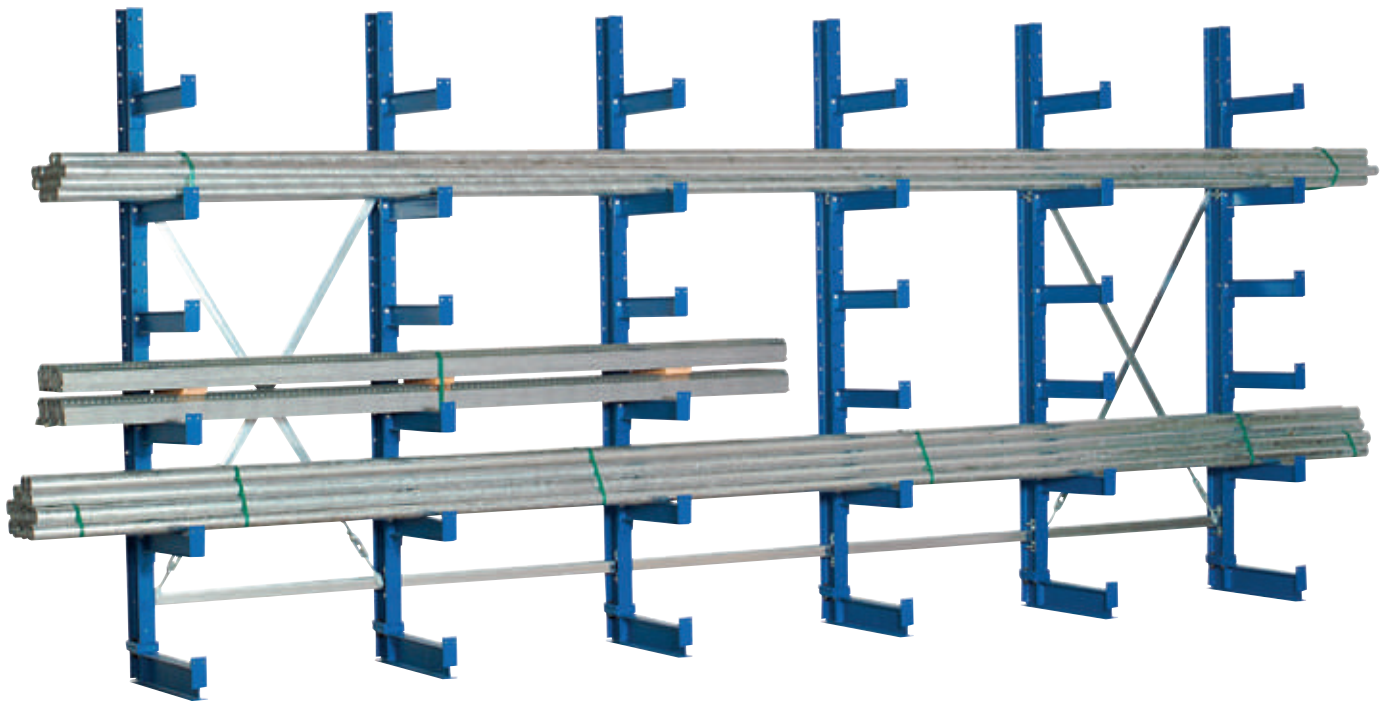
**Cantilever shelving, base shelving**

Item no.	Description	Dimensions in mm (WxDxH)
05.20101-50	One-sided with 10 adjustable arms 500 mm long, with 2 diagonal bars, bay load 2000 kg	1000 x 500 x 2000
05.20121-50	Double-sided, with 20 adjustable arms 500 mm long, with 2 diagonal bars, bay load 4000 kg	1000 x 1000 x 2000
05.20201-50	One-sided with 12 adjustable arms 500 mm long, with 2 diagonal bars, bay load 2000 kg	1000 x 500 x 2500
05.20221-50	Double-sided, with 24 adjustable arms 500 mm long, with 2 diagonal bars, bay load 4000 kg	1000 x 1000 x 2500

Cantilever shelving, add-on shelving

Item no.	Description	Dimensions in mm (WxDxH)
05.20102-50	One-sided with 10 adjustable arms 500 mm long, with 1 diagonal bar, bay load 2000 kg	1000 x 500 x 2000
05.20122-50	Double-sided, with 20 adjustable arms 500 mm long, with 1 diagonal bar, bay load 4000 kg	1000 x 1000 x 2000
05.20202-50	One-sided with 12 adjustable arms 500 mm long, with 1 diagonal bar, bay load 2000 kg	1000 x 500 x 2500
05.20222-50	Double-sided, with 24 adjustable arms 500 mm long, with 1 diagonal bar, bay load 4000 kg	1000 x 1000 x 2500

Cantilever arm, additional

Item no.	Description	Dimensions in mm (WxDxH)
05.402-K	Incl. screw fastening	500



Cantilever shelving for light loads

Technical features:

- Versatile modular system for every type of stored goods
- High-quality powder coating for indoor use
- Durable hot dip galvanised finish for outdoor use
- Cantilever shelving with roof construction as a cold hall
- Shelving systems for light to heavy loads
- Single and double sided shelving systems
- Cantilever racking with short delivery times
- Cantilever racking with roof and wall
- Further versions on request

- Load capacity one-sided shelving 1500 kg per pillar
- Load capacity double-sided shelving 1500 kg per pillar

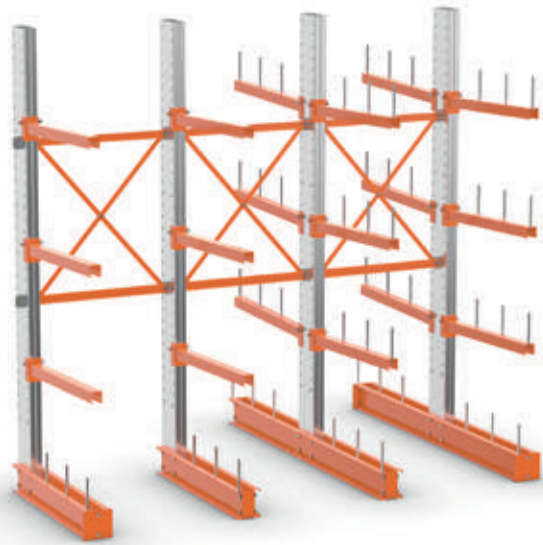

Base shelving one-sided

- For light loads, 2x pillar, 6x cantilever arm, 1x diagonal bar, 4x floor anchor, width 1180 mm

Height	1976		2432	
Usable depth in mm	500	700	500	700
Load capacity per level in kg	600	400	600	400
Load capacity in kg	3000	2000	3000	2000
Item no.	05.0A32-197	05.1A32-197	05.0A32-243	05.1A32-243

Add-on shelving one-sided

- For light loads, 1x pillar, 3x cantilever arm, 1x diagonal bar, 4x floor anchor, width 1000 mm

Height	1976		2432	
Usable depth in mm	500	700	500	700
Load capacity per level in kg	600	400	300	200
Load capacity in kg	3000	2000	1500	1000
Item no.	05.0A31-197	05.1A31-197	05.0A31-243	05.1A31-243

Base shelving double-sided

- For light loads, 2x pillar, 12x cantilever arm, 1x diagonal bar, 4x floor anchor, width 1180 mm

Height	1976		2432	
Usable depth in mm	500	700	500	700
Load capacity per level in kg	600	400	600	400
Load capacity in kg	6000	4000	6000	4000
Item no.	05.0B32-197	05.1B32-197	05.0B32-243	05.1B32-243

Add-on shelving double-sided

- For light loads, 1x pillar, 6x cantilever arm, 1x diagonal bar, 4x floor anchor, width 1000 mm

Height	1976		2432	
Usable depth in mm	500	700	500	700
Load capacity per level in kg	600	400	300	200
Load capacity in kg	3000	2000	1500	1000
Item no.	05.0B31-197	05.1B31-197	05.0B31-243	05.1B31-243

Cantilever arm

Item no.	Length in mm	Load capacity in kg
05.L11A030-050	500	300
05.L11A030-070	700	200

End stopper

Item no.	Length in mm
05.KTEM12-100	100
05.KTEM12-150	150

- Load capacity one-sided shelving 1600 kg per pillar depth 800 mm
- Load capacity one-sided shelving 1400kg per pillar depth 1000 mm
- Load capacity double-sided shelving 1600 kg per pillar depth 800 mm
- Load capacity double-sided shelving 1400kg per pillar depth 1000 mm

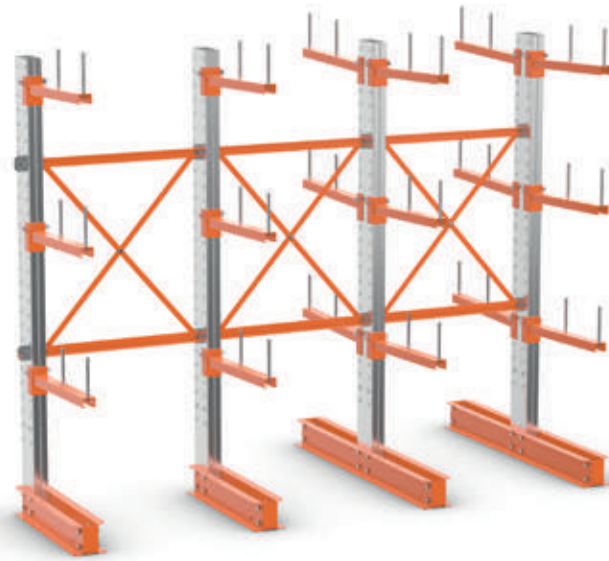

Base shelving one-sided

- For heavy loads, 2x pillar, 6x cantilever arm, 1x diagonal bar, 4x floor anchor, width 1160 mm

Height	2432		2964	
Usable depth in mm	800	1000	800	1000
Load capacity per level in kg	800	600	800	600
Load capacity in kg	3200	2800	3200	2800
Item no.	M05.0A32-243	M05.1A32-243	M05.0A32-296	M05.1A32-296

Add-on shelving one-sided

- For heavy loads, 1x pillar, 3x cantilever arm, 1x diagonal bar, 4x floor anchor, width 1000 mm

Height	2432		2964	
Usable depth in mm	800	1000	800	1000
Load capacity per level in kg	400	300	400	300
Load capacity in kg	1600	1400	3200	2800
Item no.	M05.0A31-243	M05.1A31-243	M05.0A31-296	M05.1A31-296

Base shelving double-sided

- For heavy loads, 2x pillar, 12x cantilever arm, 1x diagonal bar, 4x floor anchor, width 1180 mm

Height	2432		2964	
Usable depth in mm	800	1000	800	1000
Load capacity per level in kg	800	600	800	600
Load capacity in kg	6400	5600	6400	5600
Item no.	M05.0B32-243	M05.1B32-243	M05.0B32-296	M05.1B32-296

Add-on shelving double-sided

- For heavy loads, 1x pillar, 6x cantilever arm, 1x diagonal bar, 4x floor anchor, width 1000 mm

Height	2432		2964	
Usable depth in mm	800	1000	800	1000
Load capacity per level in kg	400	300	400	300
Load capacity in kg	3200	2800	3200	2800
Item no.	M05.0B31-243	M05.1B31-243	M05.0B31-296	M05.1B31-296

Cantilever arm

Item no.	Length in mm	Load capacity in kg
05.M11A040-080	800	400
05.M11A030-1000	1000	300

End stopper

Item no.	Length in mm
05.KTEM12-100	100
05.KTEM12-150	150

Shelving systems

Inclined shelving

- Incline angle of the inclined shelves approx. 34°
- The levels are height-adjustable in steps of 25 mm (screwless)
- Push-fit assembly
- Extendable as desired
- Level load: 100 kg
- External dimensions:
Width base shelving: 1060/1360 mm
Width add-on shelving: 1010/1310 mm
Shelf depth 600 mm, shelf depth: 535 mm
- Galvanised surface



Inclined shelving

- 3 storage levels

	Item no.	Dimensions in mm (WxDxH)		Item no.
Base shelving	05.HZG20510S	1000 x 500 x 2000	Add-on shelving	05.HZA20510S
	05.HZG20513S	1300 x 500 x 2000		05.HZA20513S

Inclined shelving additional level

Item no.	For width in mm
05.Z505100	1000
05.Z505130	1300

- Incline angle of the shelving levels approx. 3-4°
 - Screwless height-adjustment in steps of 25 mm
 - Level load: 200/400 kg
 - Galvanised surface
- External dimensions:
Width base shelving 1360 mm
Width add-on shelving 1310 mm
Shelf depth 1275/2555 mm



Flow rack

Item no.	Type	Dimensions in mm (WxDxH)	Type
05.DLR-AFKLV	Brake plate for small roller conveyor		
05.HZG201213KR	Flow rack, base shelving	1300 x 1200 x 2000	4 levels, 4 channels per level 5 guide rails per level, bay load 1000 kg Normal rollers
05.HZA201213KR	Flow rack, add-on shelving	1300 x 1200 x 2000	4 levels, 4 channels per level 5 guide rails per level, bay load 1000 kg Normal rollers
05.KR13120GE	Additional level	1300 x 1200	4 channels, 5 guide rails
05.HZG202413KR	Flow rack, base shelving	1300 x 2400 x 2000	4 levels, 4 channels per level, bay load 2000 kg Small flanged rollers, without guide rails
05.HZA202413KR	Flow rack, add-on shelving	1300 x 2400 x 2000	4 levels, 4 channels per level, bay load 2000 kg Small flanged rollers, without guide rails
05.KR13240GE	Additional level	1300 x 2400	4 channels



Shelving systems

Flow rack - movable

- Incline angle of the shelving levels approx. 3-4°
- Small roller strips and guide rails can be adjusted as required on a 6 mm grid
- Special cross-members with large rounding for protected removal of containers
- Push-fit assembly
- Swivel steering casters (wheel diameter 125 mm)
- Bay load: 700 kg
- Level load: 200 kg
- Bay depth: 1275 mm
- Width base shelving: 1360 mm
- Total height 2000 mm
- Galvanised surface

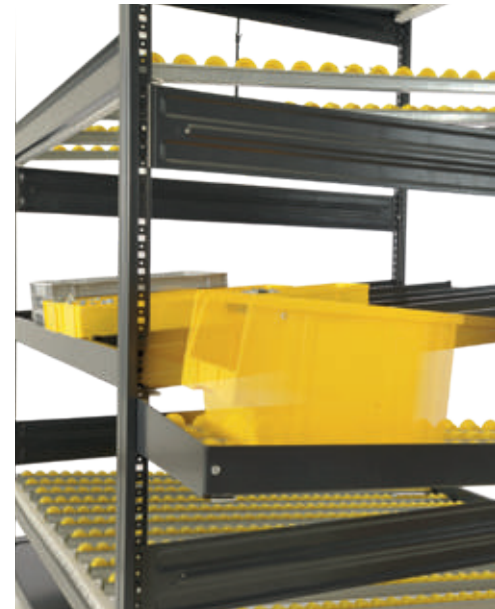
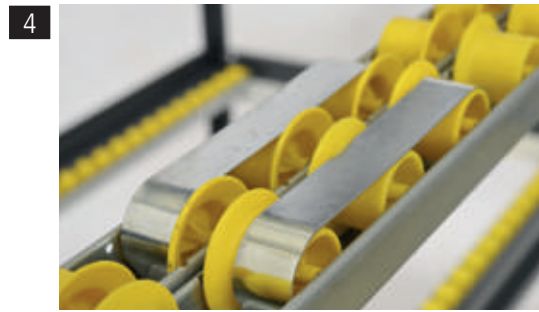

Pos.	Item no.	Product	Dimensions in mm (WxDxH)	Type
1	05.HZG171213KR	Flow rack unit, base shelving	1300 x 1200 x 1750	1 12 normal roller strips N33, without guide rails (return) 2 10 normal rollers N33 and 6 guide rails (feed) 3 6 small flanged rollers, without guide rails (feed) 4 6 normal roller strips and 4 guide rails (feed)
2	05.HZGTW1240	Shelving transport trolley	1375 x 1280 x 200	2 support frames, unassembled 2 diagonal bars with lock 2 steering casters with locks; 2 fixed casters
3	05.HZGRÜ1240	Return level	1240 x 335 (WxD)	2 normal roller strips N33 1 guide rail 2 mounting brackets 1 connecting rail
4	05.DLR-AFKLV	Brake plate		For small roller conveyor
5	05.HZGRÜ1410	Auxiliary frame	1472 x 395 (WxD)	Auxiliary frame for returning containers to workraster work bench Incline 1410 x 395 (WxD)

Supplied without decoration, hooks and bins

Flow rack in combination with work benches

Chairs and shelving

- 200 kg load capacity per level (with even load)
- Roller conveyors ensure that the goods roll automatically to the removal point - gravity principle
- Flexible and screwless level adjustment in steps of 25 mm
- Shelf is not screwed to the work bench



workraster ■ Work bench
■ Height adjustment range 735 - 1100 mm



workline ■ Work bench
■ Height adjustment range 735 - 1100 mm



workergo ■ C-foot work bench
■ Height adjustment range 695 - 1030 mm

Prices on request



Cloakroom cabinets





Benches

Page 580



Steel wardrobe lockers

Page 581



Compartment lockers

Page 585



Compartment lockers with glazed doors

Page 587



Multi-purpose cabinets

Page 588



Fire brigade cabinets

Page 589



Benches

Benches



Stackable benches

- Stable construction
- Feet made of round tube Ø 25 mm, paint RAL 7021 black grey, powder-coated
- Abrasion-resistant plastic sliding base in black
- Seat depth 300 mm, seat height 460 mm
- Seat surface made of clear varnished solid beech wood slats 80 x 20 mm
- Delivered ready-assembled

Stand-alone bench

- Stable square tube construction 30 x 30 mm, paint RAL 7021 black grey
- Seating surface made of rounded, painted hardwood slats 60 x 30 mm
- Shoe trays with 5 cross struts made of square tube
- Sliding base with 10 mm levelling
- Delivered ready-assembled



Stackable benches

Item no.	Dimensions in mm (WxDxH)	Description
06.85.50	1200 x 460 x 460	4x foot
06.85.51	1600 x 460 x 460	4x foot
06.85.52	2000 x 460 x 460	6x foot

Stand-alone bench

Item no.	Dimensions in mm (WxDxH)	Description
06.50.000	1000 x 353 x 420	4x foot, without shoe grate
06.50.010	1000 x 353 x 420	4x foot, with shoe grate
06.51.000	1500 x 353 x 420	4x foot, without shoe grate
06.51.010	1500 x 353 x 420	4x foot, with shoe grate
06.52.000	1960 x 353 x 420	6x foot, without shoe grate
06.52.010	1960 x 353 x 420	6x foot, with shoe grate

- Stable steel construction
- Doors with vertical reinforcement, hinged on the right and on pintles
- With 3 ventilation slots at the top and bottom and punched label holders
- Insertable hat shelf
- Clothes rail with 3 sliding hooks
- Rotary bolt for padlock
- Easy interior cleaning thanks to flat, sweepable compartment shelves
- Compartment width 300 mm



Increased corrosion protection for the cabinet thanks to plastic cabinet feet



Cylinder lock



06.010.F020



06.055.F030

Wardrobe lockers with 100 mm feet

Item no.	Dimensions in mm (WxDxH)	Number of compartments
06.010.F020	610 x 500 x 1950	2
06.010.F030	900 x 500 x 1950	3
06.010.F040	1190 x 500 x 1950	4

Wardrobe lockers without feet

Item no.	Dimensions in mm (WxDxH)	Number of compartments
06.055.F020	610 x 500 x 1850	2
06.055.F030	900 x 500 x 1850	3
06.055.F040	1190 x 500 x 1850	4

Housing	Fronts
RAL 7035	RAL 5023 RAL 7035



Steel wardrobe lockers

Wardrobe lockers with feet

- Long-lasting steel construction, front panels also made of steel
- Optimal ventilation in the cabinet thanks to the ventilation concept
- Doors hinged on the right, on pintles with vertical reinforcement, ventilation slots and punched label holders
- Door stop damper
- Insertable hat shelf and wardrobe rail made of oval profile with 3 twist-proof sliding hooks for each compartment
- Rotary bolt for padlock as practical basic equipment
- Feet with body colour RAL 7035 in light grey, with all other body colours in black



Oval special wardrobe rail with twist-proof double sliding hooks. Enormous load capacity and high operating comfort



Increased corrosion protection for the cabinet thanks to plastic cabinet feet



Ventilation concept

The air outlet at the back of the cabinet base ensures good ventilation and drying in the compartment. In the case of base-mounted cabinets, ventilation is provided via openings above the recessed base.



06.01.430

Wardrobe lockers with 150 mm feet

Item no.	Dimensions in mm (WxDxH)	Compartment width in mm	Compartments	Description
06.01.230	610 x 500 x 1850	300	2	Rotary bolt for padlock
06.01.231	610 x 500 x 1850	300	2	Cylinder lock
06.01.240	810 x 500 x 1850	400	2	Rotary bolt for padlock
06.01.241	810 x 500 x 1850	400	2	Cylinder lock
06.01.330	900 x 500 x 1850	300	3	Rotary bolt for padlock
06.01.331	900 x 500 x 1850	300	3	Cylinder lock
06.01.340	1200 x 500 x 1850	400	3	Rotary bolt for padlock
06.01.341	1200 x 500 x 1850	400	3	Cylinder lock
06.01.430	1190 x 500 x 1850	300	4	Rotary bolt for padlock
06.01.431	1190 x 500 x 1850	300	4	Cylinder lock

Wardrobe lockers with base

Cloakroom cabinets

- Long-lasting steel construction, front panels also made of steel
- Optimal ventilation in the cabinet thanks to the ventilation concept
- Doors hinged on the right, on pintles with vertical box reinforcement, ventilation slots and punched label holders
- Door stop damper
- Insertable hat shelf and wardrobe rail made of oval profile with 3 twist-proof sliding hooks for each compartment
- Rotary bolt for padlock as practical basic equipment



Oval special wardrobe rail with twist-proof double sliding hooks. Enormous load capacity and high operating comfort



Rotary bolt



Cylinder lock



Ventilation concept
The air outlet at the back of the cabinet base ensures good ventilation and drying in the compartment. In the case of base-mounted cabinets, ventilation is provided via openings above the recessed base.



06.02.431

Wardrobe lockers with 100 mm base

Item no.	Dimensions in mm (WxDxH)	Compartment width in mm	Compartments	Description
06.02.230	610 x 500 x 1800	300	2	Rotary bolt for padlock
06.02.231	610 x 500 x 1800	300	2	Cylinder lock
06.02.240	810 x 500 x 1800	400	2	Rotary bolt for padlock
06.02.241	810 x 500 x 1800	400	2	Cylinder lock
06.02.330	900 x 500 x 1800	300	3	Rotary bolt for padlock
06.02.331	900 x 500 x 1800	300	3	Cylinder lock
06.02.340	1200 x 500 x 1800	400	3	Rotary bolt for padlock
06.02.341	1200 x 500 x 1800	400	3	Cylinder lock
06.02.430	1190 x 500 x 1800	300	4	Rotary bolt for padlock
06.02.431	1190 x 500 x 1800	300	4	Cylinder lock

Housing

RAL 5012 RAL 7021 RAL 7035

Fronts

RAL 3000 RAL 3003 RAL 5010 RAL 5012 RAL 5021 RAL 6011 RAL 7021 RAL 7035 RDS 0959059

www.bedrunka-hirth.de

+32 (0)9 232 06 78

info@awp.be

Destelbergen



Steel wardrobe lockers

Wardrobe lockers with bench

- Long-lasting steel construction, front panels also made of steel
- Optimal ventilation in the cabinet thanks to the ventilation concept
- Doors hinged on the right, on pintles with vertical reinforcement, ventilation slots and punched label holders
- Door stop damper
- Insertable hat shelf and wardrobe rail made of oval profile with 3 twist-proof sliding hooks for each compartment
- Rotary bolt for padlock as practical basic equipment
- Seat slats made of beech as standard, profile 60 x 30 mm, planed on all sides, rounded top, clear varnished with natural colour differences
- Seat height 420 mm, seat depth 315 mm, Cabinet depth incl. bench 815 mm
- Standard colour of the bench base frame: RAL 7021, Black grey



Oval special wardrobe rail with twist-proof double sliding hooks. Enormous load capacity and high operating comfort



Rotary bolt



Cylinder lock



Ventilation concept

The air outlet at the back of the cabinet base ensures good ventilation and drying in the compartment. In the case of base-mounted cabinets, ventilation is provided via openings above the recessed base.



06.03.330

Wardrobe lockers with attached bench

Item no.	Dimensions in mm (WxDxH)	Compartment width in mm	Compartments	Description
06.03.230	610 x 815 x 2090	300	2	Rotary bolt for padlock
06.03.231	610 x 815 x 2090	300	2	Cylinder lock
06.03.240	810 x 815 x 2090	400	2	Rotary bolt for padlock
06.03.241	810 x 815 x 2090	400	2	Cylinder lock
06.03.330	900 x 815 x 2090	300	3	Rotary bolt for padlock
06.03.331	900 x 815 x 2090	300	3	Cylinder lock
06.03.340	1200 x 815 x 2090	400	3	Rotary bolt for padlock
06.03.341	1200 x 815 x 2090	400	3	Cylinder lock
06.03.430	1190 x 815 x 2090	300	4	Rotary bolt for padlock
06.03.431	1190 x 815 x 2090	300	4	Cylinder lock

Cloakroom cabinets

- Solid, welded sheet steel construction
- Double-decker
- 2 compartments on top of each other, per compartment 1 door, clothes rail and 3 sliding hooks
- Smooth doors with Rotary bolt lock for padlock
- Compartment size (WxDxH) 230/330 x 465 x 786 mm
- The 400 mm compartment width is also suitable for motorcycle helmets.
- Punched perforated venting rosettes



06.05.2230

**Wardrobe locker with 150 mm feet**

Item no.	Dimensions in mm (WxDxH)	Compartment width in mm	Compartments
06.05.2230	610 x 500 x 1850	300	2 x 2
06.05.2240	810 x 500 x 1850	400	2 x 2
06.05.2330	900 x 500 x 1850	300	3 x 2
06.05.2340	1200 x 500 x 1850	400	3 x 2
06.05.2430	1190 x 500 x 1850	300	4 x 2
06.05.2440	1590 x 500 x 1850	400	4 x 2

**Wardrobe locker with 100 mm base**

Item no.	Dimensions in mm (WxDxH)	Compartment width in mm	Compartments
06.05.2231	610 x 500 x 1800	300	2 x 2
06.05.2241	810 x 500 x 1800	400	2 x 2
06.05.2331	900 x 500 x 1800	300	3 x 2
06.05.2341	1200 x 500 x 1800	400	3 x 2
06.05.2431	1190 x 500 x 1800	300	4 x 2
06.05.2441	1590 x 500 x 1800	400	4 x 2

Compartment lockers

- 3 doors on top of each other
- Solid, welded sheet steel construction
- Rebated, smooth doors with internal pintles
- Single-walled
- Cylinder lock with 2 keys each
- Compartment size (WxDxH) 230/330 x 465 x 510 mm
- The 400 mm compartment width is also suitable for motorcycle helmets.



06.05.3231

**Compartment locker with 150 mm feet**

Item no.	Dimensions in mm (WxDxH)	Compartment width in mm	Compartments
06.05.3230	610 x 500 x 1850	300	2 x 3
06.05.3240	810 x 500 x 1850	400	2 x 3
06.05.3330	900 x 500 x 1850	300	3 x 3
06.05.3340	1200 x 500 x 1850	400	3 x 3
06.05.3430	1190 x 500 x 1850	300	4 x 3

**Compartment locker with 100 mm base**

Item no.	Dimensions in mm (WxDxH)	Compartment width in mm	Compartments
06.05.3231	610 x 500 x 1800	300	2 x 3
06.05.3241	810 x 500 x 1800	400	2 x 3
06.05.3331	900 x 500 x 1800	300	3 x 3
06.05.3341	1200 x 500 x 1800	400	3 x 3
06.05.3431	1190 x 500 x 1800	300	4 x 3

Housing

RAL 5012 RAL 7021 RAL 7035

Fronts

RAL 3000 RAL 3003 RAL 5010 RAL 5012 RAL 5021 RAL 6011 RAL 7021 RAL 7035 RDS 0959059

www.bedrunka-hirth.de

Compartment lockers

Compartment lockers

Compartment lockers with 4 doors on top of each other

- Solid, welded sheet steel construction
- Rebated, smooth doors with internal pintles
- Single-walled
- Cylinder lock with 2 keys each
- Compartment size (WxDxH) 230/330 x 465 x 375 mm
- The 400 mm compartment width is also suitable for motorcycle helmets.



06.05.4341



Compartment locker with 150 mm feet

Item no.	Dimensions in mm (WxDxH)	Compartment width in mm	Compartments
06.05.4230	610 x 500 x 1850	300	2 x 4
06.05.4240	810 x 500 x 1850	400	2 x 4
06.05.4330	900 x 500 x 1850	300	3 x 4
06.05.4340	1200 x 500 x 1850	400	3 x 4
06.05.4430	1190 x 500 x 1850	300	4 x 4



Compartment locker with 100 mm base

Item no.	Dimensions in mm (WxDxH)	Compartment width in mm	Compartments
06.05.4231	610 x 500 x 1800	300	2 x 4
06.05.4241	810 x 500 x 1800	400	2 x 4
06.05.4331	900 x 500 x 1800	300	3 x 4
06.05.4341	1200 x 500 x 1800	400	3 x 4
06.05.4431	1190 x 500 x 1800	300	4 x 4

Compartment lockers with 5 doors on top of each other

- Solid, welded sheet steel construction
- Rebated, smooth doors with internal pintles
- Single-walled
- Cylinder lock with 2 keys each
- Compartment size (WxDxH) 230/330 x 465 x 295 mm
- The 400 mm compartment width is also suitable for motorcycle helmets.



06.05.5230



Compartment locker with 150 mm feet

Item no.	Dimensions in mm (WxDxH)	Compartment width in mm	Compartments
06.05.5230	610 x 500 x 1850	300	2 x 5
06.05.5240	810 x 500 x 1850	400	2 x 5
06.05.5330	900 x 500 x 1850	300	3 x 5
06.05.5340	1200 x 500 x 1850	400	3 x 5
06.05.5430	1190 x 500 x 1850	300	4 x 5



Compartment locker with 100 mm base

Item no.	Dimensions in mm (WxDxH)	Compartment width in mm	Compartments
06.05.5231	610 x 500 x 1800	300	2 x 5
06.05.5241	810 x 500 x 1800	400	2 x 5
06.05.5331	900 x 500 x 1800	300	3 x 5
06.05.5341	1200 x 500 x 1800	400	3 x 5
06.05.5431	1190 x 500 x 1800	300	4 x 5

- Long-lasting steel construction with 3, 4 or 5 compartments on top of each other
- Optionally with plastic feet (for improved corrosion protection) or with base
- One cylinder lock with 2 keys per compartment, other types of lock on request
- The shelves of the compartments are generally in the body colour
- Doors with acrylic glass inserts for a perfect overview, acrylic glass 3 mm thick, internally firmly adhered

Clear entrances dimensions per compartment

Compartment width	Dimensions in mm (WxDxH)	Compartments on top of each other
300	230 x 465 x 510	3
300	230 x 465 x 375	4
300	230 x 465 x 295	5
400	330 x 465 x 375	4
400	330 x 465 x 295	5



06.80.333



06.85.534

Compartment locker with 100 mm base

- Compartment width 300 mm

Item no.	Dimensions in mm (WxDxH)	Compartments
06.80.331	320 x 500 x 1800	1 x 3
06.80.332	610 x 500 x 1800	2 x 3
06.80.333	900 x 500 x 1800	3 x 3
06.80.334	1190 x 500 x 1800	4 x 3
06.80.431	320 x 500 x 1800	1 x 4
06.80.432	610 x 500 x 1800	2 x 4
06.80.433	900 x 500 x 1800	3 x 4
06.80.434	1190 x 500 x 1800	4 x 4
06.80.531	320 x 500 x 1800	1 x 5
06.80.532	610 x 500 x 1800	2 x 5
06.80.533	900 x 500 x 1800	3 x 5
06.80.534	1190 x 500 x 1800	4 x 5

- Compartment width 400 mm (also suitable for motorcycle helmets)

Item no.	Dimensions in mm (WxDxH)	Compartments
06.80.341	420 x 500 x 1800	1 x 3
06.80.342	810 x 500 x 1800	2 x 3
06.80.343	1200 x 500 x 1800	3 x 3
06.80.441	420 x 500 x 1800	1 x 4
06.80.442	810 x 500 x 1800	2 x 4
06.80.443	1200 x 500 x 1800	3 x 4
06.80.541	420 x 500 x 1800	1 x 5
06.80.542	810 x 500 x 1800	2 x 5
06.80.543	1200 x 500 x 1800	3 x 5

Compartment locker with 150 mm feet

- Compartment width 300 mm

Item no.	Dimensions in mm (WxDxH)	Compartments
06.85.331	320 x 500 x 1850	1 x 3
06.85.332	610 x 500 x 1850	2 x 3
06.85.333	900 x 500 x 1850	3 x 3
06.85.334	1190 x 500 x 1850	4 x 3
06.85.431	320 x 500 x 1850	1 x 4
06.85.432	610 x 500 x 1850	2 x 4
06.85.433	900 x 500 x 1850	3 x 4
06.85.434	1190 x 500 x 1850	4 x 4
06.85.531	320 x 500 x 1850	1 x 5
06.85.532	610 x 500 x 1850	2 x 5
06.85.533	900 x 500 x 1850	3 x 5
06.85.534	1190 x 500 x 1850	4 x 5

- Compartment width 400 mm (also suitable for motorcycle helmets)

Item no.	Dimensions in mm (WxDxH)	Compartments
06.85.341	420 x 500 x 1850	1 x 3
06.85.342	810 x 500 x 1850	2 x 3
06.85.343	1200 x 500 x 1850	3 x 3
06.85.441	420 x 500 x 1850	1 x 4
06.85.442	810 x 500 x 1850	2 x 4
06.85.443	1200 x 500 x 1850	3 x 4
06.85.541	420 x 500 x 1850	1 x 5
06.85.542	810 x 500 x 1850	2 x 5
06.85.543	1200 x 500 x 1850	3 x 5

Housing

RAL 5012	RAL 7021	RAL 7035
----------	----------	----------

Fronts

RAL 3000	RAL 3003	RAL 5010	RAL 5012	RAL 5021	RAL 6011	RAL 7021	RAL 7035	RDS 0959059
----------	----------	----------	----------	----------	----------	----------	----------	-------------

www.bedrunka-hirth.de

Multi-purpose cabinets

Clothing and wardrobe lockers

Clothing and wardrobe locker

- Left: 4x shelf
- Right: Hat shelf with clothes rail and 3x sliding hook
- Hinged double doors with a common rotary bolt for a padlock
- Shelves not height-adjustable

Cleaning/equipment cabinet

- To the left of the shortened divider: 4x compartment
- Right: Rail with 6x sliding hook
- Hinged double doors with a common rotary bolt for a padlock
- Shelves not height-adjustable



06.04.330



Clothing and wardrobe locker with 150 mm feet

Item no.	Dimensions in mm (WxDxH)	Description
06.04.230	610 x 500 x 1850	Compartment width 300 mm
06.04.240	810 x 500 x 1850	Compartment width 400 mm



06.04.341



Cleaning/equipment cabinet with 150 mm feet

Item no.	Dimensions in mm (WxDxH)	Description
06.04.330	610 x 500 x 1850	Compartment width 300 mm
06.04.340	810 x 500 x 1850	Compartment width 400 mm



Clothing and wardrobe locker with 100 mm base

Item no.	Dimensions in mm (WxDxH)	Description
06.04.231	610 x 500 x 1800	Compartment width 300 mm
06.04.241	810 x 500 x 1800	Compartment width 400 mm



Cleaning/equipment cabinet with 100 mm base

Item no.	Dimensions in mm (WxDxH)	Description
06.04.331	610 x 500 x 1800	Compartment width 300 mm
06.04.341	810 x 500 x 1800	Compartment width 400 mm

Housing

RAL 5012 RAL 7021 RAL 7035

Fronts

RAL 3000 RAL 3003 RAL 5010 RAL 5012 RAL 5021 RAL 6011 RAL 7021 RAL 7035 RDS 0959059

These fire brigade lockers ensure that your personal protective equipment and also private clothing are always well and safely stored and quick drying is guaranteed. Thanks to the combinability of all models, they can be flexibly adapted to your fire station. And also in terms of colour: in addition to the classic fire red, there is a wide range of other colours to choose from.

Contact us!

Product features and accessories thought out down to the last detail, e.g.

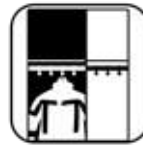

Black-white separation
 Legally compliant
 Black-white separation to avoid carry-over of contamination after use.



Foldable helmet holder
 Helmet holder with effective ventilation function, fits all EU helmet manufacturers and sizes without adjustment, suitable for body sound microphones.



Ventilation / Drying
 Well thought-out ventilation supports the quick drying of the garment.



Other



Terms and conditions

Page 592

Index with product names

Page 594

Index according to item no.

Page 600

GENERAL CONDITIONS OF PAYMENT AND DELIVERY OF BEDRUNKA & HIRTH GMBH BRÄUNLINGEN

1. Scope of validity

1.1 The following terms and conditions are applicable to all our offers, sales, deliveries and services and shall form part of the contract unless a separate contractual agreement is concluded in writing. They shall not apply if our contract partner is a private individual and does not act in a professional or commercial capacity. They shall also apply to all future business relationships, even if they are not expressly agreed as being applicable to future orders.

1.2 We hereby expressly reject any and all deviating or supplemental General Terms and Conditions of the Buyer. These shall also not apply if the Buyer has based his order or other declaration upon them or has rejected the applicability of our General Terms and Conditions.

2. Offers and conclusion of contract

2.1 Our offers are non-binding and may therefore be revoked by us prior to delivery for acceptance by the customer and for 2 working days thereafter, unless they have been described as binding in writing. An effective contract therefore comes into existence only through our order confirmation or the despatch of the goods.

2.2 Dimensions, weights, illustrations, drawings and other documents belonging to our non-binding offers shall remain our property and are indicative only. They shall become a binding part of the contract only with our express written confirmation.

3. Doubtful creditworthiness

3.1 If, after concluding the contract, we become aware of circumstances that cause us to have doubts about the Buyer's ability to pay, we may make further deliveries contingent upon the Buyer making advance payment for the goods. We can require the Buyer to make advance payment within an appropriate period and withdraw from the contract if the advance payment is not paid on time; the Buyer can furnish us with collateral in the form of a bank guarantee instead of the advance payment. If we have already delivered the goods, the purchase price shall immediately become due for payment in full, regardless of any agreed payment deadlines.

3.2 Reasons for doubting the Buyer's ability to pay include the initiation of insolvency proceedings over the Buyer's assets or the failure to make payments to us or third parties on time.

4. Prices

4.1 All prices are net, ex works, without packaging, unless agreed otherwise. The prices applicable on the day of delivery shall always apply. In the case of fixed-price arrangements, we are also entitled to bill proportionately for any increase in the price of materials, salary increases and the like. The prevailing rate of statutory VAT shall be added to all prices.

4.2 Unless agreed otherwise in the offer or order confirmation, packaging shall be charged for separately.

4.3 Shipping / transfer of risk

All risks shall transfer to the Buyer upon handover to the haulier and not later than when the goods leave the factory or warehouse. We are at liberty to choose the shipping method.

4.4 Goods reported as available for despatch on the agreed date must be collected without delay, failing which, we are entitled to store the goods at our own discretion at the Buyer's expense and risk and to charge for them as delivered ex works or ex warehouse. The same shall apply if shipping cannot take place due to traffic stoppages or other circumstances beyond our control.

4.5 Statutory value added tax is not included in our prices and the rate applicable on the billing date shall be indicated separately on the invoice.

4.6 If a delivery within the internal market of the EC was treated as tax-free within the scope of the intra-community supply of goods, even though the prerequisites for this were not met, the delivery shall nevertheless be deemed tax-free if the utilisation of the tax exemption is based on the incorrect information provided by the Buyer and we were unable to identify the incorrect nature of this information, even with the due care of a prudent merchant. In this case, the Buyer shall owe the unpaid tax.

4.7 If more than 4 months pass between the date on which the contract is concluded and the date of delivery, without this being due to a delay in delivery for which Bedrunka+Hirth is responsible, and if our applicable price list has changed during this time, we may demand the list price applicable on the date of delivery instead of the agreed purchase price. We will send the Buyer an appropriately amended order confirmation prior to delivery. In this case, the Buyer may withdraw from its order in respect of the goods for which the price has been increased. The Buyer must declare its intention to withdraw by not later than on the fifth day after receiving the amended order confirmation. This declaration may be sent by fax or email.

5. Delivery time

5.1 All indicated delivery dates are non-binding and are agreed as indicative only, unless we have expressly described them as binding. For non-binding delivery dates, a delivery within 14 days of the indicated delivery date shall in any event still be deemed to be a timely delivery.

5.2 If we are unable to adhere to an expressly agreed deadline or fall behind for other reasons for which we are responsible, the Buyer shall grant us an appropriate grace period. If this grace period expires without success, the Buyer shall be entitled to withdraw from the contract.

5.3 If performance becomes temporarily impossible or considerably more difficult for us, whether in full or in part, due to force majeure or for other extraordinary circumstances beyond our control, the agreed delivery time shall be extended by the duration of the obstacle to performance. The same applies to a deadline for the rendering of service set by the law or by the Buyer, in particular for grace periods set in the event of default.

5.4 Prior to the expiry of the delivery time or the performance deadline extended in accordance with para. 3, the Buyer shall not be entitled to withdraw nor to receive compensation. If the obstacle to performance lasts longer than 3 months, both the Buyer and we shall be entitled to withdraw from the contract if the contract has not yet been executed. If the Buyer is entitled to withdraw from the contract in accordance with the contract or the law (e.g. due to a lack of interest) without setting a grace period, this right shall remain unaffected.

5.5 In the event of a delay in delivery that is not based on intent or gross negligence, claims for compensation of all kinds shall be precluded.

6. Shipping and transport risk

6.1 Delivery shall be ex warehouse, which is also the place of performance for the delivery and any supplementary performance. Upon demand from the customer and at the customer's cost, the goods shall be sent to a different destination (sales shipment). Unless agreed otherwise, we reserve the right to determine the type of shipment (in particular the transport company, dispatch route, pack-aging).

6.2 The risk of accidental destruction and accidental deterioration of the goods shall transfer to the customer upon transfer of the goods at the latest. For mailorder purchases, however, risk of inadvertent destruction and inadvertent deterioration of the goods and the risk of delay shall transfer to the customer upon delivery of the goods to the haulier, freight carrier or other persons or organisations charged with transporting the goods. Insofar as acceptance is agreed, this shall be decisive for the transfer of risk. Moreover, the statutory provisions of the work and services contract law shall apply correspondingly to the agreed acceptance. Transfer or acceptance also applies if the customer is late accepting the goods.

6.3 If the customer is late accepting the goods, if they omit a duty of cooperation or if our delivery is delayed for other reasons attributable to the customer, we reserve the right to demand compensation for resulting damages, including additional costs (e.g. storage costs).

6.4 Unless otherwise expressly agreed in writing, we are authorised to make partial deliveries to a reasonable extent.

6.5 We will charge EUR 7.50 for each notification of delivery requested by the customer that is made by telephone, fax or email

7. Terms of payment

7.1 Our invoices are payable within 10 days from the invoice date with a 2% discount or within 30 days in full.

7.2 The Buyer shall be in default, without any warning by ourselves, if it does not pay the purchase price within 30 days of becoming due and receipt of the invoice or an equivalent demand for payment.

7.3 If the Buyer is late making a payment, all of its payment obligations arising from the business relationship with us shall immediately become due. In this case, we are entitled to demand interest in the legally established amount with effect from the relevant moment. The Vendor reserves the right to provide proof of further damage.

7.4 The Buyer is entitled to set-off, even if complaints or counterclaims are asserted, only if the counterclaims have been legally established, acknowledged by the Vendor or are not in dispute. The Buyer is authorised to exercise its right of retention if its counterclaim is based on the same purchase agreement.

8. Liability

8.1 Information about the properties of goods, as well as references to technical standards in catalogues or other advertising media and our price lists, are for descriptive purposes only and do not form the basis for any guarantee of quality without explicit reference in the order confirmation or in the contract.

8.2 We are not obliged to provide any warranty if the Buyer has not immediately complained about an apparent fault in writing. In the case of hidden faults, which could not be discovered even with careful execution of the obligations of the customer pursuant to Art. 377 German Commercial Code, the complaint shall be raised immediately after the fault has been found. If the product has a fault for which we are responsible and the Buyer complains about it promptly in writing, we will undertake to rectify the fault - to the exclusion of the right of the Buyer to withdraw from the contract or to reduce the purchase price - unless we are entitled to refuse rectification on the basis of a statutory regulation. For each individual fault, the Buyer shall grant us an appropriate period of time in which to effect rectification.

8.3 Rectification can take the form of the elimination of the fault or the delivery of a new product, at the Buyer's option. We are entitled to reject the method of rectification chosen by the Buyer if it is associated with disproportionately high costs. During rectification, a reduction in the purchase price or withdrawal from the contract by the Buyer are precluded. Rectification is deemed to have failed after the second unsuccessful attempt. If rectification has failed or the Vendor has rejected the rectification overall, the Buyer can demand a lowering of the purchase price (reduction) or declare its withdrawal from the contract, at its option.

8.4 The Buyer can only bring claims to compensation under the following conditions because of the fault if the rectification failed or we refused to carry out rectification. The right of the Buyer to bring further claims for compensation under the following conditions remains unaffected.

8.5 In accordance with statutory provisions, we are liable without restriction for intentional or grossly negligent breaches of duty as well as for damage caused by an injury to life, limb or health. Moreover, we shall only be liable if the breached contractual obligation is of material importance for achieving the purpose of the contract and only up to the amount of the typically foreseeable loss.

8.6 The limitation of liability in accordance with para. 5 applies accordingly to other than contractual claims for compensation, in particular claims arising from tortious liability, with the exception of claims in accordance with the German Product Liability Act. It further also applies to the benefit of our executives, employees, workers, representatives and vicarious agents.

8.7 If we have issued a guarantee or quality and/or shelf life in respect of the goods or parts thereof, we shall also be liable within the scope of this guarantee. However, we shall only be liable for damage that is based on the absence of the guaranteed quality or shelf life but does not occur directly on the goods, if the risk of such damage is apparent from the guarantee of quality and shelf life.

8.8 Any further liability is precluded without consideration of the legal nature of the claim brought. Insofar as the Vendor's liability is precluded or limited, this also applies to the personal liability of his executives, employees, workers, representatives and vicarious agents.

8.9 All claims for defects expire 24 months after the transfer or risk, unless any longer periods are mandatorily prescribed pursuant to Articles 438 I (2), 479 I and 634a I (2) German Federal Civil Code.

9. Retention of title

9.1 We shall retain possession of the goods (goods subject to retention of title) until all payments due under the purchase agreement have been received. The delivered goods shall pass into the possession of the Buyer only when the Buyer has fulfilled all of its liabilities under the business relationship, including subsidiary claims, claims for compensation and redemptions of cheques and bills of exchange. In the case of the cheque/bills of exchange procedure, the retention of title in all of its forms listed here shall expire not with the payment by cheque but only with the redemption of the bill of exchange.

9.2 The Buyer shall notify us in writing without delay of all third-party interventions, in particular of enforcement measures and other impairments of its property. The Buyer shall make good all damage and costs we incur, which arise through a breach of this obligation and through necessary measures to protect against third-party interventions.

9.3 If the Buyer does not comply with its obligation to make payment, despite our reminder, we can, without prior notice, demand that the Buyer release the goods that are still in its possession and subject to the retention of title. The Buyer shall bear the transport costs associated with this. The attachment of the matter subject to the retention of title by us always includes a withdrawal from the contract. We are entitled to dispose of the goods subject to the retention of title following their retention. The proceeds of disposal shall be offset against our outstanding claims.

10. Place of fulfilment

The place of fulfilment for payments is Bräunlingen, for our deliveries of goods the place of shipping.

11. Data processing

The Buyer agrees that we may process the data about the Buyer received in connection with the business relationship in accordance with the Federal Data Protection Act for the fulfilment of our business purposes, in particular to store them or transmit them to a credit reference agency, where this is done within the scope of the identified purpose of the contract or required for the preservation of our legitimate interests, and there is no reason to assume that the legitimate interests of the Buyer outweigh the preclusion of the processing of these data, in particular their transmission.

12. Severability clause

Amendments or additions to the contract or these General Terms and Conditions must be made in writing in order to obtain effectiveness. Should a provision of these General Conditions of Delivery and Payment be or become ineffective or unenforceable, this shall not affect the effectiveness of the remaining General Conditions of Delivery and Payment.

13. Jurisdiction and applicable law

13.1 The contractual relationship between the Buyer and ourselves is governed exclusively by the law of the Federal Republic of Germany, even if the Buyer has its place of residence or business abroad. Application of the Uniform Law on the International Purchase of Goods and the Uniform Law on the Formation of Contracts for the International Sale of Goods is precluded.

13.2 The Buyer is not authorised to cede claims arising from the purchase agreement without the permission of the Vendor.

13.3 If the Buyer is a merchant legal entity under public law or a special fund under public law, the place of jurisdiction for both parties - including for complaints regarding cheques and bills of exchange - is Donaueschingen, Germany. We are, however, also entitled to sue the Buyer at its general place of jurisdiction.

Other

Index with product names

Product name	Page
4-foot	342-352, 388-393, 441, 443
4-foot- table	342-348
6- corner group workplace	232-233
8- corner group workplace	247-235

A

A-foot	358-377
Accessories	445-451
After sales services	20
Allen key box	107
Anti- fatigue mat	446
Aqurado	106-107
Armrest	454-455
Artwerkstatt	18-19
Assembly	21
Assembly swift	293
Automatisation	12-13
Axle kit	416

B

Basic table	
- 4-foot	344, 390, 408 - 409
- A-foot	360, 362, 364, 366 - 367, 370 - 371, 374, 444
- C-foot	338, 384
Battery charge cabins	548-549
Beech multiplex panel for maxmobile	465, 469
Benches	580
Bit holder	310
Bottle holder	314, 399, 523
Box workbench	182 - 217
Bracket	284
Bracket for MRS	139
Branding	29
Brochure holder	315, 479

C

C-foot	337-341, 383-387, 440, 442
C-foot table	336-341
Cabinet	
- cabinets with glazed doors	547
- environment protection cabinets	543
- fireproof cabinets	543
- heavy- duty cabinets	546
- hinged door cabinets	164-166, 510, 532-537, 542-549
- multifunction cabinets	536-537
- open fronted storage bin cabinets	538-541
- sliding door cabinets	550-551
- T500	44-67
- T736	68-101

Product name	Page
Cable holder	311
Calliper gauge box	107
Can holder	341, 465, 469, 479
Canner holder	413
Cantilever shelving	570 - 573
Carriage	275,349,399
Caster types	458 - 459
Catalogues	15, 17
Centre compartment rail	64, 98
Certificates	7
Chair	453 - 455, 554 - 563
Chip	111, 121
Circuit breaker	283
Clamp fixing	337, 343, 359,
Cloakroom cabinets	581-585, 587 - 589
CNC	
- accessories	152-157
- box workbench	159
- drawer	71, 77, 85, 134-1335, 550
- drawer cabinet	158, 162
- hinged door cabinet	164-166
- inline workbench	158-159
- mobile workbench	163
- modular system	150-151
- roller shutter cabinet	163
- rotarex	168-171
- tall magazine cabinet	163
- transport trolleys	173-175
- trolley	173-175
- workplace	160
- workshop trolley	172
CNC drawer frame	134-135, 155,, 161
CNC rotating frame	169, 171
CNC suspension	139
CNC table mounted frame	154
CNC tool holder carrier	134-135, 156-57, 161
CNC tool holder frame	167
CNC tool holding shelf	175
CNC tool inserts	152-153
Coffee stand	496
Colours	26-27
Combination holder	310
Company	7
Compartment locker	585-587
Compressed air	229, 239, 281, 387
Computer station	497-198
Computer trolley	499-503
Configurator	6
Consulting	20, 22
Consulting	22 - 25
Container carrier	271, 295, 504
Corner cabin	230

Product name	Page
Corner panel	332-333, 354-355
Corner panel support	328
Corner shelving	567
Cover plate	57, 102, 476-478, 480, 484, 516
Crank adjustment	337, 343, 359, 395
Cross- member	328, 411
Cross- member MRS®	139
Cutting stands	418
Cutting tool	108, 470

D

Depositing box	313, 314, 399, 479
Desinfectant	521
Desinfectant dispenser	521
Desk attachment	510
Diagonal cross- brace	125
Display cabinet	535
Divider	65, 99
Divider for perforated shelves	412 - 414
Divider for shelf MRS®	127
Dividing material	
- for maxmobile 1	104-109
- for maxmobile 2	104-109
- for T500 r 12- 16	104-107
- for T500 r 18- 16	54, 64-65, 104-107
- for T500 r 24- 16	55, 64,65, 104-109
- for T500 r 36- 16	63-65, 104-107
- for T736 r 18- 24	75, 98-100, 104-109
- for T736 r 24- 24	83, 98-100, 104-109
- for T736 r 36- 24	91, 98-100, 104-109
- for T736 r 48- 24	97-100, 104-109
Document holder	285, 295, 3733, 398, 464, 469
Document rack	565
- 4-foot	344, 374
- A-foot	361, 363, 374
Drawer	
- CNC drawer	134-135
- for drawer cabinet/workbench/MRS®	47, 53, 59, 63, 71, 77, 85, 93
- for hinged door cabinet	164-166
- for maxmobile	461-469
- for roller shutter cabinet	162-163
Drawer cabinet	
- accessories	104-109
- CNC	158-162
- mobile	474-485
Drill/hex key holder	310, 479

Product name	Page
E	
Earth leakage circuit breaker	283
Earthing box	445
Earthing cable	445
Earthing module	445
Earthing terminal strip	445
Electronic lock	110-113,121
Electrode	437-438
Emergency stop	229, 239, 281
Energy attachment	233, 235
Energy block	228
Energy duct	279-283
Energy duct mounting bracket	281
Environement protection cabinet	543
Environment protection cabinets and fireproof cabinets	545
Equipment rail	271, 275, 329, 349 - 350
Ergonomics	32-33
ESD	
Expander casters	248, 344, 417, 459, 505

F

Film inscription	29
Fire brigade cabinets	589
Fireproof cabinet	543
Fixed caster	458-459
Flex- box	255-257, 523
Floor anchoring	124, 216, 344, 397
Folder holder	287, 315
Foot frame	
- 4-foot	34-35, 343
- A-foot	35, 359
- C-foot	34-35, 337
- I-foot	34, 319
Footrest	328, 364, 523, 561
Footrest	328
Frame attachment	241

G

Grid subdivision	36 - 37, 43, 178 - 179, 358, 460, 474, 482
Group workplace	232 -234
Guide bracket for workline	375
Guide rail for workline	375

Product name	Page
H	
Half shelf	138 - 139
Hanging base cabinets	259-261
Hanging cabinet workergo	352-353
Hanging cabinet workline	365
Hanging cabinet workline	365
Hanging cabinet workraster	329
Hanging drawer	259
Hanging folder frame	532 - 534
Heavy load cabinet	546
Heavy load tables	380-401
Height adjustable heavy load table	393 - 397, 401
Height adjustable workbench	222 - 223
Height adjustment	
- clamp fixing	337, 343, 359
- crank adjustment	337, 343, 359, 395, 406
- electric	337, 343, 359, 362, 383, 389, 395, 406
- grid adjustment	319
- retrofit kit	362
Helm- rail	274
Hex key holder	310, 479
Hinged door	
- for drawer cabinets	66, 101
- for maxmobile	464, 468
- for mobile drawer cabinets	480-481
- for MRS®	141-142
- for mobile workbenches	488-494
- for workbenches	184-212
Hinged door cabinet	164-166, 510, 532-535, 542, 544, 547
Hinged flap	230
Hose holder	313
Hydline	394 - 397
I	
Impact protection	569
Inclined hook	309
Inclined support for bins	287
Individual solutions	22 - 27, 42 - 43
Industry 4.0	Okt 13
Info bag	287
Info board	250
Infopoint	521
Inline workbench	218 - 229
Installation	22-23
Installation contactor	283

Product name	Page
K	
Keyboard pull- out	253, 287, 259, 411
Kubik	518 - 519
Kubik 5s	520,522
L	
L-foot	34, 319
Label pouch	516
Labeling strip	64, 98
Laser cutting	29
Led workplace lamp	296 - 306
Level compensation plate	124
Lift for vice	242 - 245
Lift/lower chassis retrofittable	217
Lighting	296-306
Locking systems	110-113
M	
Machine feet	67,103
Machine holder	309, 485
Magnet	309
Magnet frame	251
Magnet holder	309
Magnetic board	277
Magnifier lamp	306
Manual switch „memory“	341, 348
Market segments	9
Maxirck	518
Maxmobile	460 - 469
Maxmobile - tool sets	470 - 473
MDF tool plates	100
Measuring and test instrument	438
Media stand	496
Mesh- sided trolleys	517
Metal divider	
- metal divider set	51, 57, 63, 75, 83, 91, 97, 131, 133
- single metal divider	64 - 65, 98 - 99
Minirak	518
Mirror	519
Mobile	
- CNC workbench	161
- computer, measuring and testing stations	496 - 503
- drawer cabinet	474 - 485
- other	512 - 513
- workbench	486 - 495
- workergo	528
- workline	529
- workraster	524 - 527
- workshop trolley	481

Product name	Page
Mobile addition	67, 103, 344, 401, 417
Mobile logistic systems	456 - 529
Mobile office	498
Mobile skips	512 - 513
Modular shelving system	114 - 147
Monitor attachment housing	497, 499, 501 - 503
Monitor bracket	277, 285, 308, 373, 411, 415
Mounting beam for packing tables	404, 407
Mounting block	157
Mounting brackets	157, 161
Mouse tray	407, 500 - 501, 503
Multi- board	175, 452, 504 - 505
Multi- purpose shelving	564
Multi- trolley	452
Multifunction cabinet	536 - 537, 588
Mutli- board setup	262 - 295
Mutimedia box	107

N

Non- slip mat	66, 102, 240
---------------	--------------

O

Open fronted storage bin	286, 295, 308,
Open fronted storage bin cabinets	538-541
Open- ended/ring spanners	107
Optimisation of the space within reach	31, 151
Overhead frame	275
Overview of pictograms	30 - 31

P

Packing table	404 - 419
Pallet shelving	569
Pallet truck plinth	67, 103
Partition wall MRS	125
Parts trolleys	442, 452, 504-509
Pc holder	270, 407
Pcon planning program	25
Pencil cup	315
Perforated side wall	253, 465, 469
Perforated wall	138, 277, 307
Perforated wall setup	465, 469
Pincode	112, 120 - 121, 180, 539
Pivot arm	284 - 287, 372 - 373, 398
Pivot frame	288-291
Planning	7, 22 - 25
Plastic worktop	429
Pliers holder	138, 309
Powerline	382 - 393
Printer pull- out	407

Product name	Page
Production	20 - 21
Pull- out shelf	167
Push handle	67, 103
Push- through protection	569

R

Rack divider	519
Rail for open fronted storage bins	464, 523, 537
Range of hooks	309 - 315
Range of products	8
Rear edge profile	427
Rear wall	125
Retailers	7, 22
Rfid	111, 113
Ribbed rubber mat	66, 102
Ring spanner holder	310
Roll- off edge	67, 102, 314, 476-478, 480, 484
Roll- off holder	313, 399, 411, 523
Roller ball table	374
Roller ball table - bridge	328
Roller base	510
Roller conveyor	575 - 577
Roller shutter cabinet	162 - 163, 287
Rotarex®	168 - 171
Rotary plate	241-244, 442
Round holder	138, 309, 485
Runner	274

S

Saw holder	311-312
Scale	419
Screen printing	29
Screwdriver box	107
Screwdriver holder	310
Service	20 - 21
Service hotline	20
Shelf	
- for drawer cabinets	67, 102
- for hinged and sliding door cabinets	167, 532-534, 536,541-542, 550-551
- for mobile workbenches	488, 490-492, 494
- for MRS®	127, 138-139
- for multi- board setup	278, 285, 290
- for packing tables	411, 413
- for parts trolleys	504-505
- for shelving	566
- for wall mounted hanging cabinets	252
- for workbenches	184-212, 215
- for workergo	350
- for workline	371, 373

Product name	Page
Shelf bracket for roller shutter cabinet and CNC- frame	162
Shelf, 3rd level	241, 364
Shelving	564 - 577
Shelving divider	518
Showroom	18-19
Side cover panel	465, 469
Side end wall	125
Side flap	468
Side panel	127
Side table	404, 417
Sieve bottom for mobile skips	513
Sit.stand stools	453
Sliding door cabinet	550-551
Slotted wall	277,286,398
Small parts boxes	
- single small parts boxes	105
- small parts boxes sets	51, 57, 63, 75, 83, 91, 97, 131, 133, 465, 469, 493
Small roller conveyor	331, 374 - 377, 575 - 577
Socket holder	310
Socket key box	107
Socket panel	229, 239, 282, 387, 398
Soft close	72 - 94
Sorting racks	251
Spacer bars	104-105
Spanner holder	310
Spare part	104-105, 110-113
Spiral cable	445
Spiral vending machine	15
Spool holder	310
Spring balancer	274, 399
Spring balancer	274, 399
Stacking containers	248-249
Stacking stool	555
Stain relief	274, 399
Standard colours	27
Standing aid	561-563
Steering castors	458 - 459
Stool	453, 554 - 555
Stopper	329, 375, 572, 573
Storage box	248 - 249
Storage rack	139
Storage shelf	314
Superstructure stand	372, 398
Support column	274, 288
Support column profile	274, 288, 292, 368, 411, 413
Support frame MRS®	124
Support tray	465, 469
Support tray set with cylinder lock für MRS®	129, 136
Swing door	230
Swivel stool	554
Swivelling laptop tray	465, 469

Product name	Page
T	
T500	
- drawer cabinet	42-62
- individual equipment	64-87
- mobile	474-481
T736	
- drawer cabinet	68-98
- individual equipment	98-99
- mobile	482-485, 486-495
Tabel scale	419
Table trolley	514-515
Tablet holder	294
Tabletop for kubik	519
Terms and condition	592
Textured mat	106
Through dividers	104
Toggle switch	239, 281
Tool clamp	138, 311, 458,
Tool holder	311
Tool holder box	311
Transport trolley	172-175
Tray for transport trolleys	516
Trolley	506 - 507
Trough plates	
- single trough plates	104
- trough plates sets	51, 57, 63, 75, 83, 91, 97, 131, 133
TSM®	10-11, 14-15
Tube holder	310 - 311
TÜV	21
Twist drill box	107

U	
Universal accessorires	241, 253
Universal shelf MRS®	127
Universal workplace lamp	305-306
Unwind stand	418

V	
Vertical pull- out	136-137
Vice	242-247

W	
Wall ending	122
Wall- mounte hanging cabinets	252
Wardrobe rail	582-584
Warranty	21, 30
Waste bag holder for perforated wall	313
Waste bin	465, 469

Product name	Page
Wide-span shelving	568
Work assembly frame (WAF)	511
Work chairs	556-560
Work stool	554
Workalu	420-421
Workbench	
- 6- corner/8- coner	232-233
- accessories	236-261
- box workbench	182-217
- CNC	158-159
- inline workbench	218-228
- mobile workbench	486-495
Workbench bracket	307
Workbench covering	67, 103
Workbench top	237, 331-333, 341, 347, 354-355, 385, 391, 422-431, 440-44
Workbench top end profile	427
Workergo	335-355
Workergo ESD	440-443
Workergo mobile	528
Workline	35, 356-377, 577
Workline ESD	444
Workline mobile	529
Workpiece carrier	328
Workpiece carrier rail	375
Workplace	440-444
Workplace 4.0	10-13
Workplace lamp	296-306
Workplace mats	254
Workplace system	316-421
Workraster	316-333, 577
Workraster ESD	443
Workraster mobile	524-527
Workshop trolley	481, 456-510
Worktop	
- beech mutliplex	327, 331, 333, 341, 347, 354, 355, 385, 391, 424-426
- chipboard with melamin resin coating	327, 331, 333, 341, 347, 354, 355, 385, 391, 431
- ESD conductive	327, 331, 333, 354, 355, 431
- MDF	327, 331, 333, 354, 355, 385, 391, 428-430
- plastic	429
- red beech	385, 391, 426
- with steel edge/cover	425-426
Worktop connector	430
Worktop covers	240
Wrist strap	435
Writing table	516

Product name	Page
--------------	------

Other

Index according to item no.

Item no.	Page	Item no.	Page	Item no.	Page
01-00206	162	01.066M80	477	01.130.700E	101
01.032	260	01.067	52	01.130.800E	101
01.033	260,352	01.067M125	477	01.130.900E	101
01.034	260,352	01.067M80	477	01.130.BLFL	101
01.040	46	01.068	52	01.ASF50-M8	67,103
01.040M125	476	01.068.007-1	64	011057364TRA	103
01.040M80	476	01.068.008	67	011307364TRA	103
01.0411	46	01.068.009	67,499,499	014500221	249
01.0412	46	01.068.012	67	014500222	249
01.0413	46	01.068.450E	186,188	014500223	249
01.0414	46	01.068.600E	186,188	014500224	249
01.0415	46	01.068.700E	66	014500225	249
01.044	46	01.068.800E	66	0153504TRA	67
01.045	46	01.068.900E	66	015500221	249
01.046	46	01.068M125	477	015500222	249
01.046.007-1	64	01.068M80	477	015500223	249
01.046.008	67	01.069	52	015500224	249
01.046.009	67,499	01.069M125	477	015500225	249
01.046.012	67	01.069M80	477	015557364TRA	103
01.046M125	476	01.070.007-1	98	016500221	249
01.046M80	476	01.070.009	103	016500222	249
01.047	46	01.070.012	103	016500223	249
01.047M125	476	01.070.013	102	016500224	249
01.047M80	476	01.070.700EL	101	016500225	249
01.048	46	01.070.700ER	101	0168504TRA	67
01.048M125	476	01.070.800EL	101	017057364TRA	103
01.048M80	476	01.070.800ER	101	017500221	249
01.049	46	01.070.900EL	101	017500222	249
01.049M125	476	01.070.900ER	101	017500223	249
01.049M80	476	01.090	58	017500224	249
01.050.001	110,120,121	01.090M125	478	017500225	249
01.050.002	110	01.090M80	478	018500221	249
01.050.003	110	01.0911	58	018500222	249
01.050.005B	110	01.0912	58	018500223	249
01.050.007-1	98	01.0913	58	018500224	249
01.050.009	103	01.0914	58	018500225	249
01.050.012	103	01.0915	58	019500221	249
01.050.013	102,224,226	01.095	58	019500222	249
01.050.550EL	224,226	01.096	58	019500223	249
01.050.550ER	224,226	01.096M125	478	019500224	249
01.050.700EL	101,224,226	01.096M80	478	019500225	249
01.050.700ER	101,224,226	01.097	58	0198504TRA	67
01.050.800EL	101	01.097M125	478	01ESCHLOSSPS	111,121
01.050.800ER	101	01.097M80	478	01ESCHLOSSVVS	111,121
01.050.900EL	101	01.098	58	01PINFL2	112,120,180
01.050.900ER	101	01.098.007-1	64	01PINFLLI	112,120,180
01.052	260	01.098.008	67	01PINFLRE	112,120,180
01.0520	261,352	01.098.009	67,498,499	01PINSLAUF	112,120,180
01.053	260,352	01.098.012	67	01PINSLEIN	112,120,180
01.053.450E	184,188	01.098.700E	66	01PINSLEINV	121
01.053.500E	481,488	01.098.800E	66	01PINSLEINZ	112,120,180
01.053.600E	184,188	01.098.900E	66	01RFIDFL2	113,120,181
01.053.700E	66,480	01.098.BLFL	66	01RFIDFLLI	113,120,181
01.053.800E	66	01.098M125	478	01RFIDFLRE	113,120,181
01.053.900E	66	01.098M80	478	01RFIDSLAUF	113,120,181
01.0530	261,352	01.099	58	01RFIDSLEIN	113,120,181
01.054	260,352	01.099M125	478	01RFIDSLEINV	121
01.0540	261,352	01.099M80	478	01RFIDSLEINZ	113,120,181
01.060	52	01.100.007-1	98	02.092.01	174
01.060M125	477	01.100.009	103	02.092.02	174
01.060M80	477	01.100.012	103	02.095.03 VA	162,163
01.0611	52	01.100.013	102	02.1000.1	169
01.0612	52	01.100.700E	101	02.1000.2	169
01.0613	52	01.100.800E	101	02.1000.3	169
01.0614	52	01.100.900E	101	02.1080.4V	162
01.0615	52	01.100.BLFL	101	02.117.04.01	165
01.065	52	01.130.007-1	98	02.118.05.01	164
01.066	52	01.130.012	103	02.140V	158
01.066M125	477	01.130.013	102	02.33.87.60	134,135,157,161,172

Item no.	Page	Item no.	Page	Item no.	Page
02.560.31	157	02.R570140	171	03.06.3160	247
02.560.41	157	02.R570150	171	03.06.3180	247
02.560.51	157	02.R570163	171	03.06.4100	247
02.580.05V	172	02.R570180	171	03.06.4125	247
02.580V86	159	02.R570405	171	03.06.4140	247
02.705.30	157	03.0.06.05KA	229	03.06.4150	247
02.705.40	157	03.00.32	430	03.06.5100	247
02.705.50	157	03.00.34	216,344,397	03.06.5125	247
02.708.100	157	03.02-00108	216	03.06.5140	247
02.708.32	157	03.02-00109	216	03.06.5150	247
02.708.40	157	03.02-00110	216	03.068.103	220
02.708.50	157	03.02-00113	216	03.068.103-75	220
02.708.63	157	03.02-00212	216	03.068.221	220
02.708.80	157	03.02-00218	216	03.068.221-75	220
02.709.25	157	03.02-00793	216	03.070.400E	494
02.709.30	157	03.050.400EL	490	03.070.450L	192,200,202,210
02.709.40	157	03.050.400ER	490	03.070.450R	192,200,202,210
02.709.50	157	03.050.450L	190,194,196,198,204,206,208,212	03.070.600	192,200,202,210
02.780.04V	172	03.050.450R	190,194,196,198,204,206,208,212	03.075.000	215
02.85.01	173	03.050.600	190,194,196,198,204,206,208,212,491,492	03.075.00-9	215
02.85.06	173			03.075.001	192
02.85.07	173	03.055.000	215	03.075.001-9	192
02.85.08	173	03.055.00-9	215	03.075.01V	192
02.86.01	173	03.055.001	190	03.075.01V9	192
02.86.07	173	03.055.001-9	190	03.075.03V	192
02.8705.100	156,161,172,174	03.055.01V	190	03.075.03V9	192
02.8705.200	154	03.055.01V9	190	03.075.05V	193
02.8705.400	154,160	03.055.05V	190	03.075.05V9	193
02.8705.500	155,161,172	03.055.05V9	190	03.075.06V	192
02.8707.100	134,156,160,172,173,174	03.055.06V	190	03.075.06V9	192
02.8707.200	154	03.055.06V9	190	03.075.08V	193
02.8707.400	154	03.055.07V	191	03.075.08V9	193
02.8707.500	134,155,160,172	03.055.07V9	191	03.075.09V	193
02.8708.100	156	03.055.08V	191	03.075.09V9	193
02.8710.100	135,156,173	03.055.08V9	191	03.075.10V	193
02.8710.500	135,155	03.055.09V	191	03.075.10V9	193
02.88.00	174	03.055.09V9	191	03.075.11V	193
02.88.01	174	03.055.10V	191	03.075.11V9	193
02.89.01	163	03.055.10V9	191	03.075.12V	193
02.89.WAT.01	157,160,161	03.055.11V	191	03.075.12V9	193
02.89W140	167	03.055.11V9	191	03.098.103	221
02.89WAR900	164,165,167	03.055.12V	191	03.098.103-75	221
02.89WAR9005	167	03.055.12V9	191	03.098.221	221
02.89WARA900	164,165,167	03.06.0100	247	03.098.221-75	221
02.89WARG900	162,163	03.06.0120	247	03.1.06.06SA	229
02.910.01	160,175	03.06.0125	247	03.10.00	215
02.910.02	160,175	03.06.0140	247	03.10.00-9	215
02.95.01	163	03.06.0150	247	03.10.000.6	401
02.95.01.01	163	03.06.0160	247	03.10.001.6	401
02.98.00	162	03.06.0180	247	03.10.001FB	401
02.BELROT	170	03.06.1100	247	03.10.14.01	349
02.R01	169	03.06.1120	247	03.10.25	424
02.R560130	171	03.06.1125	247	03.10.40	215,424
02.R560140	171	03.06.1140	247	03.10.40RB	426
02.R560150	171	03.06.1150	247	03.10.50	424
02.R560225	171	03.06.1160	247	03.10.50RB	426
02.R560230	171	03.06.1180	247	03.1060.25	424
02.R560240	171	03.06.2100	247	03.1060.40	424
02.R560250	171	03.06.2120	247	03.1060.40RB	426
02.R560330	171	03.06.2125	247	03.1060.50	424
02.R560340	171	03.06.2140	247	03.1060.50RB	426
02.R560350	171	03.06.2150	247	03.1090.25	424
02.R570100	171	03.06.2160	247	03.1090.40	424
02.R570103	171	03.06.2180	247	03.1090.40RB	426
02.R570104	171	03.06.3100	247	03.1090.50	424
02.R570106	171	03.06.3120	247	03.1090.50RB	426
02.R570108	171	03.06.3125	247	03.1094.00	192,200,202,210,494
02.R5701100	171	03.06.3140	247	03.1094.01	190,194,196,198,204,206,208,212,490,491,492
02.R570132	171	03.06.3150	247		

Other

Index according to item no.

Item no.	Page	Item no.	Page	Item no.	Page
03.1094.03	210	03.14.22V9	199	03.15.520.2V	223
03.10SLT0.6	400	03.14.23-LV	199	03.15.520HVV	223
03.10SLT1.6	400	03.14.23-LV9	199	03.15.535.2HVV	223
03.12.00	215	03.14.24-LV	199	03.15.535.2V	223
03.12.00-9	215	03.14.24-LV9	199	03.15.54V	201
03.12.001	194	03.14.26-LV	199	03.15.54V9	201
03.12.001-9	194	03.14.26-LV9	199	03.15.580.001	224
03.12.04V	195	03.14.27-LV	199	03.15.580.002	226
03.12.04V9	195	03.14.27-LV9	199	03.15.580.112V	227
03.12.05V	195	03.14.30	214	03.15.580.202V	227
03.12.05V9	195	03.14.30-9	214	03.15.580.212V	227
03.12.06V	195	03.14.30KS	258	03.15.580.222V	227
03.12.06V9	195	03.14.31V	214	03.15.580.232V	227
03.12.07V	195	03.14.31V-9	214	03.15.580.2V	225
03.12.07V9	195	03.14.32V	214	03.15.580.4V	225,267
03.12.08V	195	03.14.32V-9	214	03.15.580.5-1V	225
03.12.08V9	195	03.14.33V	197,266	03.15.580.5V	224
03.12.13V	194	03.14.33V9	197	03.15.580.6-1V	225
03.12.13V9	194	03.14.520V	270	03.15.580.6V	225
03.12.14.01	349	03.15.000.2	222	03.15.580.7-1V	226
03.12.15V	194	03.15.000.3	222	03.15.580.7V	224
03.12.15V9	194	03.15.000.6	401	03.15.580.8V	225
03.12.17V	195	03.15.000.E1	228	03.15.580.9E	228
03.12.17V9	195	03.15.001	200	03.15.580.9V	226
03.12.25	498	03.15.001-9	200	03.15.66	232
03.12.98	241	03.15.001.6	401	03.15.88	234
03.12/60.25	503	03.15.001FB	401	03.15.95	184,186,188,190,192,194,196, 198,200,202,204,206,208,210,212,216,408
03.125.25	341,424	03.15.002	202	03.15.96	216,408
03.125.40	215,385,424	03.15.002-9	202	03.15.98	241
03.125.40RB	385,426	03.15.022V	202	03.1560.25	220,341,347,424
03.125.50	385,424	03.15.022V9	202	03.1560.40	220,424
03.125.50RB	385,426	03.15.026V	203	03.1560.40RB	426
03.1260.25	341,424	03.15.026V9	203	03.1560.50	424
03.1260.40	424	03.15.027V	203	03.1560.50RB	426
03.1260.40RB	426	03.15.027V9	203	03.1590.25	347,424
03.1260.50	424	03.15.028V	203	03.1590.40	391,424
03.1260.50RB	426	03.15.028V9	203	03.1590.40RB	391,426
03.1290.25	424	03.15.029V	203	03.1590.50	391,424
03.1290.40	424	03.15.029V9	203	03.1590.50RB	391,426
03.1290.40RB	426	03.15.030V	203	03.15SLT0.6	400
03.1290.50	424	03.15.030V9	203	03.15SLT1.6	400
03.1290.50RB	426	03.15.031V	203	03.17.00	215
03.14.00	215	03.15.031V9	203	03.17.00-9	215
03.14.00-9	215	03.15.07V	200	03.1760.25	424
03.14.001	196	03.15.07V9	200	03.1760.40	424
03.14.001-9	196	03.15.14.01	349,350	03.1760.50	424
03.14.002	198	03.15.21V	201	03.1775.25	424
03.14.002-9	198	03.15.21V9	201	03.1775.40	215,424
03.14.002-9GL	198	03.15.23V	201	03.1775.50	424
03.14.002GL	198	03.15.23V9	201	03.1790.25	424
03.14.04V	197	03.15.25	341,347,424	03.1790.40	424
03.14.04V9	197	03.15.31V	201	03.1790.50	424
03.14.05V	197	03.15.31V9	201	03.19.00	215
03.14.05V9	197	03.15.32V	201	03.19.00-9	215
03.14.06V	197	03.15.32V9	201	03.19.001	208
03.14.06V9	197	03.15.37V	266	03.19.001-9	208
03.14.07V	197	03.15.40	158,215,222,285,285,391,424	03.19.002	206
03.14.07V9	197	03.15.40.07	394	03.19.002-9	206
03.14.08V	197	03.15.40HV	396,397	03.19.003	204
03.14.08V9	197	03.15.40HVS	394,396,397	03.19.003-9	204
03.14.11V	198	03.15.40RB	385,391,426	03.19.003-9GR	204
03.14.11V9	198	03.15.41V	201	03.19.003GR	204
03.14.13V	196	03.15.41V9	201	03.19.10V	205
03.14.13V9	196	03.15.50	385,391,424	03.19.10V9	205
03.14.16V	268	03.15.50HV	397	03.19.11V	205
03.14.17V	196	03.15.50HVS	397	03.19.11V9	205
03.14.17V9	196	03.15.50RB	385,391,426	03.19.12V	204
03.14.21V	199	03.15.520.1HVV	223	03.19.12V9	204
03.14.21V9	199	03.15.520.1V	223		
03.14.22V	199				

Item no.	Page	Item no.	Page	Item no.	Page
03.19.13V	205	03.20.34V86	159	03.25.2222V	212
03.19.13V9	205	03.20.34V96	159	03.25.2222V9	212
03.19.17V	205	03.20.40	158,160,215,222,385,391,424	03.25.2342V	213
03.19.17V9	205	03.20.40HV	397	03.25.2342V9	213
03.19.18V	205	03.20.40HVS	397	03.25.25	424
03.19.18V9	205	03.20.40RB	385,391,426	03.25.3131V	213
03.19.19V	205	03.20.50	385,391,424	03.25.3131V9	213
03.19.19V9	205	03.20.50HV	397	03.25.40	215,424
03.19.24V	206	03.20.50HVS	397	03.25.40RB	426
03.19.24V9	206	03.20.50RB	385,391,426	03.25.4433V	213
03.19.25V	207	03.20.520.1HVV	223	03.25.4433V9	213
03.19.25V9	207	03.20.520.1V	223	03.25.50	424
03.19.27V	207	03.20.520.2V	223	03.25.50RB	426
03.19.27V9	207	03.20.520HV	223	03.25.5541V	213
03.19.28V	207	03.20.535.2HVV	223	03.25.5541V9	213
03.19.28V9	207	03.20.535.2V	223	03.25.6432V	213
03.19.29V	207	03.20.580.001	224	03.25.6432V9	213
03.19.29V9	207	03.20.580.002	226	03.25.98	241
03.19.30	214	03.20.580.11V	227	03.2560.25	424
03.19.30-9	214	03.20.580.20V	227	03.2560.40	424
03.19.31V	214	03.20.580.21V	227	03.2560.40RB	426
03.19.31V-9	214	03.20.580.22V	227	03.2560.50	424
03.19.32.1V	214	03.20.580.23V	227	03.2560.50RB	426
03.19.32.1V-9	214	03.20.580.2V	225	03.2590.25	424
03.19.32V	208	03.20.580.3V	271	03.2590.40	424
03.19.32V9	208	03.20.580.4V	225,267	03.2590.40RB	426
03.19.33V	209	03.20.580.5-1V	225	03.2590.50	424
03.19.33V9	209	03.20.580.5V	224	03.2590.50RB	426
03.19.34V	209	03.20.580.6-1V	225	03.30.57.14V	227
03.19.34V9	209	03.20.580.6V	225	03.40.57.14V	227
03.19.35V	209	03.20.580.7-1V	226	03.456300.45	255
03.19.35V9	209	03.20.580.7V	224	03.456300.63	255
03.19.36V	209	03.20.580.8V	225	03.456301.45	255
03.19.36V9	209	03.20.580.9E	228	03.456301.63	255
03.19.37V	269	03.20.580.9V	226	03.456302.45	255
03.19.38V	269	03.20.98	241	03.456302.63	255
03.19.42V	207	03.2014.01-1	349	03.456303.45	255
03.19.42V9	207	03.2018-01	215	03.456303.63	255
03.19.44V	209	03.2018-01D	215	03.456304.45	255
03.19.44V9	209	03.2018-02	215	03.456304.63	255
03.19.45V	207	03.2018-02D	215,412	03.50.01	220,221
03.19.45V9	207	03.2018-05	215	03.50.02	220,221
03.19.46V	209	03.2018-05D	215	03.509204	407
03.19.46V9	209	03.2018-06	215	03.53/50.25	499
03.20.000.2	222	03.2018-06D	215	03.5340.35	416
03.20.000.3	222	03.2018-07	215	03.55498	248,505
03.20.000.6	401	03.2018-07D	215	03.55501	248,505
03.20.000.E1	228	03.2018-08	215	03.55504	248,505
03.20.001	210	03.2018-08D	215	03.58.20	232
03.20.001-9	210	03.2018-09	215	03.58.21	234
03.20.001.6	401	03.2018-09D	215	03.66.05V	232
03.20.001FB	401	03.2018-10	222	03.66.11/450V	232
03.20.03V	210	03.2018-11	222	03.66.2.111V	232
03.20.03V9	210	03.2060.25	221,341,347,424	03.66.73-1	233
03.20.04V	211	03.2060.40	221,424	03.66.73-3	233
03.20.04V9	211	03.2060.40RB	426	03.66.73/BL	233
03.20.11V	211	03.2060.50	424	03.66.73/BL2	233
03.20.11V9	211	03.2060.50RB	426	03.700030	404
03.20.13V	211	03.2090.25	347,424	03.700050	404
03.20.13V9	211	03.2090.40	391,424	03.700080	404
03.20.14.01	349	03.2090.40RB	391,426	03.700120	404
03.20.14V	211	03.2090.50	391,424	03.700140	404
03.20.14V9	211	03.2090.50RB	391,426	03.74.16	283
03.20.15V	211	03.20SLT0.6	400	03.74.17	283
03.20.15V9	211	03.20SLT1.6	400	03.74.18	283
03.20.16V	268	03.25.001	212	03.74.19	283
03.20.18V	211	03.25.001-9	212	03.74.20	283
03.20.18V9	211	03.25.1532V	213	03.74.21	283
03.20.25	341,347,424	03.25.1532V9	213		

Other

Index according to item no.

Item no.	Page	Item no.	Page	Item no.	Page
03.7560.25	424	03.87.359	309,485	03.87WFB	252
03.7560.40	424	03.87.363	311	03.88.07V	234
03.7560.50	424	03.87.368	310	03.88.100	244
03.7575.25	424	03.87.369	314,479	03.88.101	244
03.7575.40	215,424	03.87.370	314	03.88.102	244
03.7575.50	424	03.87.371	310	03.88.103	244
03.7590.25	424	03.87.372	310	03.88.104	244
03.7590.40	424	03.87.374	310	03.88.111	244
03.7590.50	424	03.87.375	310	03.88.120	244
03.785.001-1	110,120	03.87.377	310	03.88.122	244
03.81.25	424	03.87.378	310,479	03.88.140	244
03.81.40	215,424	03.87.379	310,479	03.88.144	244
03.81.40RB	426	03.87.380	310	03.88.160	244
03.81.50	424	03.87.381	311	03.88.166	244
03.81.50RB	426	03.87.383	311	03.88.170	244
03.83.736	253	03.87.384	311	03.88.3/400V	235
03.84.04	245	03.87.391	309	03.88.73-1	235
03.84.07	245	03.87.392	309	03.88.73/BL	235
03.84.100	245	03.87.395-10	312,399,464,479	03.88.73/BLB	235
03.84.120	245	03.87.395-18	312,489,537	03.89.100	243
03.84.140	245	03.87.395-28	312	03.89.101	243
03.84.160	245	03.87.395-40	312	03.89.102	243
03.85.120	245	03.87.398	315,479	03.89.105	243
03.85.140	245	03.87.401	309	03.89.111	243
03.86.100	245	03.87.402	309	03.89.122	243
03.86.120	245	03.87.403	309	03.89.125	243
03.86.121	245	03.87.404	309	03.89.150	243
03.86.140	245	03.87.405	309	03.89.155	243
03.86.141	245	03.87.406	309	03.897052	404
03.86.160	245	03.87.407	309	03.90.01	222
03.861.04	238,281	03.87.408	309	03.90.01HV	222
03.87.043-1	307	03.87.409	138,309	03.90.HVMOB	401
03.87.044-1	307	03.87.410	138,309	03.900.001	277,295,308,464,485,523,537
03.87.101-1	307	03.87.411	138,309	03.900.002	277,295,308,464,485,523,537
03.87.102-1	307	03.87.412	138,309	03.900.003	277,295,308,464,481,485,523,537
03.87.103-1	307	03.87.413	138,309	03.900.004	481,485,537
03.87.104-1	307	03.87.414	310	03.900.005	481,485,537
03.87.19	311	03.87.415	310	03.900.01	275,349,399
03.87.301	309	03.87.416	310	03.900.012	271,295,504
03.87.302	309	03.87.417	310	03.900.013	295,504
03.87.303	309	03.87.418	310	03.900.015	295,504
03.87.304	309	03.87.419	310	03.900.025	315
03.87.305	311	03.87.420	311	03.900.05	277,295,308,464,479,485,537
03.87.306	311	03.87.421	311	03.900.06	277,295,308,464,479,485,523,537
03.87.307	311	03.87.422	311	03.900.07	309
03.87.311	138,309	03.87.423	311	03.900.12.01	489
03.87.312	138,309	03.87.424	311	03.900.12.02	489
03.87.313	138,309	03.87.425	313	03.900.14.16	268
03.87.318	309	03.87.426	313	03.900.15.02-01	266
03.87.322	138,309,399	03.87.427	314	03.900.15.13	366
03.87.323	138,309,399	03.87.428	314	03.900.15.14	270
03.87.324	138,309,399	03.87.429	314	03.900.15.20	272,396
03.87.325	311	03.87.430	314,399	03.900.15.20-1	272
03.87.326	311	03.87.431	314	03.900.15.21	272
03.87.327	314	03.87.432	314	03.900.15.21-1	272
03.87.331	138,311	03.87.433	315	03.900.15.22	272
03.87.332	138,311	03.87.434	315	03.900.15.22-1	272
03.87.333	138,311	03.87.435	315	03.900.15.23	272
03.87.334	138,311	03.87.436	315	03.900.15.23-1	272
03.87.335	138,311	03.87.437	315	03.900.15.24	272
03.87.341	138,311,485	03.87.438	315	03.900.15.24-1	272
03.87.342	138,311,485	03.87.486	313	03.900.15.25	272
03.87.343	138,311,485	03.87.500	313	03.900.15.25-1	272
03.87.344	138,311,485	03.87.501	313	03.900.15.30	495
03.87.345	138,311,485	03.87.WFB1000	252	03.900.15.31	495
03.87.350	313	03.87W1000	252	03.900.15.32	495
03.87.355	138,309,485	03.87W1000S	252	03.900.15.33	266
03.87.357	309,485	03.87W1500	252	03.900.15.580.4	267
03.87.358	309,485	03.87W500	252	03.900.20.16	268

Item no.	Page	Item no.	Page	Item no.	Page
03.900.20.20	273	03.935.155.140	274	03.AQ-0116	106
03.900.20.20-1	273	03.935.155.240	274	03.AQ-0117	106
03.900.20.21	273	03.935.650.125	368	03.AQ-0121	106
03.900.20.21-1	273	03.935.650.140	274,411,413	03.AQ-0122	106
03.900.20.22	273	03.935.650.225	368	03.AQ-1118	107
03.900.20.22-1	273	03.935.650.240	274,411,413	03.AQ-1119	107
03.900.20.23	273	03.935.950.125	368	03.AQ-1122	107
03.900.20.23-1	273	03.935.950.140	274,411,413,414	03.AQ-2110	107
03.900.20.24	273	03.935.950.225	368	03.AQ-2111	107
03.900.20.24-1	273	03.935.950.240	274,411,413,414	03.AQ-2112	107
03.900.20.26	273	03.935.TR10L	410,411	03.AQ-2113	107
03.900.20.26-1	273	03.935TR075	288	03.AQ-2114	107
03.900.20.27	271	03.935TR100	288,411	03.AQ-2115	107
03.900.21	267,367	03.935TR125	288	03.AQ-2116	107
03.900.22	269	03.935TR150	288,411	03.AQ-2117	107
03.900.23	269	03.935TR175	288	03.AQ-2118	107
03.900.38	295	03.935TR200	288	03.AQ-2119	107
03.900.40	287	03.935TR200D	288,411	03.AQ-2120	107
03.900.41	313,399	03.960.20-1	350	03.AQ-2122	107
03.900.42	313,399,523	03.960.46	306	03.AQ-2123	107
03.900.43	314,399,523	03.960.52	306	03.AQ-4103	107
03.900.44	274,399	03.960.54	306	03.AQ-4104	107
03.900.45	274,399	03.960.55	306	03.AQ-4105	107
03.900.46	274,399	03.960.90	306	03.AQ.3907	106
03.900.60	274,399	03.961.265	228	03.AQ.555	106
03.900.61	274,399	03.961.2651	228	03.AQ.705	106
03.900.62	274,399	03.983.07	277	03.BH8719	521
03.900.75.18	366	03.983.07SR	290	03.H8719	521
03.9001520WL	369	03.983.10	271,277	03.H8769	522
03.9001521WL	369	03.983.101	277,414	03.H8780	522
03.9001522WL	369	03.983.101SR	290	03.HELM100	274
03.9001523WL	369	03.983.102	160,271,277,505	03.HELM125	274
03.9001524WL	369	03.983.103	277,414	03.HELM150	274
03.9001525WL	369	03.983.104	277	03.HELM175	274
03.907.220	278	03.983.105	277,414	03.HELM200	274
03.907.220SR	290	03.983.106	277	03.HELMLAUFW	274
03.907.320	278	03.983.111	277	03.HELMSTO	274
03.907.420	278	03.983.112	277	03.HUB08175	217
03.910.03	275,329,349	03.983.113	277	03.HUB081759	217
03.910.220	271,278,410,411,413,505	03.983.114	277	03.HUB12075	217
03.910.320	271,278,410,411,413,505	03.983.115	277	03.HUB120759	217
03.910.420	278,411,413,505	03.983.116	277	03.HUB15075	217
03.910.420G	413	03.983.12	277	03.HUB150759	217
03.910.620G	413	03.983.15	277	03.HUB17575	217
03.912.03	275,349	03.983.17	277	03.HUB175759	217
03.912.220	278	03.983.20	277	03.HUB20075	217
03.912.320	278	03.983.53.1	479,485	03.HUB200759	217
03.912.420	278	03.983.530	479	03.M88.100	242
03.915.03	275,329,349,350	03.983.580	485	03.M88.101	242
03.915.220	278,350,411,413	03.983.581	485	03.M88.102	242
03.915.320	278,350,411,412,413	03.983.680	479	03.M88.121	242
03.915.420	278,411,413	03.983.736.1	479,485	03.M88.122	242
03.915.420G	412,413	03.990.01.14	241,287	03.M88.125	242
03.915.620G	413	03.AQ-0100	106	03.M88.150	242
03.917.03	275,349	03.AQ-0101	106	03.M88.151	242
03.917.220	278	03.AQ-0102	107	03.M88.152	242
03.917.320	278	03.AQ-0103	107	03.M88.171	242
03.917.420	278	03.AQ-0104	106	03.M88.172	242
03.920.03	271,275,349	03.AQ-0105	106	03.M88.175	242
03.920.220	278,411,413	03.AQ-0106	106	03.M89.080	242
03.920.320	278,411,413,414	03.AQ-0107	106	03.M89.081	242
03.920.420	278,411,413	03.AQ-0108	106	03.M89.082	242
03.920.420G	413	03.AQ-0109	106	03.M89.100	242
03.920.620G	413,414	03.AQ-0110	106	03.M89.101	242
03.935.125.125	368	03.AQ-0111	106	03.M89.102	242
03.935.125.140	160,271,274,288,292, 410,411,412,413	03.AQ-0112	106	03.M89.120	242
03.935.125.225	368	03.AQ-0113	107	03.M89.121	242
03.935.125.240	160,271,274,288,292, 410,411,412,413	03.AQ-0114	106	03.M89.122	242
		03.AQ-0115	106		

Other

Index according to item no.

Item no.	Page	Item no.	Page	Item no.	Page
03.M89.150	242	0325754ANT	240	03T5125H6.00	184
03.M89.151	242	0325754TRA	240	03T512H60150	184
03.M89.152	242	0340104ANT	240	03T512H60175	184
03.PT01	404	0340604ANT	240	03T512H60250	185
03.PT02	404	0340604SANT	240	03T512H60275	185
03.PT05	404	0340804ANT	240	03T512H60350	185
03.PT06	404	0340804SANT	240	03T512H60375	185
03.PT08	404	03ADAPAWTSL	216	03T512H60450	185
03.PT12	404	03FBDIM	304	03T512H60475	185
03.PT13	404	03L06M50B	298	03T512H60550	185
03.PT14	404	03L06M50E	299	03T512H60575	185
03.PT160900	406	03L06M50P	299	03T512H60650	185
03.PT163000	406	03L06O350P	298	03T512H60675	185
03.PT163001	405	03L06R50E	300	03T512H60750	185
03.PT163002	405	03L06R50P	300	03T512H60775	185
03.PT163500	406	03L09M27-65D	302	03T515H6.00	186
03.PT163800	406	03L09M2765DT	302	03T515H60150	186
03.PT1653	406	03L09M50B	298	03T515H60175	186
03.PT1653D	406	03L09M50D	299	03T515H60250	187
03.PT166000	406	03L09M50E	299	03T515H60275	187
03.PT17	404	03L09M50P	299	03T515H60350	187
03.PT20	407	03L09M50SEND	301	03T515H60375	187
03.PT200600	407	03L09O350P	298	03T515H60450	187
03.PT200900	406	03L09R27-65D	302	03T515H60475	187
03.PT203000	406	03L09R2765DT	302	03T515H60550	187
03.PT203500	406	03L09R50D	300	03T515H60575	187
03.PT203800	406	03L09R50E	300	03T515H60650	187
03.PT2053	406	03L09R50P	300	03T515H60675	187
03.PT205350	407	03L09R50SEND	301	03T515H60750	187
03.PT2053D	406	03L11M27-65D	302	03T515H60775	187
03.PT206000	406	03L11M2765DT	302	03T520H6.00	188
03.PT2062	407	03L11M50D	299	03T520H60250	189
03.PT2064	407	03L11M50E	299	03T520H60275	189
03.PT2065	407	03L11M50P	299	03T520H60350	189
03.PT2066	407	03L11M50SEND	301	03T520H60375	189
03.PT207001	406	03L11R27-65D	302	03T520H60450	189
03.PT207002	406	03L11R2765DT	302	03T520H60475	189
03.PT207003	406	03L11R50D	300	03T520H60550	189
03.PT207004	406	03L11R50E	300	03T520H60575	189
03.PT2082	407	03L11R50P	300	03T520H60650	189
03.PT228100	407	03L11R50SEND	301	03T520H60675	189
03.PT228101	407	03L12M50B	271,298	03T520H60750	189
03.PT2954	413	03L12O350P	298	03T520H60775	189
03.PT2955	413	03L15M50B	298	04.01.0913	506
03.PT2956	412,413,414	03L15O350P	298	04.01.119	543
03.PT2957	412,413,414	03L287144	306	04.01.2013	506
03.PT509001	407	03L287145	306	04.01.219	543
03.PT509002	407	03L287146	306	04.01.3513	507
03.PT509006	407	03L287147	306	04.013.81	541
03.PT509201	404,407	03L287284	306	04.02.0913	506
03.PT704700	406	03L287285	306	04.02.2013	506
03.PT704740	406	03L43SATML	305	04.02.3513	507
03.PT704750	406	03L43SATMR	305	04.03.0913	506
03.PT704800	406	03L43SATRL	305	04.03.2013	506
03.PTACS15	416	03L43SATRR	305	04.03.3513	507
03.PTACS20	416	03L61490	306	04.04.3513	507
03.PTWAAUSS	414	03LVDA3-0600	303	04.044.81	541
03.PTWAHA	414	03LVDA3-0900	303	04.05.3513	507
03.WA114223	419	03LVDA3-1200	303	04.053.013	67,184,188,480,481,488,532
03.WA200927	419	03MONHAL	277,410,411	04.053.014	532
03.WA833B1	419	03MONTRA070	277	04.053.015	532
0310754ANT	240	03MONTRA100	277	04.06.3513	507
0310754TRA	240	03MONTRA125	277	04.060.013	67,186,188,533
0312754ANT	240	03MONTRA150	277	04.060.014	533
0312754TRA	240	03MONTRA175	277	04.060.015	533
0315754ANT	240	03MONTRA200	277	04.090.013	67,164,165,167,534,536
0315754TRA	240	03PPBM125	304	04.090.014	167,534,536
0320754ANT	240	03PPBM150	304	04.090.015	534
0320754TRA	240	03PPLVDA16	304	04.090.14-75	167

Item no.	Page	Item no.	Page	Item no.	Page
04.10.04V	485	04.12.01	487	04.18-1001	513
04.10.05V	484	04.12.02	487	04.18-1003	513
04.10.05V-1	394	04.12.04V	490	04.18-1005	513
04.10.07V	485	04.12.05V	490	04.18-1007	513
04.105	510	04.12.1207	517	04.18-1009	513
04.105.125	500,501,510	04.12.1208	517	04.18-1011	513
04.105.205	500,503,510	04.12.1211	517	04.18-1013	513
04.105.50	510	04.12.1212	517	04.18-1015	513
04.105.BH	500	04.12.1215	517	04.18-1016	513
04.105.CO1	501	04.12.1216	517	04.18-1017	513
04.105.CO2	501	04.12.19V	491	04.18-1018	513
04.105.CM01	501,502,503	04.12.23V	491	04.18-1019	513
04.105.CM02	501	04.12.26V	161	04.18-89525	513
04.105.MAA	500,501,503	04.12.27V	161	04.18-89540	513
04.105.MC125	500	04.12.28V	492	04.18-89560	513
04.105.MKC125	500	04.12.29V	492	04.180.CO1	502,503
04.105.TAA	501	04.12.859-1M	490	04.180.CO2	503
04.105C	500,501	04.12.859-2M	490	04.180.CO3	502
04.105M125	510	04.12.90	493	04.180.CO4	502
04.105MK125	510	04.12.91	493	04.180.CO5	502
04.106	533	04.12.92	493	04.180.CO6	503
04.106.001	533	04.12.93	493	04.180.CO7	503
04.109	166,534	04.12.935M	491	04.188.002	535
04.109.001	534	04.12.995M	492	04.20.01	487
04.11.01	480	04.122	163	04.20.02	487
04.11.04	480	04.130276.65	540	04.200.140	550
04.11.1054	514	04.130276.66	540	04.200.92V10	550
04.11.1058	515	04.130276.67	540	04.200.92V18	550
04.11.1063	514	04.130276.68	540	04.200.94	550
04.11.1067	515	04.144.20	541	04.250.20	230
04.11.1072	514	04.144.22	541	04.250.30	230
04.11.1076	515	04.144.23	541	04.250.35	230
04.11.1081	514	04.144.24	541	04.254.120	551
04.11.1085	515	04.144.28	541	04.254.120FB	551
04.11.1099	514	04.144.29	541	04.254.12H10	551
04.11.1103	515	04.15.01	487	04.254.12H12	551
04.11.1108	514	04.15.02	487	04.254.160	551
04.11.1112	515	04.15.14V	494	04.254.160FB	551
04.110	510	04.15.22V	495	04.254.16H10	551
04.110.125	502,503,510	04.15.24V	495	04.254.16H12	551
04.110.CM	499,502,503	04.15.33V	495	04.255.120	551
04.1100LG	480	04.15.41V	495	04.255.120FB	551
04.110M125	510	04.15.43V	494	04.255.12H10	551
04.112	533	04.15.859M	494	04.255.12H12	551
04.112.04	543	04.153.001	532	04.255.160	551
04.112.05	543	04.153.10FLS	532	04.255.160FB	551
04.112.06	543	04.153.18FLS	532	04.255.16H10	551
04.113.20	541	04.154.070	542	04.255.16H12	551
04.113.21	541	04.154.070FB	542	04.256.120	551
04.113.22	541	04.154.093	542	04.256.120FB	551
04.113.23	541	04.154.093FB	542	04.256.12H10	551
04.116.09	481	04.154.120	542	04.256.12H12	551
04.116LG	481	04.154.120FB	542	04.256.160	551
04.117	166,535	04.155.050	542	04.256.160FB	551
04.118	166,534	04.155.050FB	542	04.256.16H10	551
04.118.002	497	04.155.070	542	04.256.16H12	551
04.118.003	497	04.155.070FB	542	04.41.1016	509
04.118.023	536	04.155.093	542	04.41.3916	509
04.118.023/1	537	04.155.093FB	542	04.41.4116	509
04.118.024	536	04.155.120	542	04.413.20	541
04.118.024/1	537	04.155.120FB	542	04.413.210	541
04.118.026	537	04.156.093	542	04.413.22	541
04.118.026/1	537	04.156.093FB	542	04.413.23	541
04.118.05	497	04.156.120	542	04.413.24	541
04.118.600	497	04.156.120FB	542	04.413.25	541
04.118.601	497	04.158.093	542	04.413.27	541
04.118.607	497	04.158.093FB	542	04.42.1016	508
04.118.608	497	04.158.120	542	04.43.1016	508
04.118.609	497	04.158.120FB	542	04.43.2216	508
04.119	535				

Other

Index according to item no.

Item no.	Page	Item no.	Page	Item no.	Page
04.46.0813	509	04.W13.14.100	545	04S158093	546
04.47.1016	508	04.W13.15.090	545	04S158120	546
04.47.2216	508	04.W13.15.100	545	04S255120	546
04.48.84	517	04.W13.16.090	545	04S255160	546
04.48.85	517	04.W13.16.100	545	04ST500L80	458
04.48.86	517	04.Z13.13.050	544	04ST500LF80	458
04.48.87	517	04.Z13.13.060	544	04ST736B125	458
04.50.37.2	523	04.Z13.13.070	544	04ST736B80	458
04.50.37LW	523	04.Z13.13.080	544	04ST736L125	458
04.512.01	489	04.Z13.13.090	544	04ST736L80	458
04.512.03	488	04.Z13.13.100	544	04ST736LF125	458
04.512.04	489	04.Z13.13.120	544	04ST736LF80	458
04.512.05	488	04.Z13.13.150	544	04SWEL125	458,459
04.512.20	487	04.Z13.14.050	544	04SWELF125	458,459
04.512.30	487	04.Z13.14.060	544	04WB200	459
04.512M	488	04.Z13.14.070	544	04WL200	459
04.515.20	487	04.Z13.14.080	544	04WLF200	459
04.515.30	487	04.Z13.14.090	544	05.0A31-197	572
04.530.01	499	04.Z13.14.100	544	05.0A31-243	572
04.530.02	499	04.Z13.14.120	544	05.0A32-197	572
04.680.01	499	04.Z13.14.150	544	05.0A32-243	572
04.680.02	499	04.Z13.17.050	544	05.0B31-197	572
04.680.10	499	04.Z13.17.060	544	05.0B31-243	572
04.680.C125	499	04.Z13.17.070	544	05.0B32-197	572
04.680.PA	499,503	04.Z13.17.080	544	05.0B32-243	572
04.900.01	516	04.Z13.17.090	544	05.10.20	511
04.900.02	516	04.Z13.17.100	544	05.10.21	511
04.900.03	516	04.Z13.17.120	544	05.10.30	511
04.900.04	516	04.Z13.17.150	544	05.10.31	511
04.900.10	516	04.Z13.18.050	544	05.10.51	511
04.900.11	516	04.Z13.18.060	544	05.10.52	511
04.900.12	516	04.Z13.18.070	544	05.1000.01	563
04.900.13	516	04.Z13.18.080	544	05.1075.01	563
04.980.01	498	04.Z13.18.090	544	05.1100.01	563
04.980.02	498	04.Z13.18.100	544	05.11134.0-08	562
04.980.03	499	04.Z13.18.120	544	05.11134.0-10	562
04.980.04	499	04.Z13.18.150	544	05.11134.08	562
04.980.30	498	04155093G	547	05.1134.05	562
04.IP001	521	04155093G-1	547	05.1134.07	562
04.K13.14.090	545	04155093G-2	547	05.1175.01	563
04.K13.14.100	545	04155120G	547	05.12096K	569
04.K13.15.090	545	04155120G-1	547	05.12316K	569
04.K13.15.100	545	04155120G-2	547	05.12341E	569
04.K13.16.090	545	04156093G	547	05.13020E	569
04.K13.16.100	545	04156093G-1	547	05.15012K	569
04.KK454120	257	04156093G-2	547	05.18083	564
04.KK454121	257	04156120G	547	05.18084	564
04.KK454122	257	04156120G-1	547	05.18085	564
04.KK454123	257	04156120G-2	547	05.18086	564
04.KK454200	256	04158093G	547	05.18103	564
04.KK454210	256	04158120G	547	05.18104	564
04.KK454220	256	04255120G	547	05.18105	564
04.KK454223	256	04255160G	547	05.18106	564
04.KK454230	256	04256120G	547	05.18123	564
04.KK454240	257	04256160G	547	05.18124	564
04.KK454250	257	04GSSGS-L-GK	110,120	05.18125	564
04.KK454270	256	04GSSGS-R-GK	110,120	05.18126	564
04.KWBM125	216	04GSSVS-L-GK	110,120	05.18163	564
04.KWBM200	216	04GSSVS-R-GK	110,120	05.18164	564
04.MAG100/30	502	04MB100	459	05.18165	564
04.RC.01	496	04ML100	459	05.18166	564
04.RC.02	496	04MLF100	459	05.1A31-197	572
04.V13.14.090	545	04S155093	546	05.1A31-243	572
04.V13.14.100	545	04S155093-1	546	05.1A32-197	572
04.V13.15.090	545	04S155120	546	05.1A32-243	572
04.V13.15.100	545	04S155120-1	546	05.1B31-197	572
04.V13.16.090	545	04S156093	546	05.1B31-243	572
04.V13.16.100	545	04S156093-1	546	05.1B32-197	572
04.W13.14.090	545	04S156120	546	05.1B32-243	572
		04S156120-1	546		

Item no.	Page	Item no.	Page	Item no.	Page
05.20101-50	571	05.733131100	569	05.96.12	554
05.20102-50	571	05.733141100	569	05.96.13	554
05.20121-50	571	05.734131100	569	05.96.17	558
05.20122-50	571	05.734141100	569	05.96.18	558
05.20201-50	571	05.7351241100	569	05.96.19	558
05.20202-50	571	05.735131100	569	05.96.20	558
05.20221-50	571	05.737131100	569	05.96.21	558
05.20222-50	571	05.737141100	569	05.96.22	558
05.3250.01	555	05.7540.01	559	05.96.23	558
05.3250.02	555	05.7540.11	559	05.96.24	558
05.3250.04	555	05.7545.01	559	05.96.25	558
05.3250.22	555	05.90102100	568	05.96.26	558
05.3258.01	555	05.9010260	568	05.96.27	561
05.3258.02	555	05.9010280	568	05.96.28	561
05.3258.04	555	05.90103100	568	05.96.30	561
05.3258.22	555	05.9010360	568	05.96.34	562
05.3571.08	554	05.9010380	568	05.96.35	562
05.3571.18	554	05.90104100	568	05.96.36	554
05.3575.08	554	05.9010460	568	05.96.37	554
05.3576.08	554	05.9010480	568	05.96.38	554
05.402-K	571	05.90105100	568	05.96.39	554
05.4665.01	563	05.9010560	568	05.96.40	554
05.4665.01AL	563	05.9010580	568	05.96.41	554
05.4675.01	563	05.90106100	568	05.96.42	554
05.4675.01AL	563	05.9010660	568	05.96.43	554
05.4765.01	563	05.9010680	568	05.96.44	554
05.4765.01AL	563	05.90107100	568	05.96.45	554
05.4775.01	563	05.9010760	568	05.B4-40102-K	569
05.4775.01AL	563	05.9010780	568	05.BM.101	254
05.50508.30	564	05.90114K	568	05.BM.101-2	254
05.50508.40	564	05.90116K	568	05.BM.102	254
05.50508.50	564	05.90118K	568	05.BM.102-2	254
05.50508.60	564	05.90124K	568	05.BM.103	254
05.50509.30	564	05.90126K	568	05.BM.104	254
05.50509.40	564	05.90128K	568	05.DLR-AFKLV	575,576
05.50509.50	564	05.90134K	568	05.H10.01	521
05.50509.60	564	05.90136K	568	05.HZA17307EX	565
05.50510.30	564	05.90138K	568	05.HZA17310EX	565
05.50510.40	564	05.93.32	560	05.HZA17607DA	565
05.50510.50	564	05.93.35	560	05.HZA17610DA	565
05.50510.60	564	05.94.30	561	05.HZA201213KR	575
05.50511.30	564	05.94.31	560	05.HZA202413KR	575
05.50511.40	564	05.94.33	560	05.HZA20307EX	565
05.50511.50	564	05.94.34	560	05.HZA20310EX	565
05.50511.60	564	05.94.36	556	05.HZA20410XM	566
05.50512.30	564	05.94.37	556	05.HZA20413XM	566
05.50512.40	564	05.94.38	557	05.HZA20510S	574
05.50512.50	564	05.94.39	557	05.HZA20510XM	566
05.50512.60	564	05.94.40	556	05.HZA20513S	574
05.50513.30	564	05.94.41	556	05.HZA20513XM	566
05.50513.40	564	05.94.42	556	05.HZA20607DA	565
05.50513.50	564	05.94.43	557	05.HZA20610DA	565
05.50513.60	564	05.94.44	557	05.HZA20610XM	566
05.50516.30	564	05.95.01	561	05.HZA20613XM	566
05.50516.40	564	05.95.02	561	05.HZA23307EX	565
05.50516.50	564	05.95.03	559	05.HZA23310EX	565
05.50516.60	564	05.95.04	559	05.HZA23607DA	565
05.50517.30	564	05.95.05	559	05.HZA23610DA	565
05.50517.40	564	05.95.06	559	05.HZA25410XM	566
05.50517.50	564	05.96.01	160,558	05.HZA25413XM	566
05.50517.60	564	05.96.02	558	05.HZA25510XM	566
05.60101-50	570	05.96.03	558	05.HZA25513XM	566
05.60102-50	570	05.96.04	558	05.HZA25610XM	566
05.60121-50	570	05.96.05	554	05.HZA25613XM	566
05.60122-50	570	05.96.06	554	05.HZA27307EX	565
05.721131100	569	05.96.07	561	05.HZA27310EX	565
05.721141100	569	05.96.08	561	05.HZA27607DA	565
05.722131100	569	05.96.09	394,562	05.HZA27610DA	565
05.722141100	569	05.96.10	562	05.HZA30410XM	566

Other

Index according to item no.

Item no.	Page	Item no.	Page	Item no.	Page
05.HZA30413XM	566	05.ZW46	566,567	06.05.3230	585
05.HZA30510XM	566	0500	70	06.05.3231	585
05.HZA30513XM	566	0500M125	484	06.05.3240	585
05.HZA30610XM	566	0511	70	06.05.3241	585
05.HZA30613XM	566	0512	70	06.05.3330	585
05.HZE20410AXL	567	0513	70	06.05.3331	585
05.HZE20413AXL	567	0514	70	06.05.3340	585
05.HZE20510AXL	567	0515	70	06.05.3341	585
05.HZE20513AXL	567	0550	70	06.05.3430	585
05.HZE25410AXL	567	0550M125	484	06.05.3431	585
05.HZE25413AXL	567	0560	70	06.05.4230	586
05.HZE25510AXL	567	0560M125	484	06.05.4231	586
05.HZE25513AXL	567	0570	70	06.05.4240	586
05.HZE30410AXL	567	0570M125	484	06.05.4241	586
05.HZE30413AXL	567	0580	70	06.05.4330	586
05.HZE30510AXL	567	0580M125	484	06.05.4331	586
05.HZE30513AXL	567	0590	70	06.05.4340	586
05.HZG171213KR	576	0590M125	484	06.05.4341	586
05.HZG17307EX	565	06.01.230	582	06.05.4430	586
05.HZG17310EX	565	06.01.231	582	06.05.4431	586
05.HZG17607DA	565	06.01.240	582	06.05.5230	586
05.HZG17610DA	565	06.01.241	582	06.05.5231	586
05.HZG201213KR	575	06.01.330	582	06.05.5240	586
05.HZG202413KR	575	06.01.331	582	06.05.5241	586
05.HZG20307EX	565	06.01.340	582	06.05.5330	586
05.HZG20310EX	565	06.01.341	582	06.05.5331	586
05.HZG20410XM	566	06.01.430	582	06.05.5340	586
05.HZG20413XM	566	06.01.431	582	06.05.5341	586
05.HZG20510S	574	06.010.F020	581	06.05.5430	586
05.HZG20510XM	566	06.010.F030	581	06.05.5431	586
05.HZG20513S	574	06.010.F040	581	06.055.F020	581
05.HZG20513XM	566	06.02.230	583	06.055.F030	581
05.HZG20607DA	565	06.02.231	583	06.055.F040	581
05.HZG20610DA	565	06.02.240	583	06.155.055E1	549
05.HZG20610XM	566	06.02.241	583	06.155.055E3	549
05.HZG20613XM	566	06.02.330	583	06.155.05E1	549
05.HZG23307EX	565	06.02.331	583	06.155.05E3	549
05.HZG23310EX	565	06.02.340	583	06.50.000	580
05.HZG23607DA	565	06.02.341	583	06.50.010	580
05.HZG23610DA	565	06.02.430	583	06.51.000	580
05.HZG25410XM	566	06.02.431	583	06.51.010	580
05.HZG25413XM	566	06.03.230	584	06.52.000	580
05.HZG25510XM	566	06.03.231	584	06.52.010	580
05.HZG25513XM	566	06.03.240	584	06.5702	548
05.HZG25610XM	566	06.03.241	584	06.701	548
05.HZG25613XM	566	06.03.330	584	06.703	548
05.HZG27307EX	565	06.03.331	584	06.80.331	587
05.HZG27310EX	565	06.03.340	584	06.80.332	587
05.HZG27607DA	565	06.03.341	584	06.80.333	587
05.HZG27610DA	565	06.03.430	584	06.80.334	587
05.HZG30410XM	566	06.03.431	584	06.80.341	587
05.HZG30413XM	566	06.04.230	588	06.80.342	587
05.HZG30510XM	566	06.04.231	588	06.80.343	587
05.HZG30513XM	566	06.04.240	588	06.80.431	587
05.HZG30610XM	566	06.04.241	588	06.80.432	587
05.HZG30613XM	566	06.04.330	588	06.80.433	587
05.HZGRÜ1240	576	06.04.331	588	06.80.434	587
05.HZGRÜ1410	576	06.04.340	588	06.80.441	587
05.HZGTW1240	576	06.04.341	588	06.80.442	587
05.KR13120GE	575	06.05.2230	585	06.80.443	587
05.KR13240GE	575	06.05.2231	585	06.80.531	587
05.KTEM12-100	572,573	06.05.2240	585	06.80.532	587
05.KTEM12-150	572,573	06.05.2241	585	06.80.533	587
05.L11A030-050	572	06.05.2330	585	06.80.534	587
05.L11A030-070	572	06.05.2331	585	06.80.541	587
05.M11A030-1000	573	06.05.2340	585	06.80.542	587
05.M11A040-080	573	06.05.2341	585	06.80.543	587
05.Z505100	574	06.05.2430	585	06.80E1	548
05.Z505130	574	06.05.2431	585	06.85.331	587
05.ZW45	566,567				

Item no.	Page	Item no.	Page	Item no.	Page
06.85.332	587	07.2036	253,259	07.59.75	529
06.85.333	587	07.23107	418	07.59.95	529
06.85.334	587	07.23110	418	07.60.01	375
06.85.341	587	07.23112	418	07.60.02	375
06.85.342	587	07.24.91	365	07.60.03	375
06.85.343	587	07.25.25	364	07.60.10	375
06.85.431	587	07.25.33	241,364	07.60.10.40	374
06.85.432	587	07.25.35	241,364	07.60.10.50	374
06.85.433	587	07.25.90	365	07.60.10.60	374
06.85.434	587	07.25607	418	07.60.100	374
06.85.441	587	07.25610	418	07.60.11	375
06.85.442	587	07.25612	418	07.60.12	375
06.85.443	587	07.25716	418	07.60.15.40	374
06.85.50	580	07.26.91	365	07.60.15.50	374
06.85.51	580	07.26207N	418	07.60.15.60	374
06.85.52	580	07.26210N	418	07.60.150	374
06.85.531	587	07.26212N	418	07.60.37	241
06.85.532	587	07.26216N	418	07.60.37ESD	241
06.85.533	587	07.26218N	418	07.60.37OA	241
06.85.534	587	07.26407	418	07.60.38	241
06.85.541	587	07.26410	418	07.60.38ESD	241
06.85.542	587	07.26412	418	07.60.38OA	241
06.85.543	587	07.26416	418	07.60.40	375
06.8900.7211	539	07.27.90	365	07.60.42	375
06.8900.740	539	07.28.91	365	07.60.44	375
06.8900.7491	539	07.29.91	365	07.60.46	375
06.8900.7492	539	07.30.15	363	07.60.48	375
06.8900.750	539	07.30.15EHV	363	07.60.70	374
07.00.19	270	07.30.15KHV	363	07.60.71	374
07.00.20	364	07.30.20	371	07.60.90	374
07.00.21	364	07.30.21	371	07.60.91	374
07.00.25	364	07.30.25	371	07.60.92	374
07.00.26	364	07.30.26	371	07.60.93	374
07.00.30	253,394	07.30.90	365	07.60.94	374
07.00.40	362	07.35110	418	07.60.95	374
07.00.41	362	07.35112	418	07.61.100	374
07.00.42	362	07.35116	418	07.61.150	374
07.00.43	362	07.35118	418	07.61.70	374
07.00.45	362	07.35120	418	07.75.10	360
07.10.15	361	07.40.00	372	07.75.10EHV	360
07.10.15.10.96	367	07.40.01	372	07.75.10KHV	360
07.10.15KHV	361	07.40.016	387,394,398	07.75.15	366
07.10.70	362	07.40.02	372	07.75.15	360
07.10.70EHV	362	07.40.03	387,398	07.75.15EHV	360
07.10.70KHV	362	07.40.04	387,398	07.75.15KHV	360
07.10.72	363	07.40.06	372,394,398	07.75.17	366
07.10.72KHV	363	07.40.07	372,394,398	07.75.25EHV	364
07.10.75	362	07.45.21	308,415	07.75.25KHV	364
07.10.75EHV	362	07.45.22	308,415	07.75.35	371
07.10.75KHV	362	07.45.26	286,398	07.75.35KHV	371
07.15.15	361	07.5037	258	07.75.41	364
07.15.15KHV	361	07.51.85	529	07.75.41EHV	364
07.15.72	363	07.51.86	529	07.75.41KHV	364
07.15.72KHV	363	07.51.87	529	07.75.46	371
07.18.00	365	07.55.75	529	07.75.46KHV	371
07.18.01	259,329,365	07.55.95	529	07.75.55	370
07.18.02	365	07.55107	418	07.75.55KHV	370
07.18.03	259,365	07.55110	418	07.75.96	370
07.18.04	259,365	07.55112	418	07.75.96KHV	370
07.20.15/40	367	07.58.10	504	07.81.02	329
07.2016	259	07.58.10-1	175	07.8109.32	331
07.2017	259	07.58.12	505	07.8109.32E	331
07.2018	259	07.58.14	504	07.8109.32H	331
07.2019	259	07.58.16	505	07.8109.32M	331
07.2020	259	07.58.17	504	07.8109.34	331
07.2021	259	07.58.18	505	07.8109.34E	331
07.2022	259	07.58.19	505	07.8109.34H	331
07.2031	259	07.58.20	504	07.8109.34M	331
07.2032	259	07.58.22	175,504	07.8109.62	327

Other

Index according to item no.

Item no.	Page	Item no.	Page	Item no.	Page
07.8109.62E	327	07.8115.34M	331	07.861.01-1	281,350
07.8109.62H	327	07.8115.62	327	07.861.03	281
07.8109.62M	327	07.8115.62E	327	07.861.03-1	281
07.8109.64	327	07.8115.62H	327	07.861.04	229,239,282
07.8109.64E	327	07.8115.62M	327	07.861.05	229,239,282
07.8109.64H	327	07.8115.64	327	07.861.06	229,239,282
07.8109.64M	327	07.8115.64E	327	07.861.07	229,235,239,281
07.8109.72	327	07.8115.64H	327	07.861.08	229,233,235,239,281
07.8109.72E	327	07.8115.64M	327	07.861.09	229,239,281
07.8109.72H	327	07.8115.72	327	07.861.10	239,281
07.8109.72M	327	07.8115.72E	327	07.861.10.09	271
07.8109.74	327	07.8115.72H	327	07.861.10.10	279
07.8109.74E	327	07.8115.72M	327	07.861.10.11	279
07.8109.74H	327	07.8115.74	327	07.861.10.12	279
07.8109.74M	327	07.8115.74E	327	07.861.10.13	279
07.8110.32	331	07.8115.74H	327	07.861.10.14	498
07.8110.32E	331	07.8115.74M	327	07.861.1005	238,280
07.8110.32H	331	07.8130.25	333	07.861.11	229,233,235,239,281
07.8110.32M	331	07.8130.25E	333	07.861.12	229,233,235,239,281
07.8110.34	331	07.8130.25H	333	07.861.1251	238,280
07.8110.34E	331	07.8130.25M	333	07.861.1255	238,280
07.8110.34H	331	07.8130.40	333	07.861.13	283
07.8110.34M	331	07.8130.40E	333	07.861.1301	238,280
07.8110.62	327	07.8130.40H	333	07.861.14	229,233,235,282
07.8110.62E	327	07.8130.40M	333	07.861.15	229,233,235,239,282
07.8110.62H	327	07.8140.25	333	07.861.15.10	279,350
07.8110.62M	327	07.8140.25E	333	07.861.15.11	279
07.8110.64	327	07.8140.25H	333	07.861.15.12	279
07.8110.64E	327	07.8140.25M	333	07.861.15.13	279
07.8110.64H	327	07.8140.40	333	07.861.1505	238,280
07.8110.64M	327	07.8140.40E	333	07.861.16	229,233,235,239,282
07.8110.72	327	07.8140.40H	333	07.861.1751	238,280
07.8110.72E	327	07.8140.40M	333	07.861.1801	238,280
07.8110.72H	327	07.8175.25	333	07.861.19	233,235,239,281
07.8110.72M	327	07.8175.25E	333	07.861.20.10	279
07.8110.74	327	07.8175.25H	333	07.861.20.11	279
07.8110.74E	327	07.8175.25M	333	07.861.20.12	279
07.8110.74H	327	07.8175.40	333	07.861.20.13	279
07.8110.74M	327	07.8175.40E	333	07.861.2005	238,280
07.8114.32	331	07.8175.40H	333	07.861.21	233,239,282
07.8114.32E	331	07.8175.40M	333	07.861.26	239,282
07.8114.32H	331	07.8310.01	526	07.861.27	283
07.8114.32M	331	07.8310.02	526	07.861.28	283
07.8114.34	331	07.8310.03	526	07.861.29	283
07.8114.34E	331	07.8310.04	527	07.861.30	283
07.8114.34H	331	07.8310.05	527	07.861.32	229,281
07.8114.34M	331	07.8310.06	527	07.861.33	239,282
07.8114.62	327	07.8310.07	527	07.861.375.1	271
07.8114.62E	327	07.8310.50	526	07.861.500	238,280
07.8114.62H	327	07.8310.811	525	07.861.501	238,280
07.8114.62M	327	07.8310.821	525	07.861.701	238,280
07.8114.64	327	07.8310.912	525	07.861.801	238,280
07.8114.64E	327	07.8310.922	525	07.8610.300	331
07.8114.64H	327	07.8410.112	326	07.8610.400	331
07.8114.64M	327	07.8410.122	326	07.8614.300	331
07.8114.72	327	07.8410.511	326	07.8614.400	331
07.8114.72E	327	07.8410.521	326	07.8615.300	331
07.8114.72H	327	07.8410.811	326	07.8615.400	331
07.8114.72M	327	07.8410.821	326	07.8650.300	331
07.8114.74	327	07.8410.912	326	07.8650.400	331
07.8114.74E	327	07.8410.922	326	07.8690.300	331
07.8114.74H	327	07.8415.112	326	07.8690.400	331
07.8114.74M	327	07.8415.122	326	07.8710.300	331
07.8115.32	331	07.8415.511	326	07.8710.400	331
07.8115.32E	331	07.8415.521	326	07.8714.300	331
07.8115.32H	331	07.8415.811	326	07.8714.400	331
07.8115.32M	331	07.8415.821	326	07.8715.300	331
07.8115.34	331	07.8415.912	326	07.8715.400	331
07.8115.34E	331	07.8415.922	326	07.8750.300	331
07.8115.34H	331				

Item no.	Page	Item no.	Page	Item no.	Page
07.8750.400	331	07.98.13	284	07.M2575.28	431
07.8790.300	331	07.98.14	286	07.M7560.28	431
07.8790.400	331	07.98.15	285,415	07.M7575.28	431
07.8830.300	328	07.98.20	498	07.M7590.28	431
07.8830.400	328	07.98.7069	290	07.M8175.28	431
07.8840.400	328	07.98.7070	290	0700	76
07.89.06	253,353,371,410	07.98.7071	289	071000201	249
07.89.07	329	07.98.7072	289	071000202	249
07.89.08	329	07.98.7073	289	071000203	249
07.89.09	253	07.98.7074	271,289	071000204	249
07.89.10	328	07.98.7080	292	071000205	249
07.89.15	287	07.98.7080-1	290	0711	76
07.89.16	328	07.98.7081	292	0712	76
07.89.17	328	07.98.7082	292	071210201	249
07.89.19	295	07.98.7083	292	071210202	249
07.89.23	295	07.98.7084	292	071210203	249
07.89.24	295	07.98.7085	292	071210204	249
07.89.37	287	07.98.7090	293	071210205	249
07.89.40	328	07.98.7091	293	0713	76
07.89.41	328	07.98.8010	291	0714	76
07.89.42	328	07.98.8011	291	0715	76
07.89.43	328	07.98.8020	291	072000201	249
07.89.45	328	07.98.8021	291	072000202	249
07.89.53	295	07.98.SA	284	072000203	249
07.89/125.23	295	07.E1060.30	431	072000204	249
07.89/125.24	295	07.E1075.30	431	072000205	249
07.8904.300	329	07.E1090.30	431	072120201	249
07.8904.400	329	07.E12560.30	431	072120202	249
07.8907.350	278	07.E12575.30	431	072120203	249
07.8910.1	275,329,349	07.E12590.30	431	072120204	249
07.8910.2	275,329	07.E1560.30	431	072120205	249
07.8910.350	278	07.E1575.30	431,440,441	072170201	249
07.8912.1	275,349	07.E1590.30	431,441	072170202	249
07.8912.350	278	07.E1760.30	431	072170203	249
07.8915.1	271,275,349,350	07.E1775.30	431	072170204	249
07.8915.2	275,329	07.E1790.30	431	072170205	249
07.8915.350	278	07.E2060.30	431	072750201	249
07.8917.1	275	07.E2075.30	431,440,441	072750202	249
07.8920.1	271,275,349,350	07.E2090.30	431,441	072750203	249
07.8920.1D	275	07.E2575.30	431	072750204	249
07.8920.2D	275	07.E7560.30	431	072750205	249
07.8930	294	07.E7575.30	431	074000201	248
07.8931	294	07.E7590.30	431	074000202	248
07.8933	294	07.E8175.30	431	074000203	248
07.8934LW	287,294,414	07.M1060.28	431	074000204	248
07.8934TR	287,294,414	07.M1075.28	431	074000205	248
07.899.00	324	07.M1090.28	431	074210201	248
07.899.01	324	07.M12560.28	341,431	074210202	248
07.899.02	325	07.M12575.28	341,431	074210203	248
07.899.03	325	07.M12575.40	385	074210204	248
07.899.04	324	07.M12575.50	385	074210205	248
07.899.05	324	07.M12590.28	431	0750	76
07.899.06	325	07.M1560.28	341,347,431	075000201	248
07.899.07	325	07.M1575.28	341,347,431	075000202	248
07.89BTR10-0	295	07.M1575.40	385,391	075000203	248
07.89BTR12-0	295	07.M1575.50	385,391	075000204	248
07.89BTR15-0	295	07.M1590.28	347,431	075000205	248
07.98.01	284	07.M1590.40	391	075120201	248
07.98.02	284,350,415	07.M1590.50	391	075120202	248
07.98.03	285,373	07.M1760.28	431	075120203	248
07.98.04	284,373,398	07.M1775.28	431	075120204	248
07.98.05	285,373,398	07.M1790.28	431	075120205	248
07.98.06	285,373	07.M2060.28	341,347,431	075170201	248
07.98.07	285,373,415	07.M2075.28	341,347,431	075170202	248
07.98.08	285,350,373	07.M2075.40	385,391	075170203	248
07.98.09	286,398	07.M2075.50	385,391	075170204	248
07.98.10	286,394,398	07.M2090.28	347,431	075170205	248
07.98.11	286,350,415	07.M2090.40	391	075750201	248
07.98.12	286,398	07.M2090.50	391	075750202	248

Other

Index according to item no.

Item no.	Page	Item no.	Page	Item no.	Page
075750203	248	08.89.50	465,469	115/0044V10	90
075750204	248	08.89.51	465,469	115/0921V10	90
075750205	248	08.89.59	468	115/2224V10	90
0760	76	08.89.60	468	115/24321V10	90
0770	76	08.89.61	468	115/34231V10	90
077000201	248	08.89.62	468	115/42611V10	90
077000202	248	08.89.63	468	115BLH100	75
077000203	248	08.89.70	469	115BLH150	75
077000204	248	08.89.71	468	115BLH200	75
077000205	248	08.89.72	469	115BLH75	75
0780	76	08.89.74	469	116BLH100	75
078000201	248	08.89.75	469	116BLH150	75
078000202	248	08.89.76	469	116BLH200	75
078000203	248	08.89.79	469	116BLH50	75
078000204	248	08.89.81	469	116BLH75	75
078000205	248	08.89.88	468	117BLH100	75
0790	76	08.89.90-1	461	117BLH150	75
08.88.03	463	08.89.91	467	117BLH200	75
08.88.10	464	08.89.92	467	117BLH50	75
08.88.200	109,471	08.89.92-1	461	117BLH75	75
08.88.203	109,471	08.89.93	467	119BLH100	75
08.88.204	109,471	08.90.01	108,470	119BLH50	75
08.88.205	109,471	08.90.02	108,470	119BLH75	75
08.88.206	109,471	08.90.03	108,470	120	103
08.88.207	109,471	08.90.10	108,470	128-1	493
08.88.30	465	08.90.11	108,470	128-3	493
08.88.34	465	08.90.45.60	108	128-7	493
08.88.35	465	08.90.60.60	108	130	83,131
08.88.36	465	08.90.90.60	108	1300	92
08.88.37	465	100/0213V10	88	1300/0222V18	95
08.88.38	465	100/1231V10	88	1300/0900V18	95
08.88.39	465	100/2141V10	88	1300/1122V18	95
08.88.41	465	100/22510V10	88	1300/2131V18	95
08.88.42	465	100/4221V10	88	1311	92
08.88.43	465	100/4311V10	88	1312	92
08.88.60	464	1000	84	1313	92
08.88.61	464	1011	84	1313/0120V18	96
08.88.62	464	1012	84	1313/0323V18	96
08.88.63	464	1013	84	1313/0640V18	96
08.88.64	464	1014	84	1313/4141V18	96
08.88.70	465	1015	84	1314	92
08.88.72	465	1050	84	1315	92
08.88.73	465,469	1060	84	132BLH100	83,131
08.88.74	465	1070	84	132BLH50	83,131
08.88.75	465	1080	84	132BLH75	83,131
08.88.76	465	1090	84	134BLH100	83,131
08.88.77	465,469	110BLH100	75	134BLH50	83,131
08.88.79	465	110BLH150	75	134BLH75	83,131
08.88.81	465	110BLH50	75	1350	92
08.88.89	465,469	110BLH75	75	135BLH100	83,131
08.88.90-1	461	111	75	135BLH150	83,131
08.88.91	464	112BLH100	75	135BLH200	83,131
08.88.92	463	112BLH50	75	135BLH50	83,131
08.88.93	463	112BLH75	75	135BLH75	83,131
08.88.FLGSE	464,468	113/0323V10	89	1360	92
08.89.03	468	113/2223V10	89	1370	92
08.89.10	468	113/22331V10	89	1380	92
08.89.200	472	113/2423V10	89	1380/0221V18	94
08.89.201	472	113/3331V10	89	1380/0420V18	94
08.89.202	472	113/42511V10	89	1380/0700V18	94
08.89.203	472	113BLH100	75	1380/2211V18	94
08.89.204	472	113BLH150	75	138BLH100	83,131
08.89.205	473	113BLH200	75	138BLH150	83,131
08.89.207	473	113BLH50	75	138BLH200	83,131
08.89.208	473	113BLH75	75	138BLH50	83,131
08.89.209	473	114BLH100	75	138BLH75	83,131
08.89.210	473	114BLH150	75	1390	92
08.89.211	473	114BLH50	75	139BLH100	83,131
08.89.303-2	461	114BLH75	75	139BLH150	83,131

Item no.	Page	Item no.	Page	Item no.	Page
139BLH200	83,131	168-130-075	57	185BLH200	97
139BLH50	83,131	168-132	57,469	185BLH75	97
139BLH75	83,131	168-132-075	57	186	103
140	103	168-136-100	57,469	198-130	63
144BLH100	83,131	168-136-150	57,469	198-130-075	63
144BLH150	83,131	168-136-200	57,469	198-132	63
144BLH200	83,131	168-136-75	57	198-132-075	63
144BLH75	83,131	168-137-100	57	198-136-100	63
146-130	51	168-137-150	57	198-136-150	63
146-130-075	51	168-137-200	57	198-136-200	63
146-132	51,493	168-137-75	57	198-136-75	63
146-132-075	51	168-139-100	57,469	198-139-100	63
146-135-100	51	168-139-150	57,469	198-139-150	63
146-135-150	51	168-139-200	57,469	198-139-200	63
146-135-200	51	168-139-75	57	198-139-75	63
146-135-75	51	168-144-100	57	198-141-100	63
146-137-100	51	168-144-150	57	198-141-150	63
146-137-150	51	168-144-200	57	198-141-200	63
146-137-200	51	168-144-75	57	198-141-75	63
146-137-75	51	168-145-100	57	198-142-100	63
146-139-100	51,493	168-145-150	57	198-142-150	63
146-139-150	51	168-145-200	57	198-142-200	63
146-139-200	51	168-145-75	57	198-142-75	63
146-139-75	51	168-146-100	57	198-144-100	63
146-140-100	51	168-146-150	57	198-144-150	63
146-140-150	51	168-146-200	57	198-144-200	63
146-140-200	51	168-146-75	57	198-144-75	63
146-140-75	51	170/0040V10	86	198-146-100	63
146-141-100	51	170/0320V10	86	198-146-150	63
146-141-150	51	170/0600V10	86	198-146-200	63
146-141-200	51	170/1112V10	86	198-146-75	63
146-141-75	51	170/2220V10	86	20.400.060	64
146-142-100	51,493	170/4210V10	86	20.400.085	64
146-142-150	51	170BLH100	91,133	20.400.135	64
146-142-200	51	170BLH150	91,133	20.400.185	64
146-142-75	51	170BLH200	91,133	20.450.060	64
147BLH100	83,131	170BLH75	91,133	20.450.085	64
147BLH150	83,131	171BLH100	91,133	20.600.030	98
147BLH200	83,131	171BLH150	91,133	20.600.050	98
147BLH75	83,131	171BLH200	91,133	20.600.060	64
149BLH100	83,131	171BLH75	91,133	20.600.075	98
149BLH150	83,131	172BLH100	91,133	20.600.085	64
149BLH200	83,131	172BLH150	91,133	20.600.125	98
149BLH50	83,131	172BLH200	91,133	20.600.175	98
149BLH75	83,131	172BLH50	91,133	20.900.060	64
150	91,133	172BLH75	91,133	20.900.085	64
153BLH100	91,133	1741-07	251	2494	315
153BLH150	91,133	1742-07	251	30.050.050	99
153BLH200	91,133	180/0221V10	87	30.050.075	99
153BLH50	91,133	180/2040V10	87	30.050.125	99
153BLH75	91,133	180/2121V10	87	30.050.30	99
155BLH100	91,133	180/22111V10	87	30.075.050	99
155BLH150	91,133	180/3211V10	87	30.075.075	99
155BLH200	91,133	180/4310V10	87	30.075.125	99
155BLH75	91,133	180BLH75	97	30.075.175	99
159BLH100	91,133	181BLH100	97	30.075.30	99
159BLH50	91,133	181BLH75	97	30.100.050	99
159BLH75	91,133	182BLH100	97	30.100.060	65
160	103	182BLH75	97	30.100.075	99
161BLH100	91,133	183BLH100	97	30.100.085	65
161BLH150	91,133	183BLH150	97	30.100.125	99
161BLH200	91,133	183BLH200	97	30.100.135	65
161BLH50	91,133	183BLH75	97	30.100.175	99
161BLH75	91,133	184BLH100	97	30.100.185	65
166BLH100	91,133	184BLH150	97	30.100.30	99
166BLH150	91,133	184BLH200	97	30.125.175	99
166BLH200	91,133	184BLH75	97	30.150.050	99
166BLH75	91,133	185BLH100	97	30.150.060	65
168-130	57	185BLH150	97	30.150.075	99

Other

Index according to item no.

Item no.	Page	Item no.	Page	Item no.	Page
30.150.085	65	4075KU75G	347	46.220	48
30.150.125	99	4075KU90G	347	46.220-75	48
30.150.135	65	4100E160G	348	46.220BR80	417
30.150.175	99	4100E175G	348	46.220M	476
30.150.185	65	4100E190G	348	46.2210	48
30.150.30	99	4100E260G	348	46.2210-75	48
30.200.050	99	4100E275G	348	46.301	48
30.200.060	65	4100E290G	348	46.301-75	48
30.200.075	99	4100KL60G	346	46.301M	270
30.200.085	65	4100KL75G	346	46.500	48
30.200.125	99	4100KL90G	346	46.500-75	48
30.200.135	65	4100KU60G	347	46.500M	479
30.200.175	99	4100KU75G	347	48.022	49
30.200.185	65	4100KU90G	347	48.022-75	49
30.200.30	99	4125E160G	348	48.140	49
30.225.050	99	4125E175G	348	48.140-75	49
30.225.075	99	4125E190G	348	48.21101	49
30.225.125	99	4125E260G	348	48.21101-75	49
30.225.175	99	4125E275G	348	48.420	49
30.225.30	99	4125E290G	348	48.420-75	49
30.250.125	99	4125KL60G	346	48.501	49
30.250.135	65	4125KL75G	346	48.501-75	49
30.250.175	99	4125KL90G	346	48.700	49
30.250.185	65	4125KU60G	347	48.700-75	49
30.300.050	99	4125KU75G	347	4868-01	251
30.300.060	65	4125KU90G	347	4868-03	251
30.300.075	99	4150E160G	348	4868-07	251
30.300.085	65	4150E175G	348	4868-23	251
30.300.125	99	4150E190G	348	4869-01	251
30.300.135	65	4150E260G	348	4869-03	251
30.300.175	99	4150E275G	348	4869-07	251
30.300.185	65	4150E290G	348	4869-23	251
30.300.30	99	4150KL60G	346	4945-130	251
30.400.175	99	4150KL75G	346	4945-131	251
3360-01	251	4150KL90G	346	4945-132	251
3360-10	251	4150KU60G	347	4C150-1	284,350,415
3361-01	251	4150KU75G	347	4C150-2	351
3361-10	251	4150KU90G	347	4C150-3	351
38.011	260,353,416	4175E160G	348	4C150-4	351
38.020	260,353	4175E175G	348	4C150-5	351
38.150	260,353,416	4175E190G	348	4C150-6	351
38.300	260,353,416	4175E260G	348	4C150-7	528
40.303	50	4175E275G	348	4C200-1	351
40.303-75	50	4175E290G	348	4C200-2	351
40.340	50	4175KL60G	346	4C200-3	351
40.340-75	50	4175KL75G	346	4C200-4	351
40.421	50	4175KL90G	346	4C200-5	351
40.421-75	50	4175KU60G	347	4C200-6	351
40.44010	50	4175KU75G	347	4C200-7	528
40.44010-75	50	4175KU90G	347	4CKAS1-2	338,344
40.620	50	4200E160G	348	4CKAS3-6	338,344
40.620-75	50	4200E175G	348	4CKASVERB	338,344
40.701	50	4200E190G	348	4F.150.75	390
40.701-75	50	4200E260G	348	4F.150.75-1	392
4016137000	305,415	4200E275G	348	4F.150.75-2	392
4016221000	305,415	4200E290G	348	4F.150.75-3	393
4075E160G	348	4200KL60G	346	4F.150.75-4	393
4075E175G	348	4200KL75G	346	4F.150.75BM	390
4075E190G	348	4200KL90G	346	4F.150.90	390
4075E260G	348	4200KU60G	347	4F.150.90-1	392
4075E275G	348	4200KU75G	347	4F.150.90-2	392
4075E290G	348	4200KU90G	347	4F.150.90-3	393
4075KL60G	346	44.001	260,353,416	4F.150.90-4	393
4075KL75G	346	44.011	260,353,416	4F.150.90BM	390
4075KL75GB	417	46.021	48	4F.200.75	390
4075KL75GH	417	46.021-75	48	4F.200.75-1	392
4075KL90G	346	46.021BR80	417	4F.200.75-2	392
4075KL90GB	417	46.102	48	4F.200.75-3	393
4075KL90GH	417	46.102-75	48	4F.200.75-4	393
4075KU60G	347				

Item no.	Page	Item no.	Page	Item no.	Page
4F.200.75BM	390	535/111V	222	8,532	
4F.200.90	390	535/300V	261	60.046.200VA-75	47,184,188,476,480,481,488,532
4F.200.90-1	392	550/0002V10	72	60.046.250VA	47,184,188,476,480,481,488,532
4F.200.90-2	392	550/0201V10	72	60.046.250VA-75	47,184,188,476,480,481,488,532
4F.200.90-3	393	550/0400V10	72	60.046.300VA	47,184,188,476,480,481,488,532
4F.200.90-4	393	550/1210V10	72	60.046.300VA-75	47,184,188,476,480,481,488,532
4F.200.90BM	390	550/12200V10	72	60.050.AZ VA	103
4M150KL75GB	528	550/3110V10	72	60.068.075VA	53,186,188,477,533
4M200KL75GB	528	5507	250	60.068.100VA	53,186,188,477,533
4XXXXX60BL	346	5512	250	60.068.100VA-75	53,186,188,477,533
4XXXXX75BL	346	5551B	250	60.068.150VA	53,186,188,477,533
4XXXXX75TR	352,416	55510	250	60.068.150VA-75	53,186,188,477,533
4XXXXX90BL	346	5551R	250	60.068.200VA	53,186,188,477,533
4XXXXX90TR	352,416	5567	250	60.068.200VA-75	53,186,188,477,533
4XXXXXMB100	459	56.01.30	152	60.068.250VA	53,186,188,477,533
4XXXXXMBL100	344,417	56.01.40	152	60.068.250VA-75	53,186,188,477,533
4XXXXXML100	459	56.01.50	152	60.068.300VA	53,186,188,477,533
4XXXXXMLF100	459	56.02.25	152	60.068.300VA-75	53,186,188,477,533
4XXXXXMLL100	344,417	56.02.30	152	60.070.AZ VA	103
50.002.070	104	56.02.40	152	60.095.100VA	163
50.003.046	104	56.02.50	152	60.098.075VA	59,478,534,536
50.004.034	104	56.02.60	152	60.098.100VA	59,164,167,478,498,534,536
50.100.KTK1	105	56.03.30	152	60.098.100VA-75	59,478,534,536
50.100.KTK2	105	56.03.40	152	60.098.150VA	59,164,167,478,534,536
50.100.MP	104	56.03.50	152	60.098.150VA-75	59,478,534,536
50.500.MP	104	5606	250	60.098.200VA	59,164,167,478,534,536
50.700.KTK1	105	57.01.00	153	60.098.200VA-75	59,478,534,536
50.700.KTK2	105	57.01.03	153	60.098.250VA	59,478,534,536
50.700.MP	104	57.01.04	153	60.098.250VA-75	59,478,534,536
500/0900V10	74	57.01.05	153	60.098.300VA	59,478,534,536
500/1222V10	74	57.01.06	153	60.098.300VA-75	59,478,534,536
500/1223V10	74	57.01.08	153	60.10.050V07	85,132
500/1231V10	74	57.01.100	152	60.10.075V10	85,132
500/3131V10	74	57.01.32	152	60.10.100V10	85,132
500/4302V10	74	57.01.40	152	60.10.100V18	85,132
50002070SE	104	57.01.50	152	60.10.125V10	85,132
50003046SE	104	57.01.63	152	60.10.125V18	85,132
50004034SE	104	57.01.80	152	60.10.150V10	85,132
51.002.070	104	580.0111V86	158,160	60.10.150V18	85,132
51.003.046	104	580/0001FL	231	60.10.175V10	85,132
51.004.034	104	580/0010.550V	231	60.10.175V18	85,132
51002070SE	104	580/0110/450V	231	60.10.200V10	85,132
51003046SE	104	580/0140V	231	60.10.200V18	85,132
51004034SE	104	580/0300.400V	231	60.10.200V30	85
52.075.075	105	580/0501V10	73	60.10.250V10	85,132
52.150.075	105	580/1222V10	73	60.10.250V18	85,132
52.150.150	105	580/2.0002V	231	60.10.250V30	85
520/1V	222	580/2.0040V	231	60.10.300	V10
520/1VA-1	261,353	580/2.0202V	231	60.10.300V10	132
52075075SE	105	580/2.0600V	231	60.10.300V18	85,132
52150075SE	105	580/2.1110V	231	60.10.300V30	85
52150150SE	105	580/22111V10	73	60.10.30V18CNC	85,135
53.020	260,353	580/2600V10	73	60.10.40V18CNC	85,135
53.075.075.30	105	580/32201V10	73	60.100.AZ VA	103
53.075.075.65	105	580/3410V10	73	60.100.SC	72,74,78,80,82,86,88,90,94,96
53.150	260,353,416	5914	250	60.13.075V10	93
53.150.075.30	105	60.038.075VA	260	60.13.100V18	93
53.150.075.65	105	60.038.100VA	260,352	60.13.125V18	93
53.150.150.30	105	60.038.150VA	260,352	60.13.150V18	93
53.150.150.65	105	60.046.075VA	47,184,188,260,352,476,480,481,488,532	60.13.175V18	93
53.300	260,353,416	60.046.100VA	47,184,188,260,352,476,480,481,488,532	60.13.200V18	93
530.111V	261,353	60.046.100VA-75	47,184,188,476,480,481,488,532	60.13.250V18	93
5307507530SE	105	60.046.150VA	47,184,188,260,352,476,480,481,488,532	60.130.AZ VA	103
5307507565SE	105	60.046.150VA-75	47,184,188,476,480,481,488,532	60.303	55
5315007530SE	105	60.046.200VA	47,184,188,260,352,476,480,481,488,532		
5315007565SE	105				
5315015030SE	105				
5315015065SE	105				
535/020V	261,353				

Other

Index according to item no.

Item no.	Page	Item no.	Page	Item no.	Page
60.303-75	55	613.63300	56	713/4403V10	81
60.340	55	613.63300-75	56	715/0100V10	82
60.340-75	55	613.920	56	715/0120V10	82
60.41011	55	613.920-75	56	715/0130V10	82
60.41011-75	55	65.040.530	66,476	715/1333V10	82
60.421	55	65.046.530	51,66	715/1900V10	82
60.421-75	55	65.046.531	66	715/2342V10	82
60.50.050V07	71,190,194,196,198,204,206, 208,212,224,226,261,352,484,490,491,492	65.050.730	102,484	770/0040V10	78
60.50.075V10	71,190,194,196,198,204,206, 208,212,224,226,484,490,491,492	65.051.731	102	770/0121V10	78
60.50.100V10	71,190,194,196,198,204,206, 208,212,224,226,261,352,484,490,491,492	65.060.530	66,477	770/0320V10	78
60.50.100V18	71	65.068.530	57,66	770/0600V10	78
60.50.125V10	71,190,194,196,198,204,206, 208,212,224,226,484,490,491,492	65.068.531	66	770/1112V10	78
60.50.125V18	71	65.070.730	102	770/2220V10	78
60.50.150V10	71,190,194,196,198,204,206, 208,212,224,226,261,352,484,490,491,492	65.071.731	102	780.1111V86	158,160
60.50.150V18	71	65.090.530	66,478	780/0420V10	79
60.50.175V10	71,190,194,196,198,204,206, 208,212,224,226,484,490,491,492	65.098.530	63,66	780/1222V10	79
60.50.175V18	71	65.098.531	66	780/1311V10	79
60.50.200V10	71,190,194,196,198,204,206, 208,212,224,226,261,352,484,490,491,492	65.100.730	102	780/2121V10	79
60.50.200V18	71	65.101.731	102	780/3221V10	79
60.50.200V30	71	65.1060.530	480	780/4220V10	79
60.50.250V10	71,190,194,196,198,204,206, 208,212,224,226,484,490,491,492	65.130.730	102	86.1000	518
60.50.250V18	71	65.131.731	102	86.1000.100	518
60.50.250V30	71	66.046.025	67,476	86.2000	518
60.50.300V10	71,190,194,196,198,204,206, 208,212,224,226,261,352,484,490,491,492	66.050.025	102,484	86.2000.100	518
60.50.300V18	71	66.068.025	67,477	86.3000	518
60.50.300V30	71	66.070.025	102	86.3000.100	518
60.50.250V10	71,190,194,196,198,204,206, 208,212,224,226,484,490,491,492	66.098.025	67,478	86.3100	519
60.50.250V18	71	66.100.025	102	86.3100.100	519
60.50.250V30	71	66.130.025	102	86.4000	519
60.50.300V10	71,190,194,196,198,204,206, 208,212,224,226,484,490,491,492	67.046.016	67,476	86.4000.100	519
60.50.300V18	71	67.046.017	67,476	86.5200	519
60.50.300V30	71	67.050.016	102,484	86.5200.100	519
60.50.30V18CNC	71	67.050.017	102,484	86.6140	519
60.50.40V18CNC	71	67.068.016	67,477	86.7010	518
60.620	55	67.068.017	67,477	86.7020	518
60.620-75	55	67.070.016	102	86.7030	518
60.70.050V07	77,130,192,200,202,210,494,550	67.070.017	102	86.7070	519
60.70.075V10	77,130,192,200,202,210,494,550	67.098.016	67,478	86.7075	518
60.70.100V10	77,130,192,200,202,210,494,550	67.098.017	67,478	86.7100	519
60.70.100V18	77,130,550	67.100.016	102	86.7150	519
60.70.125V10	77,130,192,200,202,210,494,550	67.100.017	102	86.7200	519
60.70.125V18	77,130,550	67.1060.016	480	86.7300	518
60.70.150V10	77,130,192,200,202,210,494,550	67.1060.25	480	86.CLEAN55-1	520
60.70.150V18	77,130,550	67.130.016	102	86.CLEAN55-2	520
60.70.175V10	77,130,192,200,202,210,494,550	67.130.017	102	86.H01KUB5	522
60.70.175V18	77,130,550	68.022	54,220	86.H02KUB5	522
60.70.200V10	77,130,192,200,202,210,494,550	68.022-75	54,220	90.23300	61
60.70.200V18	77,130,550	68.140	54,220	90.23300-75	61
60.70.200V30	77	68.140-75	54,220	90.303	61
60.70.250V10	77,130,192,200,202,210,494,550	68.221M	477,479	90.303-75	61
60.70.250V18	77,130,550	68.24100	54	90.340	61
60.70.250V30	77	68.24100-75	54	90.340-75	61
60.70.300V10	77,130,192,200,202,210,494,550	68.420	54,220	90.421	61
60.70.300V18	77,130,550	68.420-75	54,220	90.421-75	61
60.70.300V30	77	68.501	54	90.620	61
60.70.30V18CNC	77,134,550	68.501-75	54	90.620-75	61
60.70.40V18CNC	77,134,550	68.700	54	90.701	61
60.701	55	68.700-75	54	90.701-75	61
60.701-75	55	700/2223V10	80	913.242	62
613.242	56	700/2321V10	80,108	913.242-75	62
613.242-75	56	700/3411V10	80	913.360	62
613.360	56	700/4112V10	80	913.360-75	62
613.360-75	56	700/4302V10	80	913.404	62
613.404	56	700/4501V10	80	913.404-75	62
613.404-75	56	713/0120V10	81	913.41012	62
613.441	56	713/0270V10	81	913.41012-75	62
613.441-75	56	713/0323V10	81	913.441	62
		713/1332V10	81	913.441-75	62
		713/2422V10	81	913.920	62

Item no.	Page	Item no.	Page	Item no.	Page
913.920-75	62	BE2.6090K25	355	E07.24.02	445
98.140	60,221	BE2.7560K25	355	E07.24.03	445,447
98.140-75	60,221	BE2.7575K25	355	E07.24.04	445
98.221	60	BE2.7590K25	355	E07.24.07	445
98.221-75	60	BE2.9060K25	355	E07.24.08	445,446
98.221M	478	BE2.9075K25	355	E07.24.09	445
98.420	60,221	BE2.9090K25	355	E07.24.21	445
98.420-75	60,221	C075E160G	341	E07.24.22	445
98.44000	60	C075E175G	341	E07.60.31	442
98.44000-75	60	C075E260G	341	E07.60.32	442
98.501	60	C075E275G	341	E07.75.1KHEST	444
98.501-75	60	C075KL60G	340	E07.75.1KLST	444
98.700	60,221	C075KL75G	340	E07.75.1KUST	444
98.700-75	60,221	C075KU60G	340	E07.75.KHEMW	444
A03.10.40	425	C075KU75G	340	E07.75.KLMW	444
A03.10.50	425	C100E160G	341	E07.75.KUMW	444
A03.1090.40	425	C100E175G	341	E07.8310.08K	442
A03.1090.50	425	C100E260G	341	E07.899.01	443
A03.125.40	425	C100E275G	341	E1250.681	446
A03.125.50	425	C100KL60G	340	E1250.7004.L	446
A03.12590.40	425	C100KL75G	340	E1310.PF.701	446
A03.12590.50	425	C100KU60G	340	E1310.PF.ESD	446
A03.15.40	425	C100KU75G	340	E1310PF701R	446
A03.15.50	425	C125E160G	341	E1310PF701RES	446
A03.1590.40	425	C125E175G	341	E1402.662.L	447
A03.1590.50	425	C125E260G	341	E1402.662.R	447
A03.20.40	425	C125E275G	341	E1402.662.S	447
A03.20.50	425	C125KL60G	340	E1402.663.R	447
A03.2090.40	425	C125KL75G	340	E1402.663.S	447
A03.2090.50	425	C125KU60G	340	E1402.665.L	447
A03.25.40	425	C125KU75G	340	E1402.665.R	447
A03.25.50	425	C150E160G	341	E1402.665.S	447
A03.2590.40	425	C150E175G	341	E1452.659.R	447
A03.2590.50	425	C150E260G	341	E1453.7300.R	447
A03.81.40	425	C150E275G	341	E1700.ES.B	454
A03.81.50	425	C150KL60G	340	E1700.ES.D	454
AE031040	425	C150KL75G	340	E1700.ESP.S	455
AE031050	425	C150KU60G	340	E1700.KS.13	453,454,455
AE03109040	425	C150KU75G	340	E1700.PU	453
AE03109050	425	C175E160G	341	E1700.S	453
AE0312540	425	C175E175G	341	E1700.VH	453
AE0312550	425	C175E260G	341	E1700.XS	454,455
AE031259040	425	C175E275G	341	E1700.XS.PU	453
AE031259050	425	C175KL60G	340	E1710.ES.B	454
AE031540	425	C175KL75G	340	E1710.ES.D	454
AE031550	425	C175KU60G	340	E1710.ESP.S	455
AE03159040	425	C175KU75G	340	E1710.PU	453
AE03159050	425	C200E160G	341	E2000.ML	438
AE032040	425	C200E175G	341	E2000.TR50	438
AE032050	425	C200E260G	341	E307.B1.Z	446
AE03209040	425	C200E275G	341	E4150E175-04	443
AE03209050	425	C200KL60G	340	E4150E175G	441
AE032540	425	C200KL75G	340	E4150E190G	441
AE032550	425	C200KU60G	340	E4150E275-04	443
AE03259040	425	C200KU75G	340	E4150E275G	441
AE03259050	425	CF.125.75	384	E4150E290G	441
AE038140	425	CF.125.75-1	386	E4150KL75-04	443
AE038150	425	CF.125.75-2	386	E4150KL75G	441
BE1.6060K25	354	CF.125.75BM	384	E4150KL90G	441
BE1.6075K25	354	CF.150.75	384	E4150KU75-04	443
BE1.6090K25	354	CF.150.75-1	386	E4150KU75G	441
BE1.7560K25	354	CF.150.75-2	386	E4150KU90G	441
BE1.7575K25	354	CF.150.75BM	384	E4200E175G	441
BE1.7590K25	354	CF.200.75	384	E4200E190G	441
BE1.9060K25	354	CF.200.75-1	386	E4200E275G	441
BE1.9075K25	354	CF.200.75-2	386	E4200E290G	441
BE1.9090K25	354	CF.200.75BM	384	E4200KL75G	441
BE2.6060K25	355	E06500910VM	446	E4200KL90G	441
BE2.6075K25	355	E06500940VE	446	E4200KU75G	441

Other

Index according to item no.

Item no.	Page	Item no.	Page	Item no.	Page
E4200KU90G	441	EC150KL75-05	442	H03.1760.30	428
E5310.05	450	EC150KL75G	440	H03.1760.40	428
E5310.10	450	EC150KU75-05	442	H03.1760.50	428
E5310.14	450	EC150KU75G	440	H03.1775.30	428
E5310.15	450	EC200E175G	440	H03.1775.40	428
E5310.20	450	EC200E275G	440	H03.1775.50	428
E5310.24	450	EC200KL75G	440	H03.1790.30	428
E5310.25	450	EC200KU75G	440	H03.1790.40	428
E5310.31	450	EE1.6060K30	354	H03.1790.50	428
E5310.32.S	450	EE1.6075K30	354	H03.20.30	428
E5310.33	450	EE1.6090K30	354	H03.20.40	385,391,428
E5310.34	450	EE1.7560K30	354	H03.20.40HV	397
E5310.42	450	EE1.7575K30	354	H03.20.40HVS	397
E5310.43	450	EE1.7590K30	354	H03.20.50	385,391,428
E5310.43.PU	450	EE1.9060K30	354	H03.20.50HV	397
E5310.43.S	450	EE1.9075K30	354	H03.20.50HVS	397
E5310.50	450	EE1.9090K30	354	H03.2060.30	428
E5310.55	450	EE2.6060K30	355	H03.2060.40	428
E5310.64	450	EE2.6075K30	355	H03.2060.50	428
E5310.64.PU	450	EE2.6090K30	355	H03.2090.30	428
E5310.70	450	EE2.7560K30	355	H03.2090.40	391,428
E5310.80	450	EE2.7575K30	355	H03.2090.50	391,428
E5311.R.10	451	EE2.7590K30	355	H03.25.30	428
E5311.R.14	451	EE2.9060K30	355	H03.25.40	428
E5311.R.20	451	EE2.9075K30	355	H03.25.50	428
E5311.R.24	451	EE2.9090K30	355	H03.2560.30	428
E5311.R.34	451	EPGT120	437	H03.2560.40	428
E5311.R.42	451	EPGT120.12.S	437	H03.2560.50	428
E5311.R.43	451	EPGT120.CU.12	437	H03.2590.30	428
E5311.R.64	451	EPGT120.TEST	437	H03.2590.40	428
E5311.Y.10	451	EPGT120.WK	437	H03.2590.50	428
E5311.Y.14	451	ES530.G	438	H03.7560.30	428
E5311.Y.20	451	ESD07.58.12	452	H03.7560.40	428
E5311.Y.24	451	ESD07.58.14	452	H03.7560.50	428
E5311.Y.34	451	ESD07.58.16	452	H03.7575.30	428
E5311.Y.42	451	ESD07.58.18	452	H03.7575.40	428
E5311.Y.43	451	ESDC150KU75G	442	H03.7575.50	428
E5311.Y.64	451	ESRM200.K	439	H03.7590.30	428
E5320.2	448	H03.1060.30	428	H03.7590.40	428
E5320.2.ET	449	H03.1060.40	428	H03.7590.50	428
E5320.3	448	H03.1060.50	428	H03.81.30	428
E5320.3.ET	449	H03.1075.30	428	H03.81.40	428
E5320.3Z	448	H03.1075.40	428	H03.81.50	428
E5320.3Z.ET	449	H03.1075.50	428	HE1.6060K30	354
E5320.4	448	H03.1090.30	428	HE1.6075K30	354
E5320.4.ET	449	H03.1090.40	428	HE1.6090K30	354
E5320.5	448	H03.1090.50	428	HE1.7560K30	354
E5320.5.ET	449	H03.125.40	385,428	HE1.7575K30	354
E5320.6	448	H03.125.50	385,428	HE1.7590K30	354
E5320.6.ET	449	H03.1260.30	428	HE1.9060K30	354
E5320.6D	448	H03.1260.40	428	HE1.9075K30	354
E5320.FA3Z	448	H03.1260.50	428	HE1.9090K30	354
E5320.FA4	448	H03.1275.30	428	HE2.6060K30	355
E5320.FA4.ET	449	H03.1290.30	428	HE2.6075K30	355
E5320.FA5	448	H03.1290.40	428	HE2.6090K30	355
E5320.FA5.ET	449	H03.1290.50	428	HE2.7560K30	355
E5320FA2.3ET	449	H03.15.30	428	HE2.7575K30	355
E5320FA3Z.ET	449	H03.15.40	385,391,428	HE2.7590K30	355
E5321.R.4	449	H03.15.40HV	397	HE2.9060K30	355
E5321.R.5	449	H03.15.40HVS	397	HE2.9075K30	355
E5321.R.6	449	H03.15.50	385,391,428	HE2.9090K30	355
E5321.Y.4	449	H03.15.50HV	397	K03.10.40	426
E5321.Y.5	449	H03.15.50HVS	397	K03.10.50	426
E5321.Y.6	449	H03.1560.30	428	K03.1060.40	426
E7100.VB2	439	H03.1560.40	428	K03.1060.50	426
EB530.MK	438	H03.1560.50	428	K03.1090.40	426
EC150E175-05	442	H03.1590.30	428	K03.1090.50	426
EC150E175G	440	H03.1590.40	391,428	K03.125.40	426
EC150E275-05	442	H03.1590.50	391,428	K03.125.50	426
EC150E275G	440				

Item no.	Page	Item no.	Page	Item no.	Page
K03.12560.40	426	L03.2090.30	430	PA200	427
K03.12560.50	426	L03.2090.40	391,430	PA250	427
K03.12590.40	426	L03.2090.50	391,430	PA81	427
K03.12590.50	426	L03.25.30	430	PT10ETHAMW	413
K03.15.40	426	L03.25.40	430	PT10ROHAMW	410,411
K03.15.50	426	L03.25.50	430	PT1575BU	408,412
K03.1560.40	426	L03.2560.30	430	PT1575HPL	408
K03.1560.50	426	L03.2560.40	430	PT1590BU	408
K03.1590.40	426	L03.2560.50	430	PT1590HPL	408
K03.1590.50	426	L03.2590.30	430	PT15ETHAMW	412,413
K03.20.40	426	L03.2590.40	430	PT15ROHAMW	411
K03.20.50	426	L03.2590.50	430	PT2075BU	408,410
K03.2060.40	426	L03.81.30	430	PT2075HPL	408
K03.2060.50	426	L03.81.40	430	PT2090BU	408
K03.2090.40	426	L03.81.50	430	PT2090HPL	408
K03.2090.50	426	M05.0A31-243	573	PT4150E175B	409
K03.25.40	426	M05.0A31-296	573	PT4150E175H	409
K03.25.50	426	M05.0A32-243	573	PT4150E190B	409
K03.2560.40	426	M05.0A32-296	573	PT4150E190H	409
K03.2560.50	426	M05.0B31-243	573	PT4150E275B	409
K03.2590.40	426	M05.0B31-296	573	PT4150E275H	409
K03.2590.50	426	M05.0B32-243	573	PT4150E290B	409
K03.81.40	426	M05.0B32-296	573	PT4150E290H	409
K03.81.50	426	M05.1A31-243	573	PT4150KL75B	409
KUS03.15.20	429	M05.1A31-296	573	PT4150KL75H	409
KUS03.15.25	429	M05.1A32-243	573	PT4150KL90B	409
KUS03.15.30	429	M05.1A32-296	573	PT4150KL90H	409
KUS03.20.20	429	M05.1B31-243	573	PT4150KU75B	409
KUS03.20.25	429	M05.1B31-296	573	PT4150KU75H	409
KUS03.20.30	429	M05.1B32-243	573	PT4150KU90B	409
KUW03.15.20	429	M05.1B32-296	573	PT4150KU90H	409
KUW03.15.25	429	ME1.6060K28	354	PT4200E175B	409
KUW03.15.30	429	ME1.6075K28	354	PT4200E175H	409
KUW03.20.20	429	ME1.6090K28	354	PT4200E190B	409
KUW03.20.25	429	ME1.7560K28	354	PT4200E190H	409
KUW03.20.30	429	ME1.7575K28	354	PT4200E275B	409
L03.10.30	430	ME1.7590K28	354	PT4200E275H	409
L03.10.40	430	ME1.9060K28	354	PT4200E290B	409
L03.10.50	430	ME1.9075K28	354	PT4200E290H	409
L03.1060.30	430	ME1.9090K28	354	PT4200KL75B	409
L03.1060.40	430	ME2.6060K28	355	PT4200KL75H	409
L03.1060.50	430	ME2.6075K28	355	PT4200KL90B	409
L03.1090.30	430	ME2.6090K28	355	PT4200KL90H	409
L03.1090.40	430	ME2.7560K28	355	PT4200KU75B	409
L03.1090.50	430	ME2.7575K28	355	PT4200KU75H	409
L03.125.30	430	ME2.7590K28	355	PT4200KU90B	409
L03.125.40	385,430	ME2.9060K28	355	PT4200KU90H	409
L03.125.50	385,430	ME2.9075K28	355	PTEK375	415
L03.1260.30	430	ME2.9090K28	355	PTFBXXXXMML50	410
L03.1260.40	430	ML32CHIP	111,121	PTSCHA100548	413
L03.1260.50	430	ML32RFIDK	111,121	PTTAAUFB320	287,410,411
L03.1290.30	430	PA.1060.12	427	RPA100	427
L03.1290.40	430	PA.1075.12	427	RPA125	427,491,492
L03.1290.50	430	PA.1090.12	427	RPA150	427,494
L03.15.30	430	PA.1260.12	427	RPA175	427
L03.15.40	385,391,430	PA.1275.12	427,491,492	RPA200	427
L03.15.50	385,391,430	PA.1290.12	427	RPA250	427
L03.1560.30	430	PA.1560.12	427	RPA75	427
L03.1560.40	430	PA.1590.12	427	RPA81	427
L03.1560.50	430	PA.1760.12	427	SRAB150	139
L03.1590.30	430	PA.1775.12	427	SRAB200	139
L03.1590.40	391,430	PA.1790.12	427	SRAB250	139
L03.1590.50	391,430	PA.2060.12	427	SRAB300	139
L03.20.30	430	PA.2090.12	427	SRBV	124
L03.20.40	385,391,430	PA.2560.12	427	SRDK	125
L03.20.50	385,391,430	PA.2590.12	427	SRFBGE070	127
L03.2060.30	430	PA.7560.12	427	SRFBGE100	127
L03.2060.40	430	PA.7575.12	427	SRFBGL070	127
L03.2060.50	430	PA.7590.12	427	SRFBGL100	127
		PA150	427,494		

Other

Index according to item no.

Item no.	Page	Item no.	Page	Item no.	Page
SRFBT095	126	SRTR100	124	T03.20.50	385,391,429
SRFBT145	126	SRTR200	124,142,143	T03.2060.30	429
SRFBT195	126	SRTR240	124,142,143	T03.2060.40	429
SRFBVERB	126	SRTR280	124,142,143	T03.2060.50	429
SRFLE070/080	141	SRTRGE	139	T03.2090.30	429
SRFLE070/100	141	SRUNDEGE070	127	T03.2090.40	391,429
SRFLE070/200	141	SRUNDEGE100	127	T03.2090.50	391,429
SRFLE070/240	141	SRUNDEGL070	127	T03.81.30	429
SRFLE070/280	141	SRUNDEGL100	127	T03.81.40	429
SRFLE100/080	141	SRUNFBGE070	127	T03.81.50	429
SRFLE100/100	141	SRUNFBGE100	127		
SRFLE100/200	141	SRUNFBGL070	127		
SRFLE100/240	141	SRUNFBGL100	127		
SRFLE100/280	141	SRVACNWT300	139		
SRFLO070/080	141	SRVAHFBCN250	139		
SRFLO070/100	141	SRVZ150/100	137		
SRFLO100/080	141	SRVZ150/200	137		
SRFLO100/100	141	SRVZ150/240	137		
SRHB025	139	SRVZ150/280	137		
SRHB050	139	SRVZ200/100	137		
SRHB075	139	SRVZ200/200	137		
SRHB100	139	SRVZ200/240	137		
SRHFBVZ150	138	SRVZ200/280	137		
SRHFBVZ200	138	SRVZ250/100	137		
SRHFBVZ250	138	SRVZ250/200	137		
SRHFBVZ300	138	SRVZ250/240	137		
SRHFBVZ350	138	SRVZ250/280	137		
SRK01	144	SRVZ300/100	137		
SRK02	144	SRVZ300/200	137		
SRK03	145	SRVZ300/240	137		
SRK04	145	SRVZ300/280	137		
SRK05	146	SRVZ350/100	137		
SRK06	146	SRVZ350/200	137		
SRK07	147	SRVZ350/240	137		
SRK08	147	SRVZ350/280	137		
SRNAP1	124	SRVZLW416	138		
SRNAP2	124	SRZW100	125		
SRNAP4	124	SRZW200	125		
SRRW070/10	125	SRZW240	125		
SRRW070/20	125	SRZW280	125		
SRRW070/24	125	T03.10.30	429		
SRRW070/28	125	T03.10.40	429		
SRRW100/10	125	T03.10.50	429		
SRRW100/20	125	T03.1060.30	429		
SRRW100/24	125	T03.1060.40	429		
SRRW100/28	125	T03.1060.50	429		
SRS AW100	125	T03.1090.30	429		
SRS AW200	125	T03.1090.40	429		
SRS AW240	125	T03.1090.50	429		
SRS AW280	125	T03.125.30	429		
SRSB095	126	T03.125.40	385,429		
SRSB145	126	T03.125.50	385,429		
SRSB195	126	T03.1260.30	429		
SRSTS070/080	129	T03.1260.40	429		
SRSTS070/100	129	T03.1260.50	429		
SRSTS070/130	129	T03.1290.30	429		
SRSTS070/150	129	T03.1290.40	429		
SRSTS100/080	129	T03.1290.50	429		
SRSTS100/100	129	T03.15.30	429		
SRSTS100/130	129	T03.15.40	385,391,429		
SRSTS100/150	129	T03.15.50	385,391,429		
SRSTV070/100	136	T03.1560.30	429		
SRSTV070/200	136	T03.1560.40	429		
SRSTV070/240	136	T03.1560.50	429		
SRSTV070/280	136	T03.1590.30	429		
SRSTV100/100	136	T03.1590.40	391,429		
SRSTV100/200	136	T03.1590.50	391,429		
SRSTV100/240	136	T03.20.30	429		
SRSTV100/280	136	T03.20.40	385,391,429		

