



# LADEKASTEN

 **Screwdriving technology**

 **Workspace Organisation**

 **Safety & Ergonomics**



Your Assembly Workspace Partner

## Schubladenschränke / Drawer cabinets

Allgemeine Produktmerkmale / General product characteristics	10 - 11
<b>Breite / Width 440 mm x Tiefe / Depth 610 mm (RS 440)</b>	<b>15</b>
Bestellbeispiele / Order examples (4 Höhen / Heights)	16 - 17
Schubladeneinteilungssätze / Drawer partition sets	19
<b>Breite / Width 565 mm x Tiefe / Depth 728 mm (RS 565)</b>	<b>21</b>
Bestellbeispiele / Order examples (4 Höhen / Heights)	22 - 23
Schubladeneinteilungssätze / Drawer partition sets	25 - 27
<b>Breite / Width 576 mm x Tiefe / Depth 610 mm (RS 576)</b>	<b>29</b>
Bestellbeispiele / Order examples (4 Höhen / Heights)	30 - 31
Schubladeneinteilungssätze / Drawer partition sets	33 - 35
<b>Breite / Width 718 mm x Tiefe / Depth 728 mm (RS 717)</b>	<b>37</b>
Bestellbeispiele / Order examples (9 Höhen / Heights)	38 - 40
Schubladeneinteilungssätze / Drawer partition sets	42 - 46
<b>Breite / Width 990 mm x Tiefe / Depth 806 mm (RS 1000)</b>	<b>47</b>
Bestellbeispiele / Order examples (2 Höhen / Heights)	48 - 49
Schubladeneinteilungssätze / Drawer partition sets	50 - 52
<b>Breite / Width 1024 x Tiefe / Depth 728 (RS 1024)</b>	<b>53</b>
Bestellbeispiele / Order examples (4 Höhen / Heights)	54
Schubladeneinteilungssätze / Drawer partition sets	56 - 57
<b>Breite / Width 1196 mm x Tiefe / Depth 728 mm (RS 1196)</b>	<b>59</b>
Bestellbeispiele / Order examples (4 Höhen / Heights)	60
Schubladeneinteilungssätze / Drawer partition sets	62 - 63
<b>Breite / Width 1434 mm x Tiefe / Depth 728 mm (RS 1434)</b>	<b>65</b>
Bestellbeispiele / Order examples (3 Höhen / Heights)	66
Schubladeneinteilungssätze / Drawer partition sets	68 - 69
<b>Eckschrank für Schranktiefe 728 mm</b>	
Corner cabinet for cabinet depth 728 mm	<b>64</b>
Pendeltüre / One wing swing door	64

## Schubladenregale / Shelf unit with drawers

Bestellbeispiele / Order examples	72 - 73
-----------------------------------	---------

## Betriebsmittelausgabe-Automaten

Machines for operating resources

**74 - 81**

# Schubladenschränke | Varianten

## Drawer cabinets | Versions

Breite / Width 440 mm x Tiefe / Depth 610 mm (RS 440) - Seite / Page 15

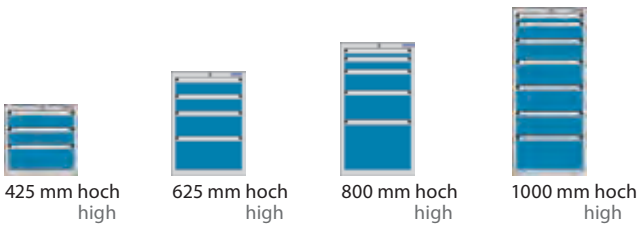

Breite / Width 565 mm x Tiefe / Depth 728 mm (RS 565) - Seite / Page 21

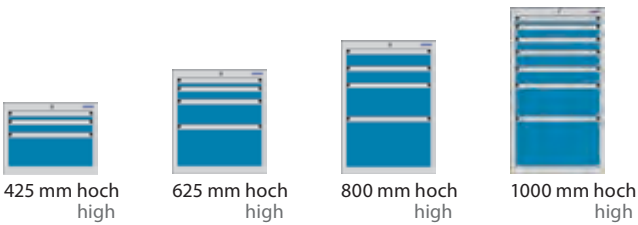

Breite / Width 576 mm x Tiefe / Depth 610 mm (RS 576) - Seite / Page 29



Breite / Width 718 mm x Tiefe / Depth 728 mm (RS 717) - Seite / Page 37

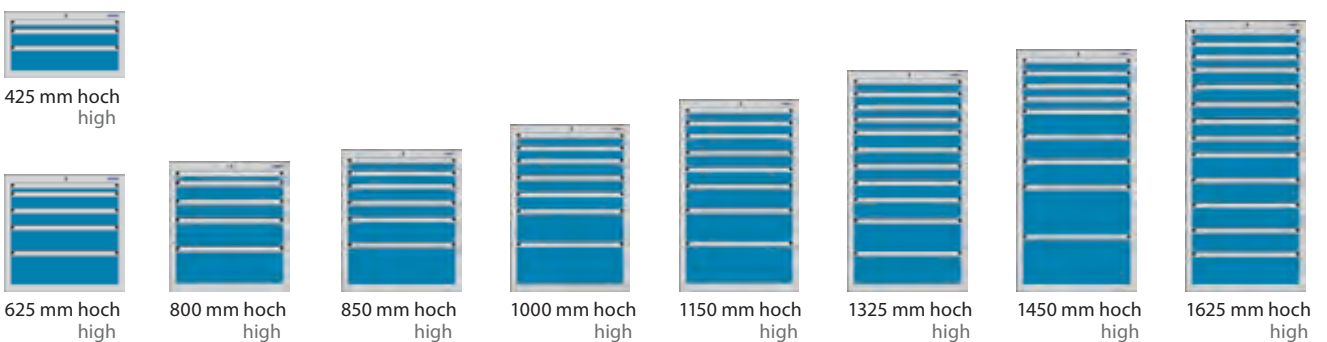

# Schubladenschränke | Varianten

## Drawer cabinets | Versions

Breite / Width 990 mm x Tiefe / Depth 806 mm (RS 1000) - Seite / Page 47



1000 mm hoch  
high



1450 mm hoch  
high

Breite / Width 1024 mm x Tiefe / Depth 728 mm (RS 1024) - Seite / Page 53



850 mm hoch  
high



1000 mm hoch  
high



1325 mm hoch  
high



1450 mm hoch  
high

Breite / Width 1196 mm x Tiefe / Depth 728 mm (RS 1196) - Seite / Page 59



850 mm hoch  
high



1000 mm hoch  
high



1325 mm hoch  
high



1450 mm hoch  
high

Breite / Width 1434 mm x Tiefe / Depth 728 mm (RS 1434) - Seite / Page 65



850 mm hoch  
high

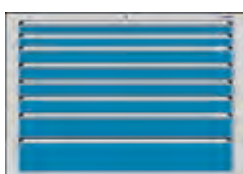

1000 mm hoch  
high

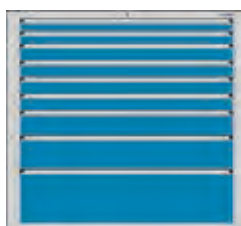

1325 mm hoch  
high

# Schubladenschränke | Ihr Vorteil

## Drawer cabinets | Your benefit

### Sicherheit / Safety



- Geprüfte Sicherheit (GS-Siegel)
- Griffleisten stehen nicht hervor, sondern schließen mit dem Gehäuse frontbündig ab.
- Schubladensperre mit dreifacher Sicherheit: Zentralverschluss, Einzelschubladensperre und Schubladen-Einzelverriegelung bei fahrbaren Lösungen
- Mechanisches Schließsystem: Gleich- oder verschiedenschließend
- Elektronisches Schließsystem mit Funktransponder, Pin, Barcode, RFID oder Magnetkarte (Option)
- Computergestützte Bestandsverwaltung über PC (Option)
- Integration in die bestehende EDV-Landschaft (Option)
- Automatisierte Zugriffs- und Entnahmeprotokollierung (Option)

- GS - safety (GS mark)
- Handle strips do not protrude but are flush with the casing at the front
- Drawer locking with triple security mechanism: central lock, individual drawer locking and individual drawer latch for mobile solutions
- Mechanical locking system: simultaneous or varied locking
- Electronic locking system with radio transponder, pin, barcode, RFID or magnetic card (optional)
- Computer-aided inventory management via PC (optional)
- Integration in the existing EDP environment (optional)
- Automatic access- and removal log (optional)



### Flexibilität / Flexibility

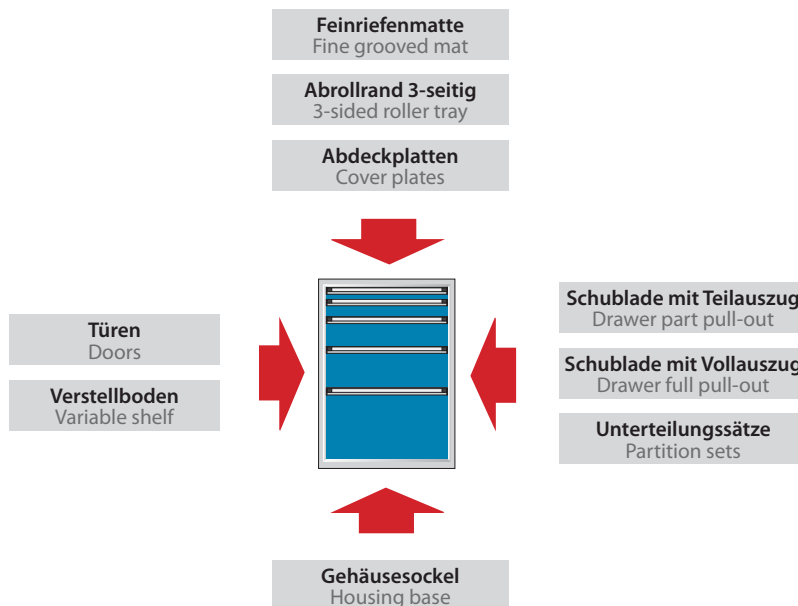

- Funktion und Ausstattung modular erweiterbar
- Schrankgehäuse unterschiedlicher Breite, Tiefe und Höhe
- Stationär oder fahrbar
- Schubladen oder Türen
- Teil- oder Vollauszug
- Konstantes Raster in Korpus und Schublade erleichtern die

- Function and accessories can be modular enhanced
- Cabinet housing with varying width, depth and height
- Stationary or mobile
- Drawers or doors
- Part- or full pull-out
- Consistent grid in casing and drawer make a



+32 (0)9 232 06 78



INFO@AWP.BE



DESTELBERGEN



# Schubladenschränke | Ihr Vorteil

## Drawer cabinets | Your benefit



### Qualität / Quality



- |  |   |
|--|---|
| <ul style="list-style-type: none"> <li>■ 10 Jahre Garantie</li> <li>■ Verwindungssteifes Gehäuse</li> <li>■ Maximale Gehäusetragkraft bis zu 2 Tonnen</li> <li>■ 85 %-Teilauszug mit maximal 100 kg Tragkraft je Schublade</li> <li>■ 100 %-Vollauszug mit maximal 200 kg Tragkraft je Schublade</li> <li>■ ISO 9001:2008 zertifiziert</li> <li>■ Made in Germany</li> </ul> | <ul style="list-style-type: none"> <li>■ 10-year warranty</li> <li>■ Torsion-resistant housing</li> <li>■ Maximum casing load-bearing capacity up to 2 tons</li> <li>■ 85 % part pull-out with maximum 100 kg load-bearing capacity per drawer</li> <li>■ 100 % full pull-out with maximum 200 kg load-bearing capacity per drawer</li> <li>■ ISO 9001:2008 certified</li> <li>■ Made in Germany</li> </ul> |
|--|---|

### Effizienz & Ergonomie / Efficiency and ergonomics



- |   |  |
|---|--|
| <ul style="list-style-type: none"> <li>■ Schubladengriffe ergonomisch geformt, auch mit Arbeitshandschuhen zu bedienen.</li> <li>■ Griffleisten mit Beschriftungsstreifen</li> <li>■ Etiketten für Lagerkästen, Mulden und Trennwände</li> <li>■ Schlitz- und Trennwände</li> <li>■ Lagerkastensätze</li> <li>■ Muldensätze</li> <li>■ AQURADO® Modulares Ordnungssystem</li> <li>■ Antirutschmatte, damit alles da bleibt, wo es hingehört.</li> </ul> | <ul style="list-style-type: none"> <li>■ Drawer handles are ergonomically formed, can be gripped with work gloves</li> <li>■ Handle ledges with label strips</li> <li>■ Labels for storage boxes, troughs and dividers</li> <li>■ Slotted panels and dividers</li> <li>■ Storage box sets</li> <li>■ Trough sets</li> <li>■ AQURADO® modular organization system</li> <li>■ Anti-skid mat keeps everything in place</li> </ul> |
|---|--|

# Schubladenschränke | Allgemeine Produktmerkmale

Drawer cabinets

General product characteristics

## Schrankgehäuse / Cabinet housings



- Durch Vorderrahmen verstärkte, äußerst steife Stahlblechkonstruktion, maximale Gehäusetragkraft 2 Tonnen
  - Raster 25 mm, für den wahlweisen Einbau von Verstellböden oder Schubladen mit unterschiedlichen Blendenhöhen
  - Griffleisten schließen mit dem Gehäuse frontbündig ab
- Front frame reinforced, extremely rigid sheet steel construction, maximum housing load-bearing capacity 2 tons
  - Grid 25 mm for the optional installation of adjustable shelf panels or drawers with varying drawer fronts
  - Handle strips are flush with the casing in the front

## Schubladen / Drawers



- Bis zu 10 verschiedene Schubladenblendenhöhen für individuelle Bedürfnisse: 50, 75, 100, 125, 150, 175, 200, 250, 300 und 400 mm
  - Schubladenboden gelocht (Ø 3,2 mm) am Korpusboden zum Anschrauben von Schlitz- und Trennwänden im 17 mm Raster
  - Schubladenwände innen mit eingepressten Stegen und Schlitz im 17 mm Raster für flexible Schubladeneinteilungsmöglichkeiten.
- up to 10 different drawer front heights according to individual requirements: 50, 75, 100, 125, 150, 175, 200, 250, 300 and 400 mm
  - Drawer bottom plate punched (Ø 3,2 mm) at body floor plate for screwing on slotted- and partition walls in 17 mm grid
  - inner drawer walls with pressed-in supports and slots in 17 mm grid for flexible drawer arrangement possibilities

## Schubladenführung / Drawer guidance



- Leichtgängige Schubladenführung mit Präzisions-Kugellagern
  - Teil- und Vollauszug beliebig kombinierbar
  - Laufschiene sind seitlich gesteckt
  - Metallkugellager für hohe Belastung und lange Lebensdauer
- Smooth-running drawer guidance with precision ball bearings
  - Part- and full pull-out combination according to preferences
  - Running rails attached at the side
  - Metal ball bearings for high strain and long durability

## Schubladengriffe / Drawer handles



- Eloxierte Aluminium-Griffleisten
  - Alle Schubladengriffe sind, zur Vermeidung von Verletzungen, mit Endkappen aus strapazierfähigem Kunststoff versehen
  - Beschriftungsstreifen aus Papier mit schützendem Folienstreifen ermöglichen das schnelle Auffinden des Schubladeninhalts
  - Ergonomisch geformte Griffleisten sind auch mit Arbeitshandschuhen zu bedienen
- Anodized aluminum handle strips
  - All drawer handles are equipped with end caps made of durable plastic to prevent injuries
  - Label strips made of paper with protective foil strips make it possible to quickly locate drawer contents
  - Ergonomically formed handle ledges can also be easily gripped with work gloves

## Schubladen Teilauszug / Drawer part pull-out



- 85 %-Teilauszug
- Bis zu 100 kg Tragkraft
- Nachträgliches Umrüsten von Teil- auf Vollauszug möglich
- 85 % part pull-out
- Up to 100 kg load-bearing capacity
- Subsequent retrofitting possible from part- to full pull-out

## Schubladen Vollauszug / Drawer full pull-out



- 100 % Vollauszug
- Bis zu 200 kg Tragkraft
- 100 % full pull-out
- Up to 200 kg load-bearing capacity

# Schubladenschränke | Allgemeine Produktmerkmale

## Drawer cabinets | General product characteristics

### Auszugssperre - Kippschutz / Pull-out locking - Tilt protection



- Triple safety mechanism: central lock, drawer pull-out locking (standard), individual drawer lock
  - Drawer pull-out locking: When one drawer is open, the pull-out locking prevents other drawers from being opened. This reduces the risk of tipping the cabinet over
  - Individual drawer lock: additional latch (see illustration) for mobile models
- Dreifache Sicherheit: Zentralverschluss, Schubladen-Ausziehsperre (Standard), Schubladen-Einzelverriegelung
  - Schubladen-Ausziehsperre: Wenn eine Schublade geöffnet ist, verhindert die Schubladen-Ausziehsperre, dass weitere Schubladen geöffnet werden können. Dadurch wird die Kippgefahr verringert
  - Schubladen-Einzelverriegelung: Zusatzriegel (siehe Abbildung) für fahrbare Modelle

### Flügeltüren / Wing doors



- Öffnungswinkel 180 Grad für mehr Übersicht und optimale Zugängigkeit
- Versenkter Drehgriff mit Zylinderschloss schützt das Schloss vor Beschädigung und kann auch mit Schutzhandschuhen bequem geöffnet werden
- Opening angle 180 degrees for a better overview and optimal accessibility
- Recessed turning handle with cylinder lock protects the lock from damage and can also be easily gripped with work gloves

### Mobilität / Mobility



- Ergonomisch geformte, kompakte Griffe
- Fahrwerk aus verwindungssteifen Winkelprofile, fixiert durch eine Traverse
- 2 Lenkrollen mit Feststeller und 2 Bockrollen mit bis zu 750 kg Fahrwerkstragkraft
- Ergonomically formed compact handles
- chassis made of torsion-resistant angle sections, fixed with a crossbar
- 2 swivel castors that can be locked in place and 2 fixed castors with up to 750 kg chassis capacity

### Schubladeneinteilungsmöglichkeiten / Drawer arrangement possibilities



- Lagerkastensätze
- Storage box sets



- Schlitzwandsätze
- Slotted panel sets



- Muldensätze
- Trough sets



- AQURADO® Modulares Ordnungssystem
- AQURADO® modular organization system

**Nutzen Sie das umfangreiche Schubladeneinteilungssortiment von LOKOMA. Teilen Sie Ihre Schubladen ganz nach Ihren individuellen Wünschen ein. Mehr dazu finden Sie im entsprechenden Kapitel.**

Benefit from the extensive drawer arrangement assortment by LOKOMA. Divide your drawers according to individual preference. You may find more in the respective chapter



# Schubladenschränke | Schließsysteme

## Drawer cabinets | Locking systems

### Mechanisches Schließsystem / Mechanical locking system



- Der Zentralverschluss bewirkt den gleichzeitigen Verschluss von mehreren Schubladen
- Drehzylinderschloss mit 2 Schlüsseln
- Lebensdauer ausgelegt auf 30.000 Schließungen
- Wahlweise gleich- oder verschiedenschließend



- Central locking ensures simultaneous locking of several drawers
- Rotary cylinder lock with 2 keys
- Service life designed for 30,000 lockings
- Optionally separately or simultaneously lockable

### Varianten für mechanische Schließung

Variants for mechanical locking:

Übergeordneter Hauptschlüssel  
Main key system

Verschiedenschließend (Standard)  
Separately lockable (standard)

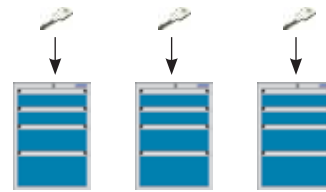

Gleichschließend (Bitte bei Bestellung angeben.)  
Simultaneously lockable (please indicate when ordering)

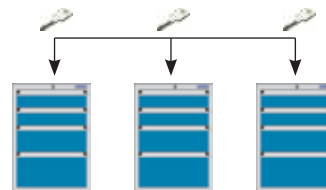

### Elektronische Schließsysteme / Electronic locking systems



- Öffnen und Schließen durch 4-6-stelligen UserCode
- Softwareunterstützte Programmierung durch SystemKeys
- Hardwareunterstützte Programmierung durch Programmier-Set
- Optische und akustische Meldungen
- Kapazitive, nicht abnutzbare Tastatur
- Zeitmodelle Gültigkeitsbeginn, Gültigkeitsende und Zeitzonen
- Überwachung Batteriezustand / Batteriezustand kontrollierbar
- Frei programmierbare, veränderbare Schließberechtigungen
- MasterCode-Funktion zum Öffnen und Schließen
- Konfigurierbare MasterKey-Funktion
- Sperrzeit gegen unberechtigte Öffnungsversuche
- Konfigurierbarer Schließprotokollspeicher
- Geprüfte Aufbruchsicherheit
- Neu- und Umprogrammierung ist jederzeit kurzfristig und problemlos möglich.

- Open and close using 4-6 digit user code
- Software-assisted programming using system keys
- Hardware-assisted programming using a programming kit
- Visual messages and sounds
- Capacitive, hard-wearing keypad
- Time model validity end and time zones
- Battery status monitoring / battery status can be checked
- Fully programmable; access authorisations can be changed
- Master code function to open and close
- Configurable master key function
- Time lock to prevent unauthorised attempts at opening
- Configurable locking log memory
- Proven burglar-proof capacity
- New and re-programming is possible at short notice at any time and without any problems

# Schubladenschränke | Breite / Width 440 mm x Tiefe / Depth 610 mm

## Drawer cabinets | Produktmerkmale / Product characteristics

### Merkmale / Characteristics



### Schrankgehäusehöhen / Nutzhöhen für den Einbau von Schubladen

#### Cabinet housing heights / Effective heights for the assembly of drawers



### Nutzmaße der Schubladen / Effective size of drawers

Blendenhöhe der Schubladen (mm) Drawer face height (mm)	Nutzhöhe der Schubladen (mm) Drawer effective height (mm)	Nutzfläche (Breite x Tiefe mm) Effective space (Width x Depth mm)
50	35	340 x 526
75	60	340 x 526
100	85	340 x 526
125	110	340 x 526
150	135	340 x 526
175	160	340 x 526
200	185	340 x 526
250	235	340 x 526
300	285	340 x 526

#### Nutzfläche im 17 mm Raster Effective space in 17 mm grid

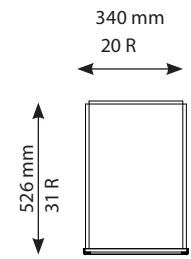

Raster (17 mm je Rastereinheit) erleichtern es Ihnen, die passenden Lagerkästen, Schlitzwand-sätze oder Muldensätze für die Schubladengröße zusammen zu stellen.

Die Summe der Schubladenblendenhöhen muss der Nutzhöhe des Schrankgehäuses entsprechen.  
The sum of all drawer face heights must be equal to the useable front height of the cabinet housing.

Grids (17 mm per unit) make it easier for you to arrange the matching storage boxes, slotted panel sets and trough sets for your drawer size.

# Schubladenschränke | Breite / Width 440 mm x Tiefe / Depth 610 mm

## Drawer cabinets | Bestellbeispiele / Order examples

### Höhe / Height 425 mm (Nutzhöhe / eff. height 350 mm)



50 Teilauszug / Part pull-out  
100  
200

3x



100  
100  
150

3x

Auszug / Pullout	Best.-Nr. / Ord.-No.
Teilauszug / Part pull-out	00.07.9245
Vollauszug (außer Blendenhöhe 50 mm) Full pull-out (except face height 50 mm)	00.07.9246

Auszug / Pull-out	Best.-Nr. / Ord.-No.
Teilauszug / Part pull-out	00.07.9247
Vollauszug / Full pull-out	00.07.9248

### Höhe / Height 625 mm (Nutzhöhe / eff. height 550 mm)



50 Teilauszug / Part pull-out  
100  
150  
250

4x



100  
100  
150  
200

4x

Auszug / Pullout	Best.-Nr. / Ord.-No.
Teilauszug / Part pull-out	00.07.9222
Vollauszug (außer Blendenhöhe 50 mm) Full pull-out (except face height 50 mm)	00.07.9208

Auszug / Pull-out	Best.-Nr. / Ord.-No.
Teilauszug / Part pull-out	00.07.9209
Vollauszug / Full pull-out	00.07.9210

### Höhe / Height 625 mm (Nutzhöhe / eff. height 550 mm)



75  
75  
100  
150  
150

5x



75  
75  
100  
100  
100  
100

6x

Auszug / Pull-out	Best.-Nr. / Ord.-No.
Teilauszug / Part pull-out	00.07.9211
Vollauszug / Full pull-out	00.07.9212

Auszug / Pull-out	Best.-Nr. / Ord.-No.
Teilauszug / Part pull-out	00.07.9249
Vollauszug / Full pull-out	00.07.9250

**Schubladerschränke**

Drawer cabinets

**Breite / Width 440 mm x Tiefe / Depth 610 mm**

Schubladeneinteilungssätze / Drawer partitioning sets

**Höhe / Height 800 mm (Nutzhöhe / eff. height 725 mm)**75  
75  
75  
100  
100  
150  
150

7x

50 Teilauszug / Part pull-out  
100  
125  
150  
300

5x

Auszug / Pull-out	Best.-Nr. / Ord-No.
Teilauszug / Part pull-out	00.07.9239
Vollauszug / Full pull-out	00.07.9240

Auszug / Pull-out	Best.-Nr. / Ord-No.
Teilauszug / Part pull-out	00.07.9201
Vollauszug (außer Blendenhöhe 50 mm) Full pull-out (except face height 50 mm)	00.07.9202

**Höhe / Height 800 mm (Nutzhöhe / eff. height 725 mm)**50 Teilauszug / Part pull-out  
75  
200  
200  
200

5x

125  
125  
175  
300

4x

Auszug / Pull-out	Best.-Nr. / Ord-No.
Teilauszug / Part pull-out	00.07.9203
Vollauszug (außer Blendenhöhe 50 mm) Full pull-out (except face height 50 mm)	00.07.9204

Auszug / Pull-out	Best.-Nr. / Ord-No.
Teilauszug / Part pull-out	00.07.9205
Vollauszug / Full pull-out	00.07.9206

**Höhe / Height 1000 mm (Nutzhöhe / eff. height 925 mm)**50 Teilauszug / Part pull-out  
100  
125  
150  
150  
150  
200

7x

100  
100  
125  
200  
200  
200

6x

Auszug / Pull-out	Best.-Nr. / Ord-No.
Teilauszug / Part pull-out	00.07.9262
Vollauszug (außer Blendenhöhe 50 mm) Full pull-out (except face height 50 mm)	00.07.9263

Auszug / Pull-out	Best.-Nr. / Ord-No.
Teilauszug / Part pull-out	00.07.9264
Vollauszug / Full pull-out	00.07.9265

# Schubladenschränke | Breite / Width 440 mm x Tiefe / Depth 610 mm

## Drawer cabinets | Zubehör / Accessories

### Abrollrand / 3-sided roller tray



- 3-seitig aufgekantetes Stahlblech, gefalzt
- Vernietet
- 3-sided roller tray, folded steel sheet
- Riveted

Breite / Width x Tiefe / Depth x Höhe / Height (mm)	Best.-Nr. / Ord.-no.
440 x 610 x 30	00.07.9194

### Abdeckplatten / Cover plates



- Lichtgraue Melaminharzbeschichtung
- Allseitig mit stoßfestem Kunststoffumleimer
- Verschraubbar
- Light-grey melamin resin coating
- All side with shockproof synthetic edging
- Can be screwed in

Breite / Width x Tiefe / Depth x Höhe / Height (mm)	Best.-Nr. / Ord.-no.
440 x 610 x 19	34.07.9192

### Feinriefenmatte / Fine grooved mat

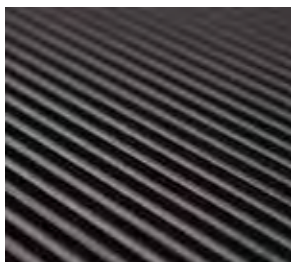

- Qualität SBR
- Schwarz
- Auch als separate Auflage nutzbar
- Quality SBR
- Black
- Can be used separately

Breite / Width x Tiefe / Depth x Höhe / Height (mm)	Best.-Nr. / Ord.-no.
437 x 609 x 3	35.07.9195

### Gehäuse-Sockel / Housing base



- Gehäusesockel als Höhenausgleich, Höhe: 50 mm oder 100 mm, Tiefe 610 mm
- Housing base to balance height, height: 50 mm oder 100 mm, depth 610 mm

Sockel Base	Höhe (mm) Height (mm)	Breite (mm) Width (mm)	Best.-Nr. Ord.-no.
Gehäuse-Sockel Housing base	50	440	00.07.9189
Gehäuse-Sockel Housing base	100	440	00.07.9190



## Schubladerschränke | Breite / Width 440 mm x Tiefe / Depth 610 mm

### Drawer cabinets | Schubladeneinteilungsätze / Drawer partitioning sets

#### Schlitzwandsätze / Slotted panel sets



- 1 Schlitzwand 525 mm
- 2 Trennwände 167 mm 10 R
- 1 Slotted panel 525 mm
- 2 Dividers 167 mm 10 R



- 2 Schlitzwände 525 mm
- 1 Trennwand 99 mm 6 R
- 2 Trennwände 116 mm 7 R
- 2 Slotted panels 525 mm
- 1 Divider 99 mm 6 R
- 2 Dividers 116 mm 7 R

Blendenhöhen / Face heights	Best.-Nr. / Ord.-no.
50 mm	00.07.9251
75 mm	00.07.9252
100, 125 mm	00.07.9253
150, 175 mm	00.07.9254
200 mm	00.07.9255

Blendenhöhen / Face heights	Best.-Nr. / Ord.-no.
50 mm	00.07.9256
75 mm	00.07.9257
100, 125 mm	00.07.9258
150, 175 mm	00.07.9259

#### Einsatzkastensatz / Insert boxes set

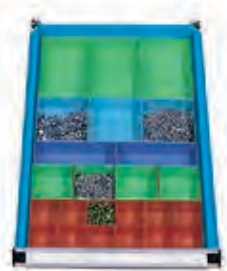

- 12 Einsatzkästen EK 1 54 x 54 x 45 rot
- 4 Einsatzkästen EK 5 75 x 81 x 45 grün
- 2 Einsatzkästen EK 4 54 x 162 x 45 blau
- 3 Einsatzkästen EK 6 108 x 108 x 45 blau
- 3 Einsatzkästen EK 7 108 x 162 x 45 grün

- 12 insert boxes EK 1 54 x 54 x 45 red
- 4 insert boxes EK 5 75 x 81 x 45 green
- 2 insert boxes EK 4 54 x 162 x 45 blue
- 3 insert boxes EK 6 108 x 108 x 45 blue
- 3 insert boxes EK 7 108 x 162 x 45 green

Blendenhöhe / Face height	Best.-Nr. / Ord.-no.
75 mm	01.07.9261

#### Muldensatz aus Aluminium / Aluminum troughs



- 6 Mulden 518 x 55 mm
- 24 Steckbleche 43 mm breit
- Muldenhöhe 35 mm
- 6 troughs 518 x 55 mm
- 24 metal inserts 43 mm wide
- Trough height 35 mm

Blendenhöhe / Face height	Best.-Nr. / Ord.-no.
75 mm	00.07.9271

#### Zellkautschuk-Einlagen / Foam rubber inserts



- Zellkautschuk-Einlage für die Lagerung empfindlicher Messzeuge und Lehren
- Qualität EPDM, schwarz
- Breite 338 mm x Tiefe 525 x Dicke 3 mm
- Für alle Blendenhöhen
- Foam rubber mat for storage of sensitive measuring tools and calipers
- Quality EPDM, black
- Width 338 mm x Depth 525 x Thickness 3 mm
- For all face heights



- Ablagefach für Messzeuge, verschiebbar
- Breite 329 mm x Tiefe 304 mm x Höhe 20 mm
- Storage tray for measuring tools, adjustable
- Width 329 mm x Depth 304 mm x Height 20 mm

Best.-Nr. / Ord.-no
27.07.9276

Blendenhöhen / Face heights	Best.-Nr. / Ord.-no.
75, 100, 125 mm	00.07.9280



RS  
440RS  
565RS  
576RS  
717RS  
1000RS  
1024RS  
1196RS  
1434Schubl-  
regal**Schubladenschränke** | Breite / Width 565 x Tiefe / Depth 728 mm

Drawer cabinets

Produktmerkmale / Product characteristics

## Merkmale / Characteristics



## Schrankgehäusehöhen / Nutzhöhen für den Einbau von Schubladen

Cabinet housing heights / Effective heights for the assembly of drawers

425/325 mm hoch  
high625/525 mm hoch  
high800/700 mm hoch  
high1000/900 mm hoch  
high

## Nutzmaße der Schubladen / Effective size of drawers

Blendenhöhe der Schubladen (mm) Drawer face height (mm)	Nutzhöhe der Schubladen (mm) Drawer effective height (mm)	Nutzfläche (Breite x Tiefe mm) Effective space (Width x Depth mm)
50	35	459 x 612
75	60	459 x 612
100	85	459 x 612
125	110	459 x 612
150	135	459 x 612
175	160	459 x 612
200	185	459 x 612
250	235	459 x 612
300	285	459 x 612

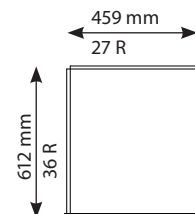
Nutzfläche im 17 mm Raster  
Effective space in 17 mm grid

Raster (17 mm je Rastereinheit) erleichtern es Ihnen, die passenden Lagerkästen, Schlitzwand-sätze oder Muldensätze für die Schubladengröße zusammen zu stellen.

Die Summe der Schubladenblendenhöhen muss der Nutzhöhe des Schrankgehäuses entsprechen.  
Beispiel: 9 x Blendenhöhe 50 mm + 1 x Blendenhöhe 75 mm = Nutzhöhe 525 mm  
The sum of all drawer face heights must be equal to the useable front height of the cabinet housing.  
Example: 9 x face height 50 mm + 1 x face height 75 mm = effective height 525 mm

Grids (17 mm per unit) make it easier for you to arrange the matching storage boxes, slotted panel sets and trough sets for your drawer size.



# Schubladenschränke

Drawer cabinets

**Breite / Width 565 x Tiefe / Depth 728 mm**

Bestellbeispiele / Order examples

## Höhe / Height 425 mm (Nutzhöhe / Eff. height 325 mm)



75  
100  
150

3x

Auszug/Pull out	Best.-Nr./Ord. no.
Teilauszug / Part pull-out	00.02.9502
Vollauszug / Full pull-out	00.02.9503

## Höhe / Height 625 mm (Nutzhöhe / Eff. height 525 mm)

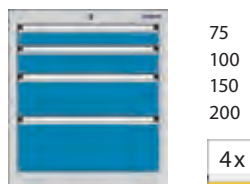

75  
100  
150  
200

4x

Auszug/Pull out	Best.-Nr./Ord. no.
Teilauszug / Part pull-out	00.02.9506
Vollauszug / Full pull-out	00.02.9507

## Höhe / Height 800 mm (Nutzhöhe / Eff. height 700 mm)

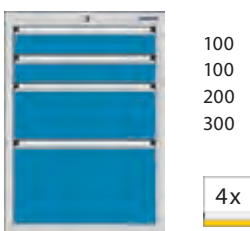

100  
100  
200  
300

4x

Auszug/Pull out	Best.-Nr./Ord. no.
Teilauszug / Part pull-out	00.02.9516
Vollauszug / Full pull-out	00.02.9517



100  
100  
150  
150  
200

5x

Auszug/Pull out	Best.-Nr./Ord. no.
Teilauszug / Part pull-out	00.02.9518
Vollauszug / Full pull-out	00.02.9519

## Höhe / Height 800 mm (Nutzhöhe / Eff. height 700 mm)

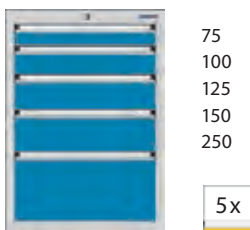

75  
100  
125  
150  
250

5x

Auszug/Pull out	Best.-Nr./Ord. no.
Teilauszug / Part pull-out	00.02.9526
Vollauszug / Full pull-out	00.02.9527

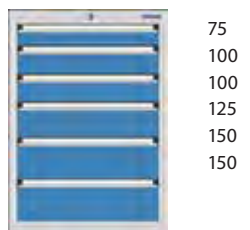

75  
100  
100  
125  
150  
150

6x

Auszug/Pull out	Best.-Nr./Ord. no.
Teilauszug / Part pull-out	00.02.9554
Vollauszug / Full pull-out	00.02.9555

**Schubladenschränke** | Breite / Width 565 x Tiefe / Depth 728 mm

Drawer cabinets | Bestellbeispiele / Order examples

Höhe / Height 1000 mm (Nutzhöhe / Eff. height 900 mm)

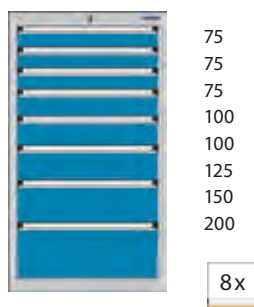

8x

Auszug/Pull out	Best.-Nr./Ord. no.
Teilauszug / Part pull-out	00.02.9564
Vollauszug / Full pull-out	00.02.9565

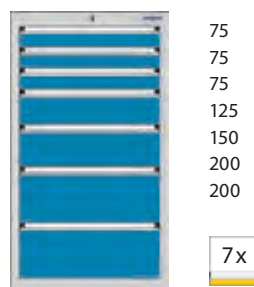

7x

Auszug/Pull out	Best.-Nr./Ord. no.
Teilauszug / Part pull-out	00.02.9534
Vollauszug / Full pull-out	00.02.9535

Fahrbar / Mobile: Gehäusehöhe / Height 625 mm, Nutzhöhe / Eff. height 525 mm, Gesamthöhe mit Rollen / Overall height with castors 782 mm

(Rollen / Castors Ø 100 mm) Gesamtgew. / Total weight max. 450 kg



3x

- Abrollrand mit Feinriefenmatte
- Jede Schublade mit Einzelverriegelung
- 2 Lenk- und 2 Bockrollen
- Roller tray with fine grooved mat
- Drawers with individual drawer interlock
- 2 swivel castors and 2 fixed castors

Auszug / Pull-out	Best.-Nr. / Ord.-no.
Teilauszug / Part pull-out	00.02.9508
Vollauszug / Full pull-out	00.02.9509

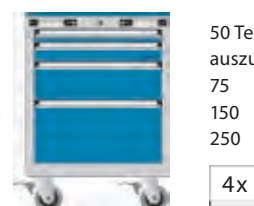

4x

- Abrollrand mit Feinriefenmatte
- Jede Schublade mit Einzelverriegelung
- 2 Lenk- und 2 Bockrollen
- Roller tray with fine grooved mat
- Drawers with individual drawer interlock
- 2 swivel castors and 2 fixed castors

Auszug / Pull-out	Best.-Nr. / Ord.-no.
Teilauszug / Part pull-out	00.02.9512
Vollauszug (außer Blendenhöhe 50 mm) Full pull-out (ex. face height 50 mm)	00.02.9513

Fahrbar / Mobile: Gehäusehöhe / Height 800 mm, Nutzhöhe / Eff. height 700 mm, Gesamthöhe mit Rollen / Overall height with castors 986 mm

(Rollen / Castors Ø 125 mm) Gesamtgew. / Total weight max. 750 kg

50 Teil-  
auszug75  
75  
75  
100  
125  
200

- Abrollrand mit Feinriefenmatte
- Jede Schublade mit Einzelverriegelung
- 2 Lenk- und 2 Bockrollen
- Roller tray with fine grooved mat
- Drawers with individual drawer interlock
- 2 swivel castors and 2 fixed castors

7x

Auszug / Pull-out	Best.-Nr. / Ord.-no.
Teilauszug / Part pull-out	00.02.9528
Vollauszug (außer Blendenhöhe 50 mm) Full pull-out (ex. face height 50 mm)	00.02.9529



5x

- Abrollrand mit Feinriefenmatte
- Jede Schublade mit Einzelverriegelung
- 2 Lenk- und 2 Bockrollen
- Roller tray with fine grooved mat
- Drawers with individual drawer interlock
- 2 swivel castors and 2 fixed castors

Auszug / Pull-out	Best.-Nr. / Ord.-no.
Teilauszug / Part pull-out	00.02.9530
Vollauszug / Full pull-out	00.02.9531

# Schubladenschränke | Breite / Width 565 x Tiefe / Depth 728 mm

## Drawer cabinets | Zubehör / Accessories

### Abrollrand / 3-sided roller tray



- 3-seitig aufgekantetes Stahlblech, gefalzt
- Vernietet
- 3-sided roller tray, folded steel sheet
- Riveted

Breite / Width x Tiefe / Depth x Höhe / Height (mm)	Best.-Nr. / Ord.-no.
565 x 728 x 30	00.02.8310

### Abdeckplatten / Cover plates



- Lichtgraue Melaminharzbeschichtung
- Allseitig mit stoßfestem Kunststoffumleimer
- Verschraubbar
- Light-grey melamin resin coating
- All side with shockproof synthetic edging
- Can be screwed in

Breite / Width x Tiefe / Depth x Höhe / Height (mm)	Best.-Nr. / Ord.-no.
565 x 728 x 19	34.02.9541

### Feinriefenmatte / Fine grooved mat



- Qualität SBR
- Schwarz
- Auch als separate Auflage nutzbar
- Quality SBR
- Black
- Can be used separately

Breite / Width x Tiefe / Depth x Höhe / Height (mm)	Best.-Nr. / Ord.-no.
562 x 727 x 3	35.02.9542

### Gehäuse-Sockel / Housing base



- Gehäusesockel als Höhenausgleich, Höhe: 50 mm oder 100 mm, Tiefe 728 mm
- Housing base to balance height, height: 50 mm oder 100 mm, depth 728 mm

Sockel Base	Höhe (mm) Height (mm)	Breite (mm) Width (mm)	Best.-Nr. Ord.-no.
Gehäuse-Sockel Housing base	50	565	00.02.8311
Gehäuse-Sockel Housing base	100	565	00.02.8312



## Schubladenschränke | Breite / Width 565 x Tiefe / Depth 728 mm

Drawer cabinets | Schubladeneinteilungssätze / Drawer partitioning sets

### Schlitzwandsätze / Slotted panel sets

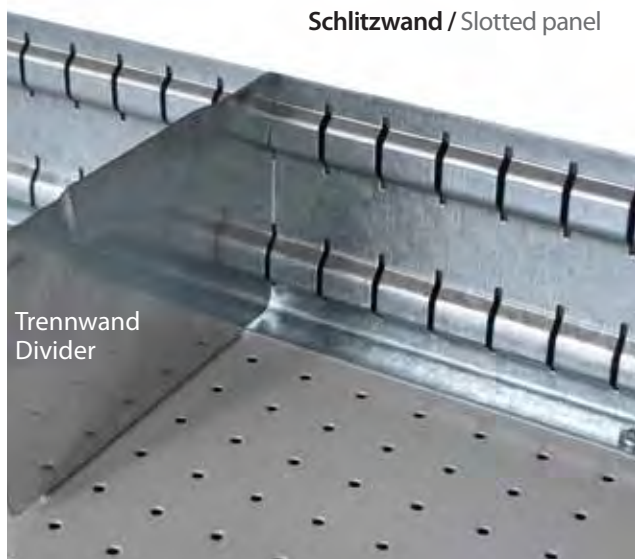

Schlitzwand / Slotted panel



- 1 Schlitzwand 610 mm, 36 R
- 2 Trennwände 201 mm, 12 R
- 2 Trennwände 252 mm, 15 R
- 1 Slotted panel 610 mm, 36 R
- 2 Dividers 201 mm, 12 R
- 2 Dividers 252 mm, 15 R

Blendenhöhen / Face heights	Best.-Nr. / Ord.-no.
50 mm	00.02.9598
75 mm	00.02.9599
100, 125 mm	00.02.9600
150, 175 mm	00.02.9601
200 mm	00.02.9602



- 2 Schlitzwände 610 mm, 36 R
- 9 Trennwände 150 mm, 9 R
- 2 Slotted panels 610 mm, 36 R
- 9 Dividers 150 mm, 9 R

Blendenhöhen / Face heights	Best.-Nr. / Ord.-no.
50 mm	00.02.9603
75 mm	00.02.9604
100, 125 mm	00.02.9605
150, 175 mm	00.02.9606

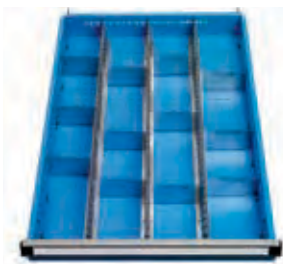

- 3 Schlitzwände 610 mm, 36 R
- 9 Trennwände 116 mm, 7 R
- 3 Trennwände 99 mm, 6 R
- 3 Slotted panels 610 mm, 36 R
- 9 Dividers 116 mm, 7 R
- 3 Dividers 99 mm, 6 R

Blendenhöhen / Face heights	Best.-Nr. / Ord.-no.
50 mm	00.02.9607
75 mm	00.02.9608
100, 125 mm	00.02.9609
150, 175 mm	00.02.9610

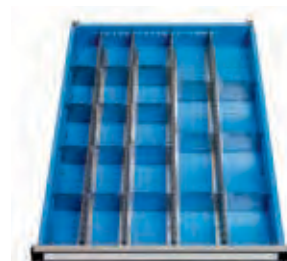

- 4 Schlitzwände 610 mm, 36 R
- 10 Trennwände 99 mm, 6 R
- 4 Trennwände 82 mm, 5 R
- 4 Trennwände 65 mm, 4 R
- 4 Slotted panels 610 mm, 36 R
- 10 Dividers 99 mm, 6 R
- 4 Dividers 82 mm, 5 R
- 4 Dividers 65 mm, 4 R

Blendenhöhen / Face heights	Best.-Nr. / Ord.-no.
50 mm	00.02.9611
75 mm	00.02.9612
100, 125 mm	00.02.9613

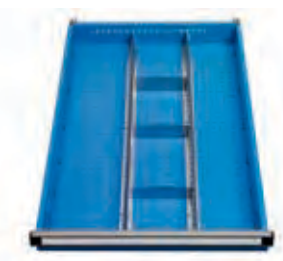

- 2 Schlitzwände 610 mm, 36 R
- 3 Trennwände 150 mm, 9 R
- 2 Slotted panels 610 mm, 36 R
- 3 Dividers 150 mm, 9 R

Blendenhöhen / Face heights	Best.-Nr. / Ord.-no.
50 mm	00.02.9614
75 mm	00.02.9615
100, 125 mm	00.02.9634
150, 175 mm	00.02.9635

# Schubladenschränke

Drawer cabinets

**Breite / Width 565 x Tiefe / Depth 728 mm**

Schubladeneinteilungsätze / Drawer partitioning sets

## Muldensätze aus Polypropylen-Kunststoff / Polypropylene troughs

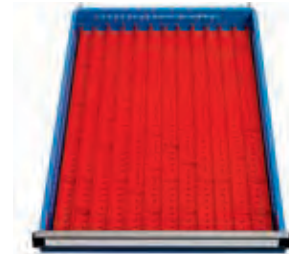

- 12 Mulden 4-teilig
- 50 Steckwände 4-teilig
- 12 troughs four-part
- 50 trough inserts four-part

Blendenhöhe / Face height	Best.-Nr. / Ord.-no.
50 mm , 75 mm	00.02.9626



- 4 Mulden 4-teilig
- 20 Steckwände 4-teilig
- 8 Mulden 3-teilig
- 10 Steckwände 3-teilig
- 4 troughs four-part
- 20 trough inserts four-part
- 8 troughs three-part
- 10 trough inserts three-part

Blendenhöhe / Face height	Best.-Nr. / Ord.-no.
75 mm	00.02.9628



- 4 Mulden 3-teilig
- 20 Steckwände 3-teilig
- 8 Mulden 2-teilig
- 10 Steckwände 2-teilig
- 4 troughs three-part
- 20 trough inserts three-part
- 8 troughs two-part
- 10 trough inserts two-part

Blendenhöhe / Face height	Best.-Nr. / Ord.-no.
75 mm	00.02.9630

## Steckwände/Etiketten / Archiving labels & clear plastic strips

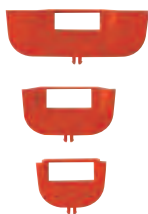

- Steckwände mit Beschriftungsfeld
- Etiketten/Klarsichtfolie: Breite 27,5 x Höhe 12,5 mm
- Trough inserts with labelling space
- Labels/Clear plastic strips: Width 27,5 x Height 12,5 mm

Ausführung / Characteristics	Best.-Nr. / Ord.-no.
73 mm breit / wide	00.02.1834
48 mm breit / wide	00.02.1832
36 mm breit / wide	00.02.1830
Beschriftungs-Etiketten (VE 25 St) Archiving labels	00.02.1841
Klarsichtfolie für Etiketten (VE 25 St) Clear plastic strips for archiving labels	00.02.1846

## Muldensatz aus Aluminium / Aluminum troughs



- 3 Mulden 602 x 55 mm
- 4 Mulden 602 x 73 mm
- 15 Steckbleche 43 mm
- 20 Steckbleche 62 mm
- Muldenhöhe 35 mm
- 3 troughs 602 x 55 mm
- 4 troughs 602 x 73 mm
- 15 metal insert 43 mm
- 20 metal insert 62 mm
- troughs height 35 mm

Blendenhöhe / Face height	Best.-Nr. / Ord.-no.
75 mm	00.02.9629

## Schubladenschränke | Breite / Width 565 x Tiefe / Depth 728 mm

### Drawer cabinets | Schubladeneinteilungssätze / Drawer partitioning sets

#### Lagerkastensätze / Insert boxes sets

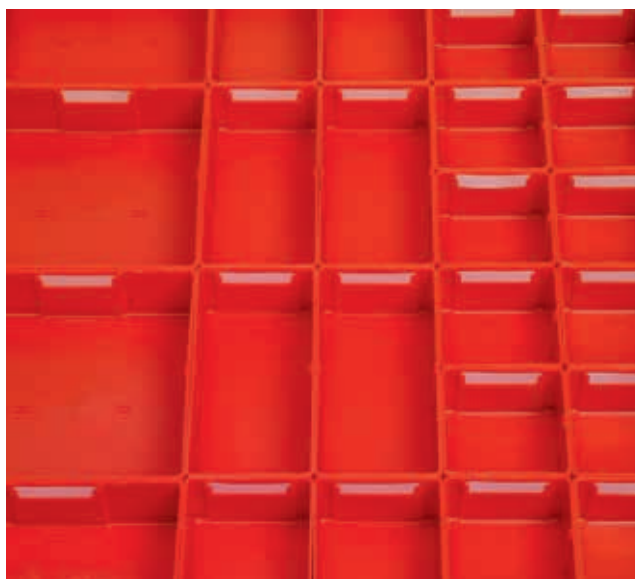

- 16 Einsatzkästen 75 x 75 x 26/46 mm
- 8 Einsatzkästen 150 x 75 x 26/46 mm
- 4 Einsatzkästen 150 x 150 x 26/46 mm
- 16 insert boxes 75 x 75 x 26/46 mm
- 8 insert boxes 150 x 75 x 26/46 mm
- 4 insert boxes 150 x 150 x 26/46 mm

Blendenhöhen / Face heights	Best.-Nr. / Ord.-no.
50 mm	00.02.9622
75 mm	00.02.9623



- 16 Einsatzkästen 75 x 75 x 26/46 mm
- 16 Trennwände einsteckbar
- 16 Einsatzkästen 75 x 75 x 26/46 mm
- 4 Einsatzkästen 150 x 75 x 26/46 mm
- 2 Einsatzkästen 150 x 150 x 26/46 mm
- 16 insert boxes 75 x 75 x 26/46 mm
- 16 Dividers are insertable
- 16 insert boxes 75 x 75 x 26/46 mm
- 4 insert boxes 150 x 75 x 26/46 mm
- 2 insert boxes 150 x 150 x 26/46 mm

Blendenhöhen / Face heights	Best.-Nr. / Ord.-no.
50 mm	00.02.9624
75 mm	00.02.9625

#### Zellkautschuk-Einlagen / Foam rubber inserts



- Zellkautschuk-Einlage für die Lagerung empfindlicher Messzeuge und Lehren
- Qualität EPDM, schwarz
- Breite 457 mm x Tiefe 610 x Dicke 3 mm
- Für alle Blendenhöhen

- Foam rubber insert for storing delicate measuring and gauges
- Quality EPDM, black
- Width 457 mm x Depth 610 x Thickness 3 mm
- For all face heights

Best.-Nr. / Ord.-no.
27.02.9631

#### AQRADO® - Modulares Ordnungssystem / Modular filing system



- AQRADO®-System bestehend aus: 16 Universalboxen, 3 Ausgleichsboxen, Klebepad, AQRADO®-Platte
- Breite 456 mm x Tiefe 600 mm x Höhe 52 mm
- AQRADO® system consisting of: 16 all-purpose boxes, 3 adjusting boxes, sticky pad, AQRADO® board
- Width 456 mm x Depth 600 mm x Height 52 mm

Blendenhöhen / Face heights	Best.-Nr. / Ord.-no.
Ab / From 75 mm	45.02.0072



- AQRADO®-System bestehend aus: 10 Universalboxen, 3 Ausgleichsboxen, Klebepad, AQRADO®-Platte
- Breite 456 mm x Tiefe 600 mm x Höhe 52 mm
- AQRADO® system consisting of: 10 all-purpose boxes, 3 adjusting boxes, sticky pad, AQRADO® board
- Width 456 mm x Depth 600 mm x Height 52 mm

Blendenhöhen / Face heights	Best.-Nr.
Ab / From 75 mm	45.02.0073



# Schubladenschränke | Breite / Width 576 x Tiefe / Depth 610 mm

## Drawer cabinets | Produktmerkmale / Product characteristics

### Merkmale / Characteristics



### Schrankgehäusehöhen / Nutzhöhen für den Einbau von Schubladen

#### Cabinet housing heights / Effective heights for the assembly of drawers

425/350 mm hoch high  
625/550 mm hoch high  
800/725 mm hoch high  
1000/925 mm hoch high

### Nutzmaße der Schubladen / Effective size of drawers

Blendenhöhe der Schubladen (mm) Drawer face height (mm)	Nutzhöhe der Schubladen (mm) Drawer effective height (mm)	Nutzfläche (Breite x Tiefe mm) Effective space (Width x Depth mm)
50	35	475 x 526
75	60	475 x 526
100	85	475 x 526
125	110	475 x 526
150	135	475 x 526
175	160	475 x 526
200	185	475 x 526
250	235	475 x 526
300	285	475 x 526

### Nutzfläche im 17 mm Raster Effective space in 17 mm grid

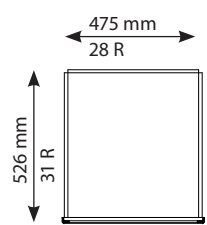

Raster (17 mm je Rastereinheit) erleichtern es Ihnen, die passenden Lagerkästen, Schlitzwand-sätze oder Muldensätze für die Schubladengröße zusammen zu stellen.

Die Summe der Schubladenblendenhöhen muss der Nutzhöhe des Schrankgehäuses entsprechen.  
Beispiel: 11 x Schubladenblendenhöhe 50 mm = Nutzhöhe 550 mm  
The sum of all drawer face heights must be equal to the useable front height of the cabinet housing.  
Example: 11 x Drawer face height 50 mm = Effective height 550 mm

Grids (17 mm per unit) make it easier for you to arrange the matching storage boxes, slotted panel sets and trough sets for your drawer size.



# Schubladenschränke | Breite / Width 576 x Tiefe / Depth 610 mm

## Drawer cabinets | Bestellbeispiele / Order examples

Höhe / Height 425 mm (Nutzhöhe / Eff. height 350 mm)

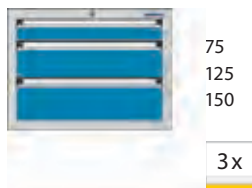

Auszug/Pull out	Best.-Nr./Ord. no.
Teilauszug / Part pull-out	00.05.2309
Vollauszug / Full pull-out	00.05.9208

Höhe / Height 625 mm (Nutzhöhe / Eff. height 550 mm)

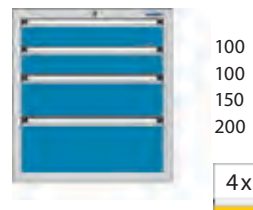

Auszug/Pull out	Best.-Nr./Ord. no.
Teilauszug / Part pull-out	00.05.2307
Vollauszug / Full pull-out	00.05.9210

Höhe / Height 800 mm (Nutzhöhe / Eff. height 725 mm)

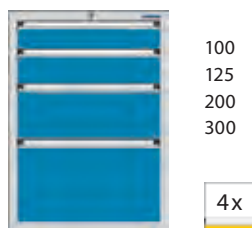

Auszug/Pull out	Best.-Nr./Ord. no.
Teilauszug / Part pull-out	00.05.9215
Vollauszug / Full pull-out	00.05.9216

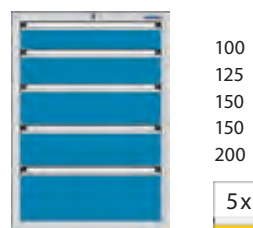

Auszug/Pull out	Best.-Nr./Ord. no.
Teilauszug / Part pull-out	00.05.9217
Vollauszug / Full pull-out	00.05.9218

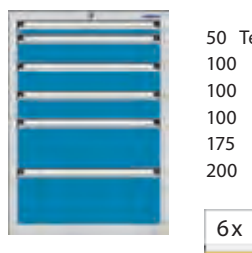

Auszug/Pull out	Best.-Nr./Ord. no.
Teilauszug / Part pull-out	00.05.9331
Vollauszug (außer Blendenhöhe 50 mm) Full pull-out (ex. face height 50 mm)	00.05.9332

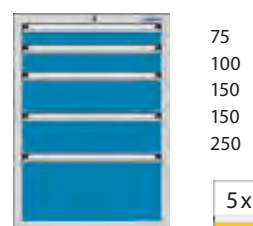

Auszug/Pull out	Best.-Nr./Ord. no.
Teilauszug / Part pull-out	00.05.9333
Vollauszug / Full pull-out	00.05.9334

**Schubladenschränke** | Breite / Width **576 x Tiefe / Depth 610 mm**

Drawer cabinets

Bestellbeispiele / Order examples

**Höhe / Height 1000 mm (Nutzhöhe / Eff. height 925 mm)**75  
75  
75  
150  
150  
200  
200

7x

75  
100  
200  
  
550  
(Tür)  
(Door)

3x

- Einschließlich ein Verstell- und Ausgleichsboden verzinkt
- Including a adjustable shelf and a bottom shelf, galvanized

Auszug/Pull out	Best.-Nr./Ord. no.
Teilauszug / Part pull-out	00.02.8184
Vollauszug / Full pull-out	00.05.9338

Auszug/Pull out	Best.-Nr./Ord. no.
Teilauszug / Part pull-out	00.02.8194
Vollauszug / Full pull-out	00.05.9340

**Fahrbar / Mobile: Gehäusehöhe / Height 625 mm, Nutzhöhe / Eff. height 550 mm, Gesamthöhe mit Rollen / Overall height with castors 782 mm**

(Rollen / Castors Ø 100 mm) Gesamtgew. / Total weight max. 450 kg

100  
100  
150  
200

4x

- Abrollrand mit Feinriefenmatte
- Jede Schublade mit Einzelverriegelung
- 2 Lenk- und 2 Bockrollen
- Roller tray with fine grooved mat
- Drawers with individual drawer interlock
- 2 swivel castors and 2 fixed castors

50 Teil-  
auszug  
100  
150  
250

4x

- Abrollrand mit Feinriefenmatte
- Jede Schublade mit Einzelverriegelung
- 2 Lenk- und 2 Bockrollen
- Roller tray with fine grooved mat
- Drawers with individual drawer interlock
- 2 swivel castors and 2 fixed castors

Auszug / Pull-out	Best.-Nr. / ord.-no.
Teilauszug / Part pull out	00.05.8924
Vollauszug / Full pull-out	00.05.9213

Auszug / Pull-out	Best.-Nr./Ord. no.
Teilauszug / Part pull-out	00.05.8925
Vollauszug (außer Blendenhöhe 50 mm) Full pull-out (ex. face height 50 mm)	00.05.9212

**Fahrbar / Mobile: Gehäusehöhe / Height 800 mm, Nutzhöhe / Eff. height 725 mm, Gesamthöhe mit Rollen / Overall height with castors 986 mm**

(Rollen / Rolls Ø 125 mm) Gesamtgew. / Total weight max. 750 kg

50 Teil-  
auszug  
75  
75  
75  
100  
150  
200

7x

- Abrollrand mit Feinriefenmatte
- Jede Schublade mit Einzelverriegelung
- 2 Lenk- und 2 Bockrollen
- Roller tray with fine grooved mat
- Drawers with individual drawer interlock
- 2 swivel castors and 2 fixed castors

75  
100  
100  
150  
300

5x

- Abrollrand mit Feinriefenmatte
- Jede Schublade mit Einzelverriegelung
- 2 Lenk- und 2 Bockrollen
- Roller tray with fine grooved mat
- Drawers with individual drawer interlock
- 2 swivel castors and 2 fixed castors

Auszug / Pull-out	Best.-Nr. / Ord.-no.
Teilauszug / Part Pull-out	00.05.8928
Vollauszug (außer Blendenhöhe 50 mm) Full pull-out (ex. face height 50 mm)	00.05.9335

Auszug / Pull-out	Best.-Nr./Ord. no.
Teilauszug / Part pull-out	00.05.8929
Vollauszug / Full pull-out	00.05.9336

# Schubladenschränke | Breite / Width 576 x Tiefe / Depth 610 mm

## Drawer cabinets | Zubehör / Accessories

### Abrollrand / 3-sided roller tray



- 3-seitig aufgekantetes Stahlblech, gefalzt
- Vernietet
- 3-sided roller tray, folded steel sheet
- Riveted

Breite / Width x Tiefe / Depth x Höhe / Height (mm)	Best.-Nr. / Ord.-no.
576 x 610 x 30	00.02.8141

### Abdeckplatten / Cover plates



- Lichtgraue Melaminharzbeschichtung
- Allseitig mit stoßfestem Kunststoffumleimer
- Verschraubbar
- Light-grey melamin resin coating
- All side with shockproof synthetic edging
- Can be screwed in

Breite / Width x Tiefe / Depth x Höhe / Height (mm)	Best.-Nr. / Ord.-no.
576 x 610 x 19	34.02.8123

### Feinriefenmatte / Fine grooved mat

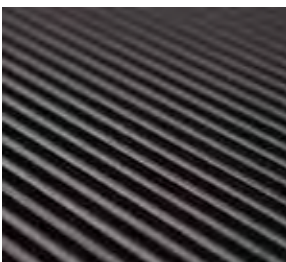

- Qualität SBR
- Schwarz
- Auch als separate Auflage nutzbar
- Quality SBR
- Black
- Can be used separately

Breite / Width x Tiefe / Depth x Höhe / Height (mm)	Best.-Nr. / Ord.-no.
573 x 609 x 3	35.02.8931

### Gehäuse-Sockel / Housing base



- Gehäusesockel als Höhenausgleich, Höhe: 50 mm oder 100 mm, Tiefe 610 mm
- Housing base to balance height, height: 50 mm oder 100 mm, depth 610 mm

Sockel Base	Höhe (mm) Height (mm)	Breite (mm) Width (mm)	Best.-Nr. Ord.-no.
Gehäuse-Sockel Housing base	50	576	00.05.2310
Gehäuse-Sockel Housing base	100	576	00.05.2311



## Schubladenschränke | Breite / Width 576 x Tiefe / Depth 610 mm

Drawer cabinets | Schubladeneinteilungssätze / Drawer partition sets

### Schlitzwandsätze / Slotted panel sets

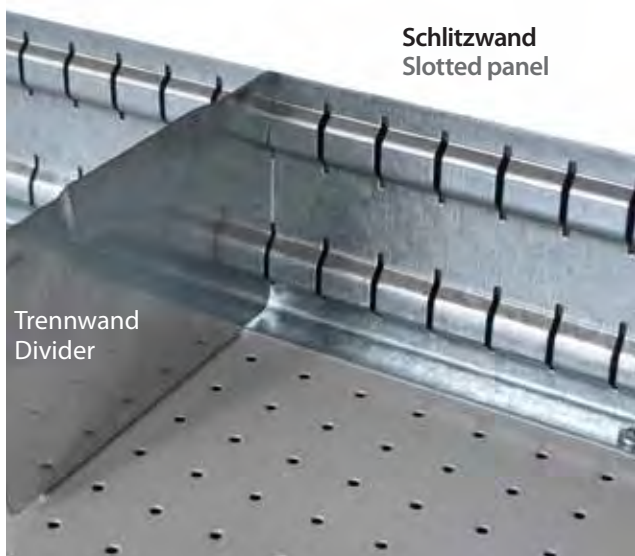

Blendenhöhen / Face heights	Best.-Nr. / Ord.-no.
50 mm	00.05.8951
75 mm	00.05.8952
100, 125 mm	00.05.8953
150, 175 mm	00.05.8954
200 mm	00.05.8955



Blendenhöhen / Face heights	Best.-Nr. / Ord.-no.
50 mm	00.05.8956
75 mm	00.05.8957
100, 125 mm	00.05.8958
150, 175 mm	00.05.8959
200 mm	00.05.8960



Blendenhöhen / Face heights	Best.-Nr. / Ord.-no.
50 mm	00.05.8961
75 mm	00.05.8962
100, 125 mm	00.05.8963
150, 175 mm	00.05.8964



Blendenhöhen / Face heights	Best.-Nr. / Ord.-no.
50 mm	00.05.8966
75 mm	00.05.8967
100, 125 mm	00.05.8968

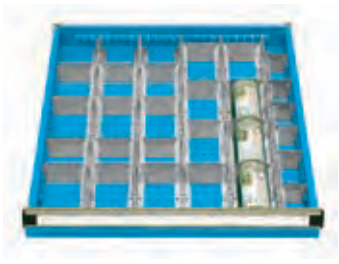

Blendenhöhen / Face heights	Best.-Nr. / Ord.-no.
50 mm	00.05.8971
75 mm	00.05.8972

# Schubladenschränke | Breite / Width 576 x Tiefe / Depth 610 mm

## Drawer cabinets | Schubladeneinteilungssätze / Drawer partition sets

### Schlitzwandsätze / Slotted panel sets



- 2 Schlitzwände 525 mm
- 2 Trennwände 201 mm
- 5 Trennwände 133 mm
- 2 Slotted panels 525 mm
- 2 Dividers 201 mm
- 5 Dividers 133 mm

Blendenhöhen / Face heights	Best.-Nr. / Ord.-no.
50 mm	00.05.8976
75 mm	00.05.8977
100, 125 mm	00.05.8978
150, 175 mm	00.05.9000
200 mm	00.05.9005



- 2 Schlitzwände 525 mm
- 2 Slotted panels 525 mm

Blendenhöhen / Face heights	Best.-Nr. / Ord.-no.
50 mm	00.05.9016
75 mm	00.05.9017
100, 125 mm	00.05.9018
150, 175 mm	00.05.9019
200, 250, 300, 400 mm	00.05.9020

### Lagerkastensätze / Insert boxes sets

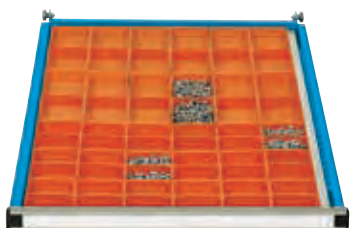

- 18 Einsatzkästen (75 x 75 x 26 mm)
- 12 Einsatzkästen (150 x 75 x 26 mm)
- 30 Trennwände steckbar
- 1 Ausgleichsleiste
- 18 insert boxes (75 x 75 x 26 mm)
- 12 insert boxes (150 x 75 x 26 mm)
- 30 Dividers insertable
- 1 Compensating strip

Blendenhöhe / Face height	Best.-Nr. / Ord.-no.
50 mm	00.05.8993

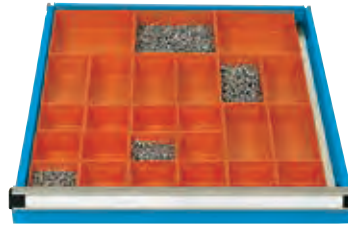

- 14 Einsatzkästen (75 x 75 x 26/46 mm)
- 8 Einsatzkästen (150 x 75 x 26/46 mm)
- 3 Einsatzkästen (150 x 150 x 26/46 mm)
- 1 Ausgleichsleiste
- 14 insert boxes (75 x 75 x 26/46 mm)
- 8 insert boxes (150 x 75 x 26/46 mm)
- 3 insert boxes (150 x 150 x 26/46 mm)
- 1 Compensating strip

Blendenhöhen / Face heights	Best.-Nr. / Ord.-no.
50 mm	00.05.8994
75 mm	00.05.8995

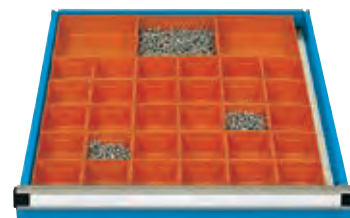

- 30 Einsatzkästen (75 x 75 x 26/46 mm)
- 3 Einsatzkästen (150 x 150 x 26/46 mm)
- 1 Ausgleichsleiste
- 30 insert boxes (75 x 75 x 26/46 mm)
- 3 insert boxes (150 x 150 x 26/46 mm)
- 1 Compensating strip

Blendenhöhen / Face heights	Best.-Nr. / Ord.-no.
50 mm	00.05.8996
75 mm	00.05.8997



- 9 Einsatzkästen (150 x 75 x 26/46/71 mm)
- 6 Einsatzkästen (150 x 150 x 26/46/71 mm)
- 1 Ausgleichsleiste
- 9 insert boxes (150 x 75 x 26/46/71 mm)
- 6 insert boxes (150 x 150 x 26/46/71 mm)
- 1 compensating strip

Blendenhöhen / Face heights	Best.-Nr. / Ord.-no.
50 mm	00.05.9001
75 mm	00.05.9002
100 mm	00.05.9003

## Schubladenschränke | Breite / Width 576 x Tiefe / Depth 610 mm

### Drawer cabinets | Schubladeneinteilungssätze / Drawer partition sets

#### Muldensätze aus Aluminium / Aluminium trough sets



- 7 Mulden 518 x 55 mm
- 1 Mulde 518 x 73 mm
- 28 Steckbleche 43 mm breit
- 3 Steckbleche 62 mm breit
- Muldenhöhe 35 mm
- 7 troughs 518 x 55 mm
- 1 trough 518 x 73 mm
- 28 metal inserts 43 mm wide
- 3 metal inserts 62 mm wide
- Trough height 35 mm

Blendenhöhe / Face height	Best.-Nr. / Ord.-no
75 mm	00.05.9009

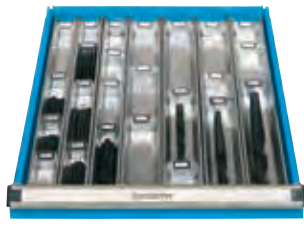

- 3 Mulden 518 x 55 mm
- 4 Mulden 518 x 73 mm
- 12 Steckbleche 43 mm breit
- 16 Steckbleche 62 mm breit
- Muldenhöhe 35 mm
- 3 troughs 518 x 55 mm
- 4 troughs 518 x 73 mm
- 12 metal inserts 43 mm wide
- 16 metal inserts 62 mm wide
- Trough height 35 mm

Blendenhöhe / Face height	Best.-Nr. / Ord.-no.
75 mm	00.05.9010

#### Zellkautschuk-Einlagen / Foam rubber inserts



- Zellkautschuk-Einlage für die Lagerung empfindlicher Messzeuge und Lehren
- Qualität EPDM, schwarz
- Breite 473 mm x Tiefe 525 x Dicke 3 mm
- Für alle Blendenhöhen

- Foam rubber insert for storing delicate measuring tools and gauges
- Quality EPDM, black
- Width 473 mm x Depth 525 x Thickness 3 mm, for all face heights

Best.-Nr. / Ord.-no.
27.05.9007



- Ablagefach mit Zellkautschuk-Einlage für Messzeuge (ohne Lagerkastensatz)
- Maße: Breite 473 x Tiefe 302 mm x Höhe 20 mm
- Verschiebbar

- Storage tray with rubber insert for measuring tools (without set of boxes)
- Width 473 x Depth 302 mm x Height 20 mm
- Adjustable

Blendenhöhen / Face heights	Best.-Nr. / Ord.-no.
75, 100, 125 mm	00.05.0928

#### AQRADO® - Modulares Ordnungssystem

##### Modular filing system



- AQRADO®-System bestehend aus: 4 Multiboxen, 8 Varioboxen, Inbusschlüsselbox, Messschieberbox, Klebepad, AQRADO®-Platte
- Breite 456 mm x Tiefe 504 mm x Höhe 52 mm

- AQRADO® system consisting of: 4 all-purpose boxes, 8 vario boxes, box for Allen keys, calliper box, sticky pad, AQRADO® board
- Width 456 mm x Depth 504 mm x Height 52 mm

Blendenhöhe / Face height	Best.-Nr. / Ord.-no.
Ab / From 75 mm	45.02.0065

#### Klemmleisten

##### Clamping strips

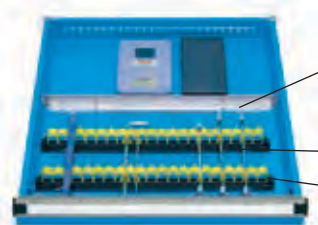

- Trennschiene für Blendenhöhe 50 mm: Effektive Höhe 32 mm, Länge 473 mm
- 2 Universal-Klemmleisten: 440 mm lang, mit 20 austauschbaren Kunststoffschlaufen, max. Klemmberreich Ø ca. 25 mm

- Divider for face height 50 mm: Effective height 32 mm, Length 473 mm
- 2 all-purpose clamping strips: 440 mm long, with 20 exchangeable plastic loops, max. clamping diameter Ø ca. 25 mm

Trennschiene für Blendenhöhe 50 mm Divider for face height 50 mm	Best.-Nr. / Ord.-no
Effektive Höhe 32 mm, Länge 473 mm Effective height 32 mm, Length 473 mm	00.05.9041
2 Stück Universal-Klemmleisten 2 all-purpose clamping strips	Best.-Nr. / Ord.-no.
	59.05.9013



# Schubladenschränke | Breite / Width 718 x Tiefe / Depth 728 mm

## Drawer cabinets | Produktmerkmale / Product characteristics

### Merkmale / Characteristics



### Schrankgehäusehöhen / Nutzhöhen für den Einbau von Schubladen

#### Cabinet housing heights / Effective heights for the assembly of drawers

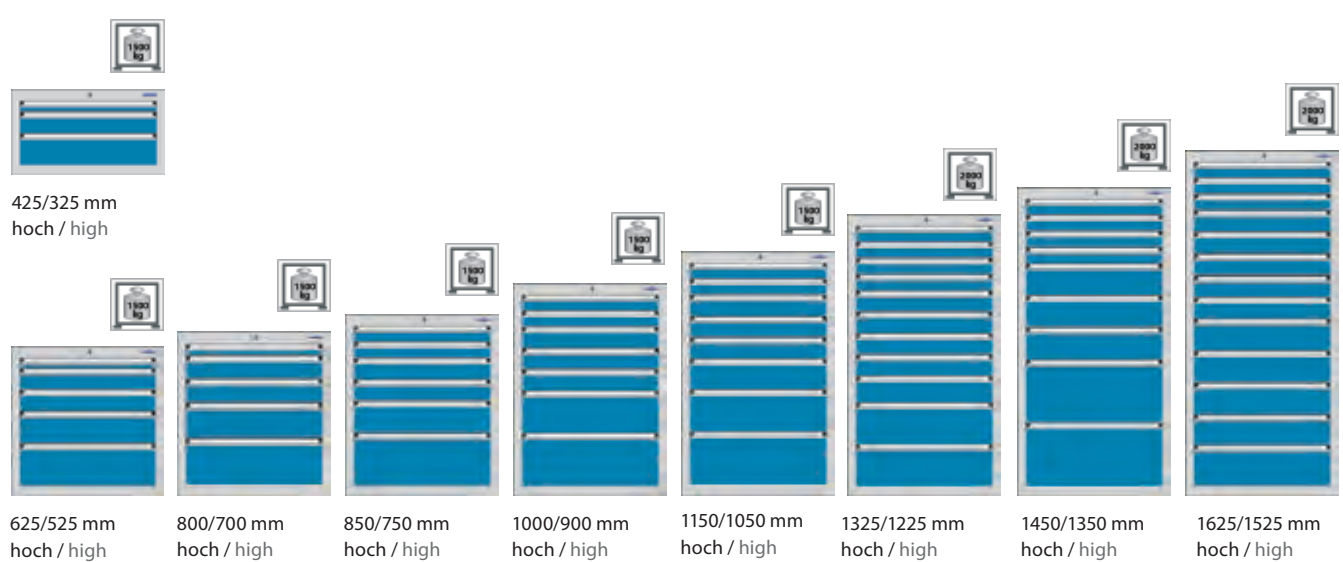

### Nutzmaße der Schubladen / Effective size of drawers

Blendenhöhe der Schubladen (mm) Drawer face height (mm)	Nutzhöhe der Schubladen (mm) Drawer effective height (mm)	Nutzfläche (Breite x Tiefe mm) Effective space (Width x Depth mm)
50	35	612 x 612
75	60	612 x 612
100	85	612 x 612
125	110	612 x 612
150	135	612 x 612
175	160	612 x 612
200	185	612 x 612
250	235	612 x 612
300	285	612 x 612

Nutzfläche im 17 mm Raster  
Effective space in 17 mm grid

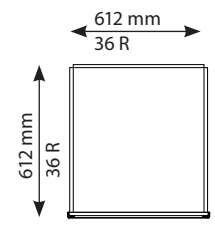

Raster (17 mm je Rastereinheit) erleichtern es Ihnen, die passenden Lagerkästen, Schlitzwandensätze oder Muldensätze für die Schubladengröße zusammen zu stellen.

Die Summe der Schubladenblendenhöhen muss der Nutzhöhe des Schrankgehäuses entsprechen.  
Beispiel: 9 x Blendenhöhe 50 mm + 1 x Blendenhöhe 75 mm = Nutzhöhe 525 mm  
The sum of all drawer face heights must be equal to the useable front height of the cabinet housing.  
Example: 9 x face height 50 mm + 1 x face height 75 mm = Effective height 525 mm

Grids (17 mm per unit) make it easier for you to arrange the matching storage boxes, slotted panel sets and trough sets for your drawer size.





# Schubladenschränke | Breite / Width 718 x Tiefe / Depth 728 mm

## Drawer cabinets | Bestellbeispiele / Order examples

Höhe / Height 425 mm (Nutzhöhe / Eff. height 325 mm)



Höhe / Height 625 mm (Nutzhöhe / Eff. height 525 mm)



75  
100  
150

3x



75  
100  
100  
100  
150

5x

Auszug/Pull out	Best.-Nr./Ord. no.
Teilauszug / Part pull-out	00.02.1521
Vollauszug / Full pull-out	00.02.1522

Auszug/Pull out	Best.-Nr./Ord. no.
Teilauszug / Part pull-out	00.02.1511
Vollauszug / Full pull-out	00.02.1512

Höhe / Height 800 mm (Nutzhöhe / Eff. height 700 mm)



Höhe / Height 1000 mm (Nutzhöhe / Eff. height 900 mm)



75  
75  
100  
100  
100  
250

6x



75  
75  
100  
100  
100  
200  
250

7x

Auszug/Pull out	Best.-Nr./Ord. no.
Teilauszug / Part pull-out	00.02.1525
Vollauszug / Full pull-out	00.02.1526

Auszug/Pull out	Best.-Nr./Ord. no.
Teilauszug / Part pull-out	00.02.1531
Vollauszug / Full pull-out	00.02.1532

Höhe / Height 1000 mm (Nutzhöhe / Eff. height 900 mm)



100  
100  
100  
150  
150  
300

6x



75  
75  
75  
100  
125  
125  
125  
200

8x

Auszug/Pull out	Best.-Nr./Ord. no.
Teilauszug / Part pull-out	00.02.1539
Vollauszug / Full pull-out	00.02.1540

Auszug/Pull out	Best.-Nr./Ord. no.
Teilauszug / Part pull-out	00.02.1543
Vollauszug / Full pull-out	00.02.1544



+32 (0)9 232 06 78



INFO@AWP.BE



DESTELBERGEN



**Schubladenschränke** | Breite / Width 718 x Tiefe / Depth 728 mm

Drawer cabinets

Bestellbeispiele / Order examples

Höhe / Height 1000 mm (Nutzhöhe / Eff. height 900 mm)

75  
75  
75  
75  
100  
100  
100  
150  
150

9x



9x100

9x

Auszug/Pull out	Best.-Nr./Ord. no.
Teilauszug / Part pull-out	00.02.1553
Vollauszug / Full pull-out	00.02.1554

Auszug/Pull out	Best.-Nr./Ord. no.
Teilauszug / Part pull-out	00.02.9343
Vollauszug / Full pull-out	00.02.9344



12 x 75

12x



6 x 150

6x

Auszug/Pull out	Best.-Nr./Ord. no.
Teilauszug / Part pull-out	00.02.9345
Vollauszug / Full pull-out	00.02.9346

Auszug/Pull out	Best.-Nr./Ord. no.
Teilauszug / Part pull-out	00.02.9347
Vollauszug / Full pull-out	00.02.9348

Höhe / Height 1000 mm (Nutzhöhe / Eff. height 900 mm)

50 Teilauszug / Part pull-out  
100 Teilauszug / Part pull-out  
150 Teilauszug / Part pull-out

3x

1 Auszugboden Vollauszug  
1 full pull-out panel shelf

- 3 Schubladen Teilauszug
- 1 Auszugboden Vollauszug
- Wahlweise mit Abrollrand und Feinriefenmatte
- Mit Flügeltüren und Schubladen-Ausziehsperr
- Gesamttiefe mit Vorsatztüre 754 mm

- 3 drawers part pull-out
- 1 full pull-out panel shelf
- Optional roller tray and fine groove mat
- With wing doors and drawer pull-out interlock
- Total depth with up-front door 754 mm

150 Teilauszug / Part pull-out  
150 Teilauszug / Part pull-out

2x

1 Auszugboden Vollauszug  
1 full pull-out panel shelf

- 2 Schubladen Teilauszug
- 1 Auszugboden Vollauszug
- Wahlweise mit Abrollrand und Feinriefenmatte
- Mit Flügeltüren und Schubladen-Ausziehsperr
- Gesamttiefe mit Vorsatztüre 754 mm

- 2 drawers part pull-out
- 1 full pull-out panel shelf
- Optional roller tray and fine groove mat
- With wing doors and drawer pull-out interlock
- Total depth with up-front door 754 mm

	Best.-Nr. / Ord.-no.
Inkl. Abrollrand und Feinriefenmatte Incl. roller tray and fine grooved mat	00.02.2029
Ohne Abrollrand und Feinriefenmatte Without roller tray and fine grooved mat	00.02.2031

	Best.-Nr./Ord.-no.
Inkl. Abrollrand und Feinriefenmatte Incl. roller tray and fine grooved mat	00.02.2028
Ohne Abrollrand und Feinriefenmatte Without roller tray and fine grooved mat	00.02.2030

# Schubladenschränke | Breite / Width 718 x Tiefe / Depth 728 mm

## Drawer cabinets | Bestellbeispiele / Order examples

Höhe / Height 1000 mm (Nutzhöhe / Eff. height 900 mm)



75 Teilauszug / Part pull-out  
75 Teilauszug / Part pull-out



75 Teilauszug / Part pull-out  
75 Teilauszug / Part pull-out  
2 Auszugböden Vollauszug  
2 full pull-out panel shelves

- 2 Schubladen Teilauszug
- 2 Einlegeböden
- Wahlweise mit Abrollrand und Feinriefenmatte
- Mit Flügeltüren und Schubladen-Ausziehsperr
- Gesamttiefe mit Vorsatztüre 754 mm

- 2 drawers part pull-out
- 2 panel shelves
- Optional roller tray and fine groove mat
- With wing doors and drawer pull-out interlock
- Total depth with up-front door 754 mm

- 2 Schubladen Teilauszug
- 2 Auszugböden Vollauszug
- Wahlweise mit Abrollrand und Feinriefenmatte
- Mit Flügeltüren und Schubladen-Ausziehsperr
- Gesamttiefe mit Vorsatztüre 754 mm

- 2 drawers part pull-out
- 2 full pull-out panel shelves
- Optional roller tray and fine groove mat
- With wing doors and drawer pull-out interlock
- Total depth with up-front door 754 mm

	Best.-Nr. / Ord.-no.
Inkl. Abrollrand und Feinriefenmatte Incl. roller tray and fine grooved mat	00.02.2037
Ohne Abrollrand und Feinriefenmatte Without roller tray and fine grooved mat	00.02.2035

	Best.-Nr. / Ord.-no.
Inkl. Abrollrand und Feinriefenmatte Incl. roller tray and fine grooved mat	00.02.2032
Ohne Abrollrand und Feinriefenmatte Without roller tray and fine grooved mat	00.02.2034

Höhe / Height 1325 mm (Nutzhöhe / Eff. height 1225 mm)



75  
75  
100  
100  
100  
100  
125  
150  
200  
300

Auszug/Pull out	Best.-Nr./Ord. no.
Teilauszug Part pull-out	00.02.1567
Vollauszug Full pull-out	00.02.1568



Höhe / Height 1450 mm (Nutzhöhe / Eff. height 1350 mm)



75  
75  
100  
100  
100  
100  
150  
150  
150  
150  
300

Auszug/Pull out	Best.-Nr./Ord. no.
Teilauszug Part pull-out	00.02.1577
Vollauszug Full pull-out	00.02.1578



Höhe / Height 1625 mm (Nutzhöhe / Eff. height 1525 mm)



75  
75  
75  
100  
100  
100  
100  
100  
100  
150  
150  
150  
150  
200



Höhe / Height 1450 mm (Nutzhöhe / Eff. height 1350 mm)



5 x 75

- 5 Schubladen
- 2 Auszugböden Vollauszug
- Mit Flügeltüren und Schubladen-Ausziehsperr
- Gesamttiefe mit Vorsatztüre 754 mm
- 5 drawers
- 2 full pull-out panel shelves
- With wing doors and drawer pull-out interlock
- Total depth with up-front door 754 mm



Auszug/Pull out	Best.-Nr./Ord. no.
Teilauszug / Part pull-out	00.02.1581
Vollauszug / Full pull-out	00.02.1582

Auszug/Pull out	Best.-Nr./Ord. no.
Teilauszug / Part pull-out	00.02.2036
Vollauszug / Full pull-out	00.02.2080

**Schubladerschränke** | Breite / Width 718 x Tiefe / Depth 728 mm

Drawer cabinets

Zubehör / Accessories

**Abrollrand / 3-sided roller tray**

- 3-seitig aufgekantetes Stahlblech, gefalzt
- Vernietet
- 3-sided roller tray, folded steel sheet
- Riveted

Breite / Width x Tiefe / Depth x Höhe / Height (mm)	Best.-Nr. / Ord.-no.
718 x 728 x 30	00.02.1617

**Abdeckplatten / Cover plates**

- Lichtgraue Melaminharzbeschichtung
- Allseitig mit stoßfestem Kunststoffumleimer
- Verschraubbar
- Light-grey melamin resin coating
- All side with shockproof synthetic edging
- Can be screwed in

Breite / Width x Tiefe / Depth x Höhe / Height (mm)	Best.-Nr. / Ord.-no.
718 x 728 x 19	34.02.1634

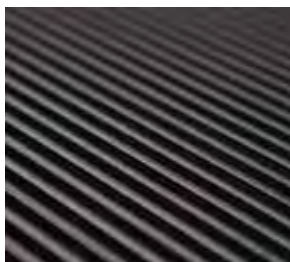
**Feinriefenmatte / Fine grooved mat**

- Qualität SBR
- Schwarz
- Auch als separate Auflage nutzbar
- Quality SBR
- Black
- Can be used separately

Breite / Width x Tiefe / Depth x Höhe / Height (mm)	Best.-Nr. / Ord.-no.
715 x 727 x 3	35.02.1609

**Gehäuse-Sockel / Housing base**

- Gehäusesockel als Höhenausgleich, Höhe: 50 mm oder 100 mm, Tiefe 728 mm
- Housing base to balance height, height: 50 mm oder 100 mm, depth 728 mm

Sockel Base	Höhe (mm) Height (mm)	Breite (mm) Width (mm)	Best.-Nr. Ord.-no.
Gehäuse-Sockel Housing base	50	718	00.02.1629
Gehäuse-Sockel Housing base	100	718	00.02.1630

**2-Weg Hubwagensockel / 2-way lift base**

- 2-Weg Hubwagensockel, Tiefe 728 mm, mit 2 abnehmbaren Blenden
- 2-way lift base, depth 728 mm, with 2 detachable panels

Sockel Base	Höhe (mm) Height (mm)	Breite (mm) Width (mm)	Best.-Nr. Ord.-no.
2-Weg-Hubwagensockel 2-way lift base	100	718	00.02.1609

# Schubladenschränke

Drawer cabinets

**Breite / Width 718 x Tiefe / Depth 728 mm**

Schubladeneinteilungssätze / Drawer partition sets

## Schlitzwandsätze / Slotted panel sets

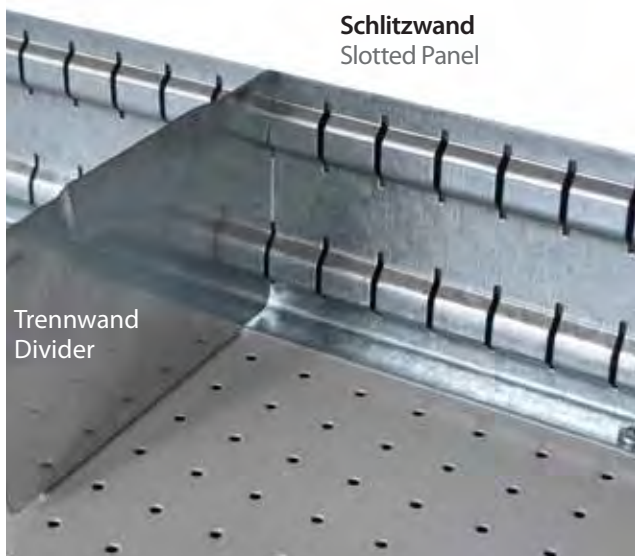

**Schlitzwand**  
Slotted Panel

**Trennwand**  
Divider



- 1 Schlitzwand 610 mm
- 2 Trennwände 303 mm, 18 R
- 1 Slotted panel 610 mm
- 2 Dividers 303 mm, 18 R

Blendenhöhen / Face heights	Best.-Nr. / Ord.-no.
50 mm	00.02.1766
75 mm	00.02.1767
100, 125 mm	00.02.1768
150, 175 mm	00.02.1769
200, 250,300,400 mm	00.02.1770



- 2 Schlitzwände 610 mm
- 8 Trennwände 201 mm, 12 R
- 2 Slotted panels 610 mm
- 8 Dividers 201 mm, 12 R

Blendenhöhen / Face heights	Best.-Nr. / Ord.-no.
50 mm	00.02.1771
75 mm	00.02.1772
100, 125 mm	00.02.1773
150, 175 mm	00.02.1774
200, 250,300,400 mm	00.02.1775



- 3 Schlitzwände 610 mm
- 6 Trennwände 150 mm, 9 R
- 3 Slotted panels 610 mm
- 6 Dividers 150 mm, 9 R

Blendenhöhen / Face heights	Best.-Nr. / Ord.-no.
50 mm	00.02.1811
75 mm	00.02.1812
100, 125 mm	00.02.1813
150, 175 mm	00.02.1814

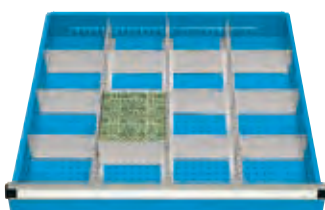

- 3 Schlitzwände 610 mm
- 12 Trennwände 150 mm, 9 R
- 3 Slotted panels 610 mm
- 12 Dividers 150 mm, 9 R

Blendenhöhen / Face heights	Best.-Nr. / Ord.-no.
50 mm	00.02.1781
75 mm	00.02.1782
100, 125 mm	00.02.1783
150, 175 mm	00.02.1784



- 4 Schlitzwände 610 mm
- 12 Trennwände 99 mm, 6 R
- 9 Trennwände 150 mm, 9 R
- 4 Slotted panels 610 mm
- 12 Dividers 99 mm, 6 R
- 9 Dividers 150 mm, 9 R

Blendenhöhen / Face heights	Best.-Nr. / Ord.-no.
50 mm	00.02.1786
75 mm	00.02.1787
100, 125 mm	00.02.1788
150, 175 mm	00.02.1789



## Schubladerschränke

Drawer cabinets

**Breite / Width 718 x Tiefe / Depth 728 mm**

Schubladeneinteilungsätze / Drawer partition sets

### Schlitzwandsätze / Slotted panel sets



- 5 Schlitzwände 610 mm
- 30 Trennwände 99 mm, 6 R
- 5 Slotted panels 610 mm
- 30 Dividers 99 mm, 6 R

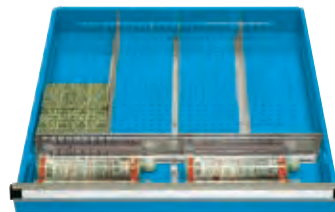

- 1 Schlitzwand 610 mm
- 1 Trennwand 150 mm, 9 R
- 3 Trennschienen 457 mm, 27 R
- 1 Slotted panel 610 mm
- 1 Divider 150 mm, 9 R
- 3 Dividing strips 457 mm, 27 R

Blendenhöhen / Face heights	Best.-Nr. / Ord.-no.
50 mm	00.02.1796
75 mm	00.02.1797
100, 125 mm	00.02.1798
150, 175 mm	00.02.1799

Blendenhöhen / Face heights	Best.-Nr. / Ord.-no.
50 mm	00.02.1816
75 mm	00.02.1817
100, 125 mm	00.02.1818
150, 175 mm	00.02.1819
200, 250,300,400 mm	00.02.1820



- 2 Trennschienen 610 mm, 36 R
- 2 Dividing strips 610 mm, 36 R

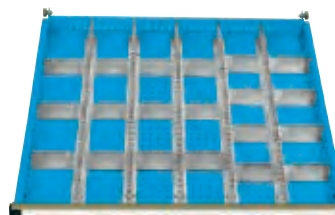

- 5 Schlitzwände 610 mm
- 20 Trennwände 99 mm, 6 R
- 5 Slotted panels 610 mm
- 20 Dividers 99 mm, 6 R

Blendenhöhen / Face heights	Best.-Nr. / Ord.-no.
50 mm	00.02.1801
75 mm	00.02.1802
100, 125 mm	00.02.1803
150, 175 mm	00.02.1804
200, 250,300,400 mm	00.02.1805

Blendenhöhen / Face heights	Best.-Nr. / Ord.-no.
50 mm	00.02.1791
75 mm	00.02.1792
100, 125 mm	00.02.1793



- 3 Schlitzwände 610 mm
- 4 Trennwände 150 mm, 9 R
- 3 Slotted panels 610 mm
- 4 Dividers 150 mm, 9 R



- 2 Schlitzwände 610 mm
- 3 Trennwände 201 mm, 12 R
- 2 Slotted panels 610 mm
- 3 Dividers 201 mm, 12 R

Blendenhöhen / Face heights	Best.-Nr. / Ord.-no.
50 mm	00.02.1876
75 mm	00.02.1877
100, 125 mm	00.02.1867
150, 175 mm	00.02.1878
200, 250,300,400 mm	00.02.1879

Blendenhöhen / Face heights	Best.-Nr. / Ord.-no.
50 mm	00.02.1887
75 mm	00.02.1889
100, 125 mm	00.02.1890
150, 175 mm	00.02.1800
200, 250,300,400 mm	00.02.1891

# Schubladenschränke

Drawer cabinets

**Breite / Width 718 x Tiefe / Depth 728 mm**

Schubladeneinteilungssätze / Drawer partition sets

## Muldensätze / Trough sets



- 16 Mulden 4-teilig
- 60 Steckwände 36 mm
- 16 troughs 4-part
- 60 trough inserts 36 mm

Blendenhöhen / Face heights	Best.-Nr. / Ord.-no.
50, 75 mm	00.02.1835



- 16 Mulden 3-teilig
- 50 Steckwände 48 mm
- 16 troughs 3-part
- 50 trough inserts 48 mm

Blendenhöhen / Face heights	Best.-Nr. / Ord.-no.
75, 100 mm	00.02.1836



- 16 Mulden 2-teilig
- 40 Steckwände 73 mm
- 16 troughs 2-part
- 40 trough inserts 73 mm

Blendenhöhen / Face heights	Best.-Nr. / Ord.-no.
100 mm	00.02.1837



- 4 Mulden 4-teilig
- 8 Mulden 3-teilig
- 4 Mulden 2-teilig
- 25 Steckwände 36 mm
- 30 Steckwände 48 mm
- 10 Steckwände 73 mm
- 4 troughs 4-part
- 8 troughs 3-part
- 4 troughs 2-part
- 25 trough inserts 36 mm
- 30 trough inserts 48 mm
- 10 trough inserts 73 mm

Blendenhöhen / Face heights	Best.-Nr. / Ord.-no.
75, 100 mm	00.02.1839

## Etiketten für Steckwände / Archiving labels & clear plastic strips

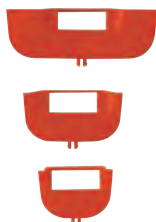

- Verpackungseinheit jeweils 25 Stück
- VE 25 ppp

	Best.-Nr. / Ord.-no.
Beschriftungs-Etiketten / Archiving labels	00.02.1841
Klarsichtfolie 27,5 x 12,5 mm Clear plastic strips	00.02.1846

## Zellkautschukeinlage / Foam rubber insert

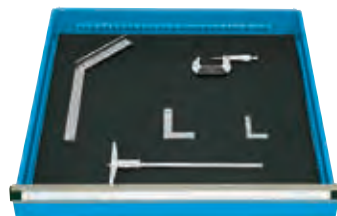

- Passend für alle Blendenhöhen
- Für die Lagerung empfindlicher Messzeuge und Lehren.
- Qualität EPDM
- Schwarz
- Breite 610 mm x Tiefe 610 mm x Stärke 3 mm
- Suitable for all face heights
- For storing delicate measuring tools and gauges
- Quality EPDM
- Black
- Width 610 mm x Depth 610 mm x Thickness 3 mm

Best.-Nr. / Ord.-no.
27.02.1785



## Schubladerschränke | Breite / Width 718 x Tiefe / Depth 728 mm

### Drawer cabinets | Schubladeneinteilungssätze / Drawer partition sets

#### Muldensatz aus Aluminium / Aluminium trough set

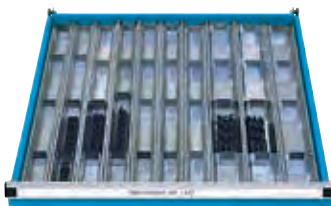

- 7 Mulden 602 x 55 mm
- 3 Mulden 602 x 73 mm
- 30 Steckbleche 43 mm
- 15 Steckbleche 62 mm
- Muldenhöhe 35 mm
- 7 troughs 602 x 55 mm
- 3 troughs 602 x 73 mm
- 30 metal inserts 43 mm
- 15 metal inserts 62 mm
- Trough height 35 mm

Blendenhöhe / Face height

75 mm

Best.-Nr. / Ord.-no.

00.02.1862



- 11 Mulden 602 x 55 mm
- 45 Steckbleche 43 mm
- Muldenhöhe 35 mm
- 11 troughs 602 x 55 mm
- 45 metal inserts 43 mm
- Trough height 35 mm

Blendenhöhe / Face height

75 mm

Best.-Nr. / Ord.-no.

00.02.1863

#### Rillensatz / 2-sided grooved inserts

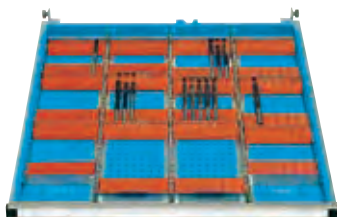

- 4 Paar 11 x Ø 8 mm
- 4 Paar 8 x Ø 14 mm
- 4 Paar 6 x Ø 20 mm
- 3 Schlitzwände 610 mm, 36 R
- 16 Trennwände 150 mm, 9 R
- 4 pairs 11 x Ø 8 mm
- 4 pairs 8 x Ø 14 mm
- 4 pairs 6 x Ø 20 mm
- 3 slotted panels 610 mm, 36 R
- 16 dividers 150 mm, 9 R

Blendenhöhen / Face heights

50, 75 mm

Best.-Nr. / Ord.-no.

00.02.1843

#### Einsatzkastensätze / Insert boxes sets



- 32 Einsatzkästen 75 x 75 x 26 mm
- 16 Einsatzkästen 150 x 75 x 26 mm
- 48 Trennwände, einsteckbar
- 32 insert boxes 75 x 75 x 26 mm
- 16 insert boxes 150 x 75 x 26 mm
- 48 dividers, insertable

Blendenhöhen / Face heights

50 mm

Best.-Nr. / Ord.-no.

00.02.1845

#### Einsatzkastensätze / Insert boxes sets

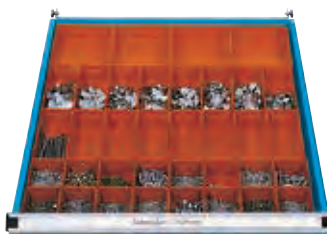

- 16 Einsatzkästen 75 x 75 x 26/46 mm
- 16 Einsatzkästen 150 x 75 x 26/46 mm
- 4 Einsatzkästen 150 x 150 x 26/46 mm
- 16 insert boxes 75 x 75 x 26/46 mm
- 16 insert boxes 150 x 75 x 26/46 mm
- 4 insert boxes 150 x 150 x 26/46 mm

Blendenhöhen / Face heights

50 mm

Best.-Nr. / Ord.-no.

00.02.1851

75 mm

00.02.1852



- 16 Einsatzkästen 150 x 75 x 26/46/71 mm
- 8 Einsatzkästen 150 x 150 x 26/46/71 mm
- 16 insert boxes 150 x 75 x 26/46/71 mm
- 8 insert boxes 150 x 150 x 26/46/71 mm

Blendenhöhen / Face heights

50 mm

Best.-Nr. / Ord.-no.

00.02.1858

75 mm

00.02.1859

100 mm

00.02.1860



# Schubladenschränke

Drawer cabinets

**Breite / Width 718 x Tiefe / Depth 728 mm**

Schubladeneinteilungssätze / Drawer partition sets

## Einsatzkastensätze / Insert boxes sets

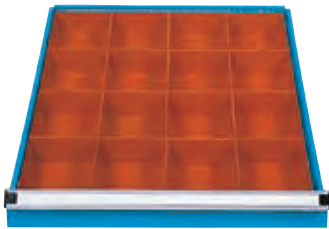

- 16 Einsatzkästen  
150 x 150 x 71 mm
- 16 insert boxes  
150 x 150 x 71 mm

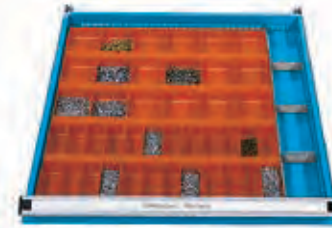

- 24 Lagerkästen  
43,5 x 115 x 37 mm Gr. 1
- 18 Lagerkästen  
87 x 115 x 37 mm Gr. 2
- 1 Schlitzwand 610 mm,  
1-seitig
- 3 Trennwände 82 mm, 5 R
- 24 storage boxes  
43,5 x 115 x 37 mm size 1
- 18 storage boxes  
87 x 115 x 37 mm size 2
- 1 slotted panel 610 mm,  
1-sided
- 3 dividers 82 mm, 5 R

Blendenhöhe / Face height	Best.-Nr. / Ord.-no.
100 mm	00.02.1875

Blendenhöhe / Face height	Best.-Nr. / Ord.-no.
75 mm	00.02.1893

## AQURADO® - Modulares Ordnungssystem / Modular filing system



- Schublade abmessen.
- Measure the drawer.



- Platte anritzen.
- Slit the board.



- Platte abbrechen.
- Break the board.



- Platte mit Klebepads einkleben.
- Glue the board with sticky pads into the drawer.



- Boxen einsetzen.
- Insert the boxes.



- AQURADO® System bestehend aus: 21 Universalboxen, Klebepad, AQURADO®-Platte
- Breite 600 mm x Tiefe 600 mm x Höhe 52 mm

- AQURADO® system consisting of: 21 all-purpose boxes, sticky pad, AQURADO® board
- Width 600 mm x Depth 600 mm x Height 52 mm

Blendenhöhen / Face heights	Best.-Nr. / Ord.-no.
Ab / From 75 mm	45.02.0062



- AQURADO®-System bestehend aus: Gabelringschlüsselbox, Schraubendreherbox, 10 Universalboxen, Klebepad, AQURADO®-Platte
- Breite 600 mm x Tiefe 600 mm x Höhe 52 mm

- AQURADO® system consisting of: combination wrench box, screw driver box, 10 all purpose boxes, sticky pad, AQURADO® board
- Width 600 mm x Depth 600 mm x Height 52 mm

Blendenhöhen / Face heights	Best.-Nr. / Ord.-no.
Ab / From 75 mm	45.02.0063

- Schnell und einfache Montage ohne Anzeichnen
- Passend für jede Schublade
- Das Baustein-Prinzip ermöglicht unendliche Einsatzmöglichkeiten.
- Der hochwertige Kunststoff garantiert lange Standzeiten. Beständig gegen Öl, Benzin, Fette, Säuren und Basen.
- Innen abgerundete Boxen erhöhen die Lebensdauer Ihrer Werkzeuge.
- Die Boxen sind, dank ihrer praktischen Form, übereinander stapelbar. Bitte beachten Sie dabei die Blendenhöhe.
- Beschriftungsschilder erhältlich

- Quick and simply fitting without marking
- Appropriate for each drawer
- The modular system allows endless applications
- High quality synthetics guarantees long service life. Resistant against oil, petrol, grease, acids and bases
- The boxes are rounded at the inside to rise the life time of your tools
- The boxes can be stacked on top of each other due to their convenient design. Please pay attention to the face height
- Archiving labels are available

# Schubladenschränke | Breite / Width 990 x Tiefe / Depth 806 mm

## Drawer cabinets | Produktmerkmale / Product characteristics

### Merkmale / Characteristics



### Schrankgehäusehöhen / Nutzhöhen für den Einbau von Schubladen

#### Cabinet housing heights / Effective heights for the assembly of drawers

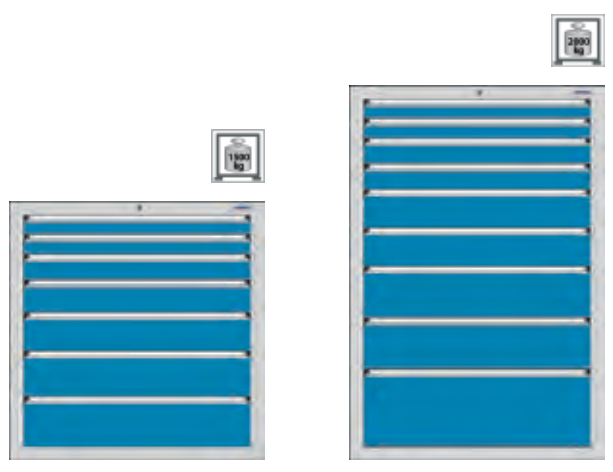

1000/900 mm hoch / high

1450/1350 mm hoch / high

### Nutzmaße der Schubladen / Effective size of drawers

Blendenhöhe der Schubladen (mm) Drawer face height (mm)	Nutzhöhe der Schubladen (mm) Drawer effective height (mm)	Nutzfläche (Breite x Tiefe mm) Effective space (Width x Depth mm)
50	35	884 x 697
75	60	884 x 697
100	85	884 x 697
125	110	884 x 697
150	135	884 x 697
175	160	884 x 697
200	185	884 x 697
250	235	884 x 697
300	285	884 x 697

### Nutzfläche im 17 mm Raster Effective space in 17 mm grid

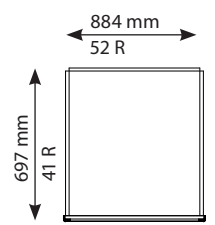

Raster (17 mm je Rastereinheit) erleichtern es Ihnen, die passenden Lagerkästen, Schlitzwand-sätze oder Muldensätze für die Schubladengröße zusammen zu stellen.

Grids (17 mm per unit) make it easier for you to arrange the matching storage boxes, slotted panel sets and trough sets for your drawer size.

Die Summe der Schubladenblendenhöhen muss der Nutzhöhe des Schrankgehäuses entsprechen.  
Beispiel: 9 x Blendenhöhe 100 mm = Nutzhöhe 900 mm  
The sum of all drawer face heights must be equal to the useable front height of the cabinet housing.  
Example: 9 x face height 100 mm = Effective height 900 mm

# Schubladenschränke | Breite / Width 990 x Tiefe / Depth 806 mm

## Drawer cabinets | Bestellbeispiele / Order examples

### Höhe / Height 1000 mm (Nutzhöhe / Eff. height 900 mm)



75  
75  
100  
125  
150  
175  
200



100  
100  
100  
150  
150  
300



Auszug / Pull-out	Best.-Nr. / Ord.-no.
Teilauszug / Part pull-out	00.02.9478
Vollauszug / Full pull-out	00.02.7915

Auszug / Pull-out	Best.-Nr. / Ord.-no.
Teilauszug / Part pull-out	00.02.7906
Vollauszug / Full pull-out	00.02.7907

### Höhe / Height 1000 mm (Nutzhöhe / Eff. height 900 mm)



75  
75  
75  
75  
100  
200  
300



100  
100  
100  
100  
150  
150  
200



Auszug / Pull-out	Best.-Nr. / Ord.-no.
Teilauszug / Part pull-out	00.02.7908
Vollauszug (außer 50 mm Blendenhöhe) Full pull-out (ex. 50 mm face height)	00.02.7909

Auszug / Pull-out	Best.-Nr. / Ord.-no.
Teilauszug / Part pull-out	00.02.7911
Vollauszug / Full pull-out	00.02.7912

### Höhe / Height 1000 mm (Nutzhöhe / Eff. height 900 mm)



100  
100  
100  
100  
100  
200  
200



75  
75  
100  
100  
100  
100  
150  
200



Auszug / Pull-out	Best.-Nr. / Ord.-no.
Teilauszug / Part pull-out	00.02.7949
Vollauszug / Full pull-out	00.02.7950

Auszug / Pull-out	Best.-Nr. / Ord.-no.
Teilauszug / Part pull-out	00.02.7916
Vollauszug / Full pull-out	00.02.7917

RS  
440RS  
565RS  
576RS  
717RS  
1000RS  
1024RS  
1196RS  
1434Schubl-  
regal

## Schubladerschränke | Breite / Width 990 x Tiefe / Depth 806 mm

Drawer cabinets

Bestellbeispiele / Order examples

Höhe / Height 1000 mm (Nutzhöhe / Eff. height 900 mm)

75  
75  
75  
75  
100  
100  
100  
100  
150  
150

9x

75  
75  
100  
150  
200  
300

6x

Auszug / Pull-out	Best.-Nr. / Ord.-no.
Teilauszug / Part pull-out	00.02.7918
Vollauszug / Full pull-out	00.02.7919

Auszug / Pull-out	Best.-Nr. / Ord.-no.
Teilauszug / Part pull-out	00.02.7923
Vollauszug / Full pull-out	00.02.7924

Höhe / Height 1450 mm (Nutzhöhe / Eff. height 1350 mm)

75  
75  
100  
100  
150  
150  
200  
200  
300

9x

75  
75  
100  
100  
100  
100  
150  
150  
200  
200  
200

10x

Auszug / Pull-out	Best.-Nr. / Ord.-no.
Teilauszug / Part pull-out	00.02.7931
Vollauszug / Full pull-out	00.02.7932

Auszug / Pull-out	Best.-Nr. / Ord.-no.
Teilauszug / Part pull-out	00.02.7933
Vollauszug / Full pull-out	00.02.7934

Höhe / Height 1450 mm (Nutzhöhe / Eff. height 1350 mm)

150  
150  
125  
75  
100  
100  
100  
100  
100  
150  
200  
200

10x

75  
75  
100  
100  
100  
100  
100  
100  
100  
150  
150  
200  
200

11x

Auszug / Pull-out	Best.-Nr. / Ord.-no.
Teilauszug / Part pull-out	00.02.7939
Vollauszug / Full pull-out	00.02.7940

Auszug / Pull-out	Best.-Nr. / Ord.-no.
Teilauszug / Part pull-out	00.02.7941
Vollauszug / Full pull-out	00.02.7942

# Schubladenschränke

Drawer cabinets

**Breite / Width 990 x Tiefe / Depth 806 mm**

Schubladeneinteilungsätze / Drawer partition sets

## Schlitzwandsätze / Slotted panel sets

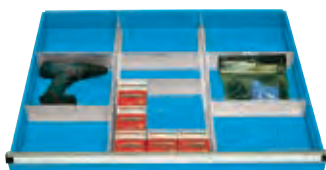

- 2 Schlitzwände 695 mm
- 2 Trennwände 269 mm, 16 R
- 4 Trennwände 303 mm, 18 R
- 2 slotted panels 695 mm
- 2 dividers 269 mm, 16 R
- 4 dividers 303 mm, 18 R

Blendenhöhen / Face heights	Best.-Nr. / Ord.-no.
50 mm	00.02.8001
75 mm	00.02.8002
100, 125 mm	00.02.8003
150, 175 mm	00.02.8004
200,250,300	00.02.8005



- 3 Schlitzwände 695 mm
- 6 Trennwände 201 mm, 12 R
- 6 Trennwände 235 mm, 14 R
- 3 slotted panels 695 mm
- 6 dividers 201 mm, 12 R
- 6 dividers 235 mm, 14 R

Blendenhöhen / Face heights	Best.-Nr. / Ord.-no.
50 mm	00.02.8006
75 mm	00.02.8007
100, 125 mm	00.02.8008
150, 175 mm	00.02.8009
200,250,300	00.02.8010

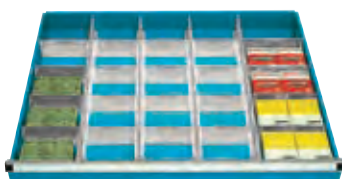

- 4 Schlitzwände 695 mm
- 16 Trennwände 167 mm, 10 R
- 4 Trennwände 201 mm, 12 R
- 4 slotted panels 695 mm
- 16 dividers 167 mm, 10 R
- 4 dividers 201 mm, 12 R

Blendenhöhen / Face heights	Best.-Nr. / Ord.-no.
50 mm	00.02.8011
75 mm	00.02.8012
100, 125 mm	00.02.8013
150, 175 mm	00.02.8014



- 5 Schlitzwände 695 mm
- 20 Trennwände 150 mm, 9 R
- 4 Trennwände 116 mm, 7 R
- 5 slotted panels 695 mm
- 20 dividers 150 mm, 9 R
- 4 dividers 116 mm, 7 R

Blendenhöhen / Face heights	Best.-Nr. / Ord.-no.
50 mm	00.02.8016
75 mm	00.02.8017
100, 125 mm	00.02.8018
150, 175 mm	00.02.8019



- 7 Schlitzwände 695 mm
- 30 Trennwände 116 mm, 7 R
- 10 Trennwände 82 mm, 5 R
- 7 slotted panels 695 mm
- 30 dividers 116 mm, 7 R
- 10 dividers 82 mm, 5 R

Blendenhöhen / Face heights	Best.-Nr. / Ord.-no.
50 mm	00.02.8021
75 mm	00.02.8022
100, 125 mm	00.02.8023



- 2 Schlitzwände 695 mm
- 4 Trennwände 133 mm, 8 R
- 3 Trennschienen 610 mm, 36 R
- 2 slotted panels 695 mm
- 4 dividers 133 mm, 8 R
- 3 dividing strips 610 mm, 36 R

Blendenhöhen / Face heights	Best.-Nr. / Ord.-no.
50 mm	00.02.8026
75 mm	00.02.8027
100, 125 mm	00.02.8028
150, 175 mm	00.02.8029



## Schubladenschränke

Drawer cabinets

Breite / Width 990 x Tiefe / Depth 806 mm

Schubladeneinteilungssätze / Drawer partition sets

### Muldensätze aus Aluminium / Aluminium trough sets

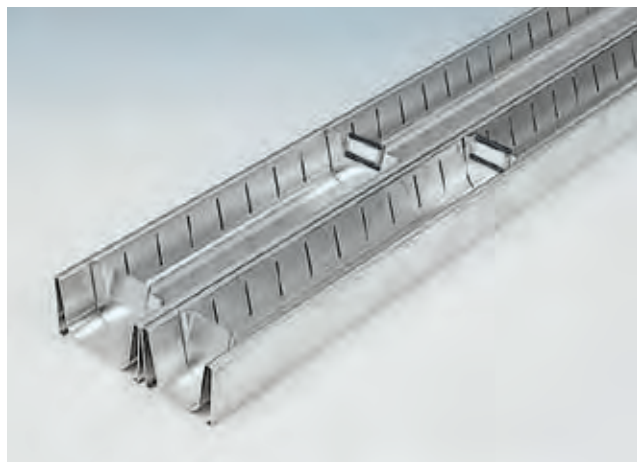

- 16 Mulden 693 x 55 mm
- 80 Steckbleche 43 mm
- Muldenhöhe 35 mm
- 16 troughs 693 x 55 mm
- 80 metal inserts 43 mm
- Trough height 35 mm

Blendenhöhe / Face height

75 mm

Best.-Nr. / Ord.-no.

00.02.8041

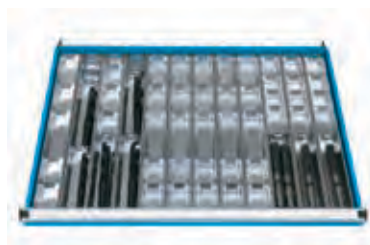

- 12 Mulden 693 x 73 mm
- 60 Steckbleche 62 mm
- Muldenhöhe 35 mm
- 12 troughs 693 x 73 mm
- 60 metal inserts 62 mm
- Trough height 35 mm

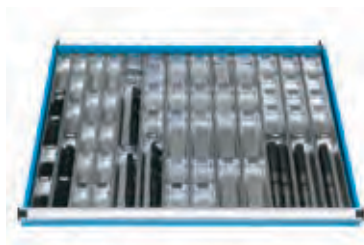

- 4 Mulden 693 x 55 mm
- 20 Steckbleche 43 mm
- 9 Mulden 693 x 73 mm
- 45 Steckbleche 62 mm
- Muldenhöhe 35 mm
- 4 troughs 693 x 55 mm
- 20 metal inserts 43 mm
- 9 troughs 693 x 73 mm
- 45 metal inserts 62 mm
- Trough height 35 mm

Blendenhöhe / Face height

75 mm

Best.-Nr. / Ord.-no.

00.02.8042

Blendenhöhe / Face height

75 mm

Best.-Nr. / Ord.-no.

00.02.8043

### Muldensätze aus PS-Kunststoff / HP plastic insert troughs

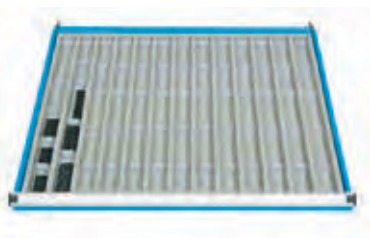

- 13 Mulden 50 mm breit
- 65 Steckwände 54 mm breit
- 13 troughs 50 mm wide
- 65 trough inserts 54 mm wide



- 10 Mulden 72 mm breit
- 50 Steckwände 76 mm breit
- 10 troughs 72 mm wide
- 50 trough inserts 76 mm wide

Blendenhöhe / Face height

75 mm

Satz / Set

13 Mulden, 65 Stw.  
13 troughs, 65 div.

Best.-Nr. / Ord.-no.

07.02.0267

zusätzl. Steckwand  
add. insert panel

07.02.0268

Blendenhöhen / Face heights

75, 100 mm

Satz / Set

10 Mulden, 50 Stw.  
10 troughs, 50 div.

Best.-Nr. / Ord.-no.

07.02.0269

zusätzl. Steckwand  
add. insert panel

07.02.0270

# Schubladenschränke

Drawer cabinets

**Breite / Width 990 x Tiefe / Depth 806 mm**

Schubladeneinteilungssätze / Drawer partition sets

## Muldensätze aus Aluminium / Aluminium troughs

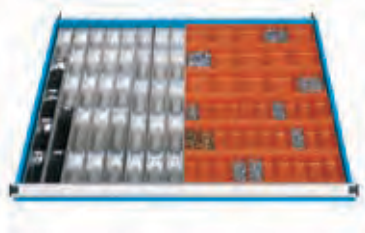

- 8 Mulden 693 x 55 mm
- 40 Steckbleche 43 mm
- 30 Lagerkästen Breite 43,5 mm x Tiefe 115 mm x Höhe 37 mm
- 15 Lagerkästen Breite 87 mm x Tiefe 115 mm x Höhe 37 mm

- 8 troughs 693 x 55 mm
- 40 metal inserts 43 mm
- 30 storage boxes Width 43,5 mm x Depth 115 mm x Height 37 mm
- 15 storage boxes Width 87 mm x Depth 115 mm x Height 37 mm

Blendenhöhe / Face height	Best.-Nr. / Ord.-no.
75 mm	00.02.8071

## Lagerkästensätze aus PS-Kunststoff / HP plastics storage boxes

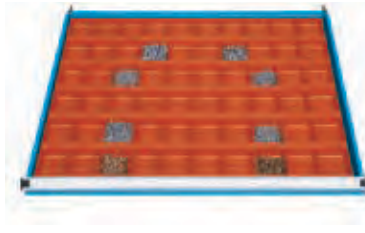

- 60 Lagerkästen Breite 87 mm x Tiefe 115 mm x Höhe 37 mm
- 60 storage boxes Width 87 mm x Depth 115 mm x Height 37 mm

Blendenhöhen / Face heights	Best.-Nr. / Ord.-no.
50, 75 mm	00.02.8062

## Lagerkästensätze aus PS-Kunststoff / HP plastics storage boxes

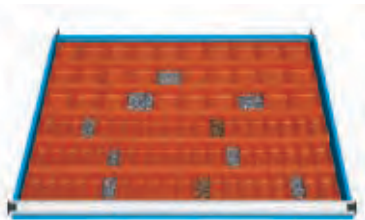

- 60 Lagerkästen Breite 43,5 mm x Tiefe 115 mm x Höhe 37 mm
- 30 Lagerkästen Breite 87 mm x Tiefe 115 mm x Höhe 37 mm
- 60 storage boxes Width 43,5 mm x Depth 115 mm x Height 37 mm
- 30 storage boxes Width 87 mm x Depth 115 mm x Height 37 mm

Blendenhöhen / Face heights	Best.-Nr. / Ord.-no.
50, 75 mm	00.02.8061

## Zellkautschuk-Einlage / Foam rubber insert



- Passend für alle Blendenhöhen
- Zur Lagerung empfindlicher Messzeuge und Lehren
- Qualität EPDM
- Schwarz, Breite 882 mm x Tiefe 695 mm x Dicke 3 mm

- Fits all face heights
- For storage of delicate measuring tools and gauges
- Quality EPDM
- Black, Width 882 mm x Depth 695 mm x Thickness 3 mm

Best.-Nr. / Ord.-no.
27.02.8066

## Lagerkästenhöhe 63 mm / Storage box height 63 mm



- 32 Lagerkästen Breite 54 mm x Tiefe 54 mm
- 32 Lagerkästen Breite 108 mm x Tiefe 54 mm
- 16 Lagerkästen Breite 108 mm x Tiefe 108 mm
- 8 Lagerkästen Breite 108 mm x Tiefe 162 mm
- 32 storage boxes Width 54 mm x Depth 54 mm
- 32 storage boxes Width 108 mm x Depth 54 mm
- 16 storage boxes Width 108 mm x Depth 108 mm
- 8 storage boxes Width 108 mm x Depth 162 mm

Blendenhöhe / Face height	Best.-Nr. / Ord.-no.
100 mm	01.02.0246

## Lagerkästenhöhe 45 mm / Storage box height 45 mm

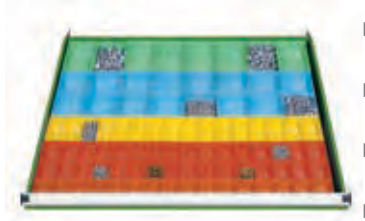

- 16 Lagerkästen Breite 54 mm x Tiefe 54 mm
- 32 Lagerkästen Breite 54 mm x Tiefe 75 mm
- 16 Lagerkästen Breite 54 mm x Tiefe 108 mm
- 16 Lagerkästen Breite 108 mm x Tiefe 108 mm
- 8 Lagerkästen Breite 108 mm x Tiefe 162 mm

- 16 storage boxes Width 54 mm x Depth 54 mm
- 32 storage boxes Width 54 mm x Depth 75 mm
- 16 storage boxes Width 54 mm x Depth 108 mm
- 16 storage boxes Width 108 mm x Depth 108 mm
- 8 storage boxes Width 108 mm x Depth 162 mm

Blendenhöhe / Face height	Best.-Nr. / Ord.-no.
75 mm	01.02.0245

# Schubladenschränke | Breite / Width 1024 x Tiefe / Depth 728 mm

## Drawer cabinets | Produktmerkmale / Product characteristics

### Merkmale / Characteristics



### Schrankgehäusehöhen / Nutzhöhen für den Einbau von Schubladen

#### Cabinet housing heights / Effective heights for the assembly of drawers

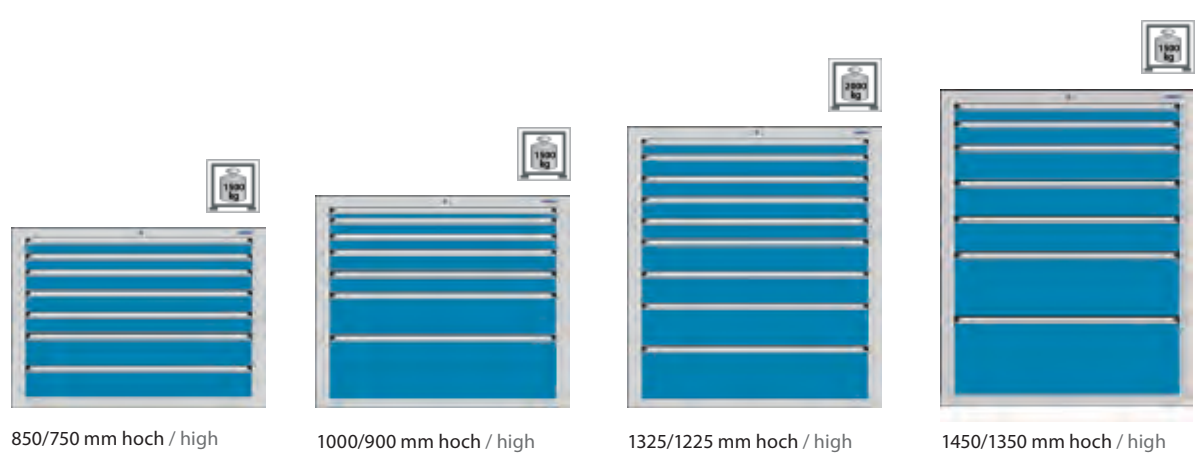

850/750 mm hoch / high      1000/900 mm hoch / high      1325/1225 mm hoch / high      1450/1350 mm hoch / high

### Nutzmaße der Schubladen / Effective size of drawers

Blendenhöhe der Schubladen (mm) Drawer face height (mm)	Nutzhöhe der Schubladen (mm) Drawer effective height (mm)	Nutzfläche (Breite x Tiefe mm) Effective space (Width x Depth mm)
50	35	918 x 612
75	60	918 x 612
100	85	918 x 612
125	110	918 x 612
150	135	918 x 612
175	160	918 x 612
200	185	918 x 612
250	235	918 x 612
300	285	918 x 612

Nutzfläche im 17 mm Raster  
Effective space in 17 mm grid

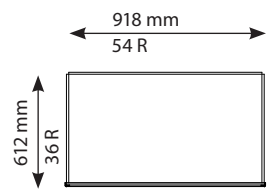

Raster (17 mm je Rastereinheit) erleichtern es Ihnen, die passenden Lagerkästen, Schlitzwand-sätze oder Muldensätze für die Schubladengröße zusammen zu stellen.

Die Summe der Schubladenblendenhöhen muss der Nutzhöhe des Schrankgehäuses entsprechen.  
Beispiel: 9 x Blendenhöhe 100 mm = Nutzhöhe 900 mm  
The sum of all drawer face heights must be equal to the useable front height of the cabinet housing.  
Example: 9 x face height 100 mm = Effective height 900 mm

Grids (17 mm per unit) make it easier for you to arrange the matching storage boxes, slotted panel sets and trough sets for your drawer size.



# Schubladenschränke | Breite / Width 1024 x Tiefe / Depth 728 mm

## Drawer cabinets | Bestellbeispiele / Order examples

### Höhe / Height 850 mm (Nutzhöhe / Eff. height 750 mm)



### Höhe / Height 1000 mm (Nutzhöhe / Eff. height 900 mm)

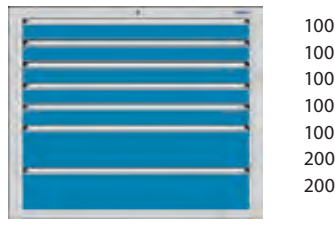

Auszug / Pull-out	Best.-Nr. / ord.-no.
Teilauszug / Part pull-out	00.02.7274
Vollauszug (außer Blendenhöhe 50 mm) Full pull-out (ex. face height 50 mm)	00.02.7275

Auszug / Pull-out	Best.-Nr. / ord.-no.
Teilauszug / Part pull-out	00.02.7280
Vollauszug / Full pull-out	00.02.7281

### Höhe / Height 1000 mm (Nutzhöhe / Eff. height 900 mm)

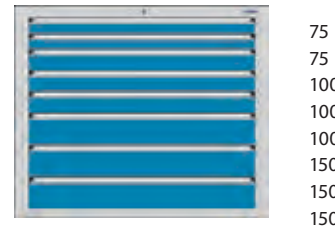

Auszug / Pull-out	Best.-Nr. / Ord.-no.
Teilauszug / Part pull-out	00.02.7278
Vollauszug / Full pull-out	00.02.7279

Auszug / Pull-out	Best.-Nr. / Ord.-no.
Teilauszug / Part pull-out	00.02.7282
Vollauszug / Full pull-out	00.02.7283

### Höhe / Height 1325 mm (Nutzhöhe / Eff. height 1225 mm)

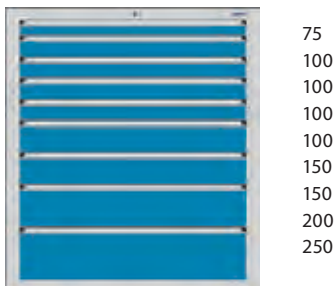

### Höhe / Height 1450 mm (Nutzhöhe / Eff. height 1350 mm)

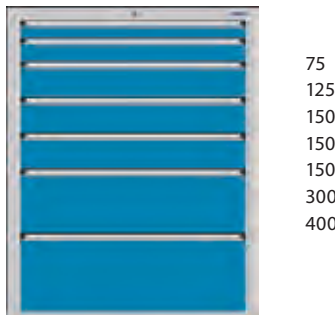

Auszug / Pull-out	Best.-Nr. / Ord.-no.
Teilauszug / Part pull-out	00.02.7284
Vollauszug / Full pull-out	00.02.7285

Auszug / Pull-out	Best.-Nr. / Ord.-no.
Teilauszug / Part pull-out	00.02.7286
Vollauszug / Full pull-out	00.02.7287

**Schubladerschränke** | Breite / Width 1024 x Tiefe / Depth 728 mm

Drawer cabinets

Zubehör / Accessories

**Abrollrand / 3-sided roller tray**

- 3-seitig aufgekantetes Stahlblech, gefälzt
- Vernietet
- 3-sided roller tray, folded steel sheet
- Riveted

Breite / Width x Tiefe / Depth x Höhe / Height (mm)	Best.-Nr. / Ord.-no.
1024 x 728 x 30	00.02.7320

**Abdeckplatten / Cover plates**

- Lichtgraue Melaminharzbeschichtung
- Allseitig mit stoßfestem Kunststoffumleimer
- Verschraubbar
- Light-grey melamin resin coating
- All side with shockproof synthetic edging
- Can be screwed in

Breite / Width x Tiefe / Depth x Höhe / Height (mm)	Best.-Nr. / Ord.-no.
1024 x 728 x 19	34.02.7322

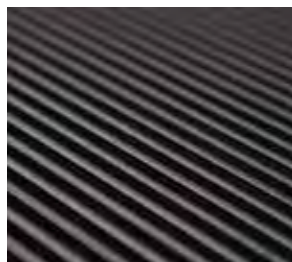
**Feinriefenmatte / Fine grooved mat**

- Qualität SBR
- Schwarz
- Auch als separate Auflage nutzbar
- Quality SBR
- Black
- Can be used separately

Breite / Width x Tiefe / Depth x Höhe / Height (mm)	Best.-Nr. / Ord.-no.
1020 x 727 x 3	35.02.7321

**Gehäuse-Sockel / Housing base**

- Gehäusesockel als Höhenausgleich, Höhe: 50 mm oder 100 mm, Tiefe 728 mm
- Housing base to balance height, height: 50 mm oder 100 mm, depth 728 mm

Sockel Base	Höhe (mm) Height (mm)	Breite (mm) Width (mm)	Best.-Nr. Ord.-no.
Gehäuse-Sockel Housing base	50	1024	00.02.7324
Gehäuse-Sockel Housing base	100	1024	00.02.7325

**2-Weg Hubwagensockel / 2-way lift base**

- 2-Weg Hubwagensockel, Tiefe 728 mm, mit 2 abnehmbaren Blenden
- 2-way lift base, depth 728 mm, with 2 detachable panels

Sockel Base	Höhe (mm) Height (mm)	Breite (mm) Width (mm)	Best.-Nr. Ord.-no.
2-Weg-Hubwagensockel 2-way lift base	100	1024	00.02.7326

# Schubladenschränke

Drawer cabinets

Breite / Width 1024 x Tiefe / Depth 728 mm

Schubladeneinteilungsätze / Drawer partition sets

## Schlitzwandsätze / Slotted panel sets



- 4 Schlitzwände 610 mm 36 R
- 2 Trennwände 150 mm 9 R
- 3 Trennwände 201 mm 12 R
- 4 slotted panels 610 mm 36 R
- 2 dividers 150 mm 9 R
- 3 dividers 201 mm 12 R

Blendenhöhen / Face heights	Best.-Nr. / Ord.-no.
50 mm	00.02.7330
75 mm	00.02.7331
100, 125 mm	00.02.7332
150, 175 mm	00.02.7333
200, 250, 300 mm	00.02.7354



- 5 Schlitzwände 610 mm 36 R
- 12 Trennwände 150 mm 9 R
- 5 slotted panels 610 mm 36 R
- 12 dividers 150 mm 9 R

Blendenhöhen / Face heights	Best.-Nr. / Ord.-no.
50 mm	00.02.7337
75 mm	00.02.7338
100, 125 mm	00.02.7339
150, 175 mm	00.02.7340
200, 250, 300 mm	00.02.7355



- 3 Schlitzwände 610 mm 36 R
- 3 Trennwände 201 mm 12 R
- 3 slotted panels 610 mm 36 R
- 3 dividers 201 mm 12 R

Blendenhöhen / Face heights	Best.-Nr. / Ord.-no.
50 mm	00.02.7334
75 mm	00.02.7335
100, 125 mm	00.02.7336
150, 175 mm	00.02.7356
200, 250, 300 mm	00.02.7357



- 6 Schlitzwände 610 mm 36 R
- 8 Trennwände 99 mm 6 R
- 4 Trennwände 150 mm 9 R
- 2 Trennwände 201 mm 12 R
- 6 slotted panels 610 mm 36 R
- 8 dividers 99 mm 6 R
- 4 dividers 150 mm 9 R
- 2 dividers 201 mm 12 R

Blendenhöhen / Face heights	Best.-Nr. / Ord.-no.
50 mm	00.02.7341
75 mm	00.02.7342
100, 125 mm	00.02.7343
150, 175 mm	00.02.7358

## Mulden aus Aluminium / Aluminium trough set



- 6 Mulden 602 x 55 mm
- 25 Steckbleche 43 mm
- 8 Mulden 602 x 73 mm
- 30 Steckbleche 62 mm
- Muldenhöhe 35 mm
- 6 troughs 602 x 55 mm
- 25 metal inserts 43 mm
- 8 troughs 602 x 73 mm
- 30 metal inserts 62 mm
- Trough height 35 mm

Blendenhöhe / Face height	Best.-Nr. / Ord.-no.
75 mm	00.02.7353

## Zellkautschuk-Einlage / Foam rubber insert

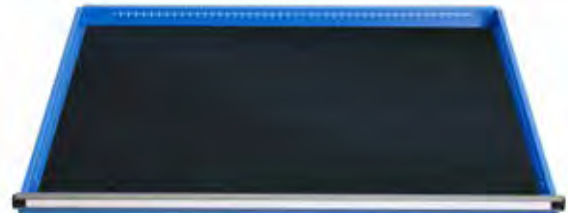

- Zellkautschuk-Einlage für die Lagerung empfindlicher Messzeuge und Lehren
- Qualität EPDM, schwarz
- Breite 916 mm x Tiefe 610 mm x Dicke 3 mm
- Passend für alle Blendenhöhen
- Rubber insert for storing delicate measuring tools and gauges
- Quality EPDM, black
- Width 916 mm x Depth 610 mm x Thickness 3 mm
- Fits all face heights

Best.-Nr. / Ord.-no.
27.02.7352



## Schubladenschränke | Breite / Width 1024 x Tiefe / Depth 728 mm

### Drawer cabinets | Schubladeneinteilungssätze / Drawer partition sets

#### Kunststoffmuldensätze / Plastic trough sets

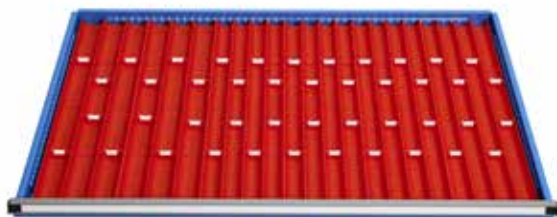

- 16 Mulden 4-teilig
- 32 Steckwände 4-teilig
- 8 Mulden 3-teilig
- 12 Steckwände 3-teilig
- 16 troughs 4-part
- 32 trough inserts 4-part
- 8 troughs 3-part
- 12 trough inserts 3-part



- 8 Mulden 4-teilig
- 16 Steckwände 4-teilig
- 8 Mulden 3-teilig
- 16 Steckwände 3-teilig
- 8 Mulden 2-teilig
- 12 Steckwände 2-teilig
- 8 troughs 4-part
- 16 trough inserts 4-part
- 8 troughs 3-part
- 16 trough inserts 3-part
- 8 troughs 2-part
- 12 trough inserts 2-part

Blendenhöhen / Face heights	Best.-Nr. / Ord.-no.
50, 75 mm	00.02.7344

Blendenhöhen / Face heights	Best.-Nr. / Ord.-no.
75, 100 mm	00.02.7345

#### Einsatzkastensätze / Insert boxes sets



- 24 Einsatzkästen Länge 150 mm x Breite 75 mm x Höhe 26/46/71 mm
- 12 Einsatzkästen Länge 150 mm x Breite 150 mm x Höhe 26/46/71 mm
- 24 insert boxes Length 150 mm x Width 75 mm x Height 26/46/71 mm
- 12 insert boxes Length 150 mm x Width 150 mm x Height 26/46/71 mm



- 48 Einsatzkästen Länge 75 mm x Breite 75 mm x Höhe 26/46 mm
- 24 Einsatzkästen Länge 150 mm x Breite 75 mm x Höhe 26/46 mm
- 48 insert boxes Length 75 mm x Width 75 mm x Height 26/46 mm
- 24 insert boxes Length 150 mm x Width 75 mm x Height 26/46 mm

Blendenhöhen / Face heights	Best.-Nr. / Ord.-no.
50 mm	01.08.0702
75 mm	01.08.0703
100 mm	01.08.0704

Blendenhöhen / Face heights	Best.-Nr. / Ord.-no.
50 mm	01.08.0705
75 mm	01.08.0706

#### AQRADO® - Modulares Ordnungssystem / Modular filing system



- AQRADO®-System, bestehend aus: 26 Universalboxen, Klebepad, AQRADO®-Platte
- Breite 912 mm x Tiefe 600 mm x Höhe 52 mm
- AQRADO® system, consisting of: 26 all-purpose boxes, sticky pad, AQRADO® board
- Width 912 mm x Depth 600 mm x Height 52 mm



- AQRADO®-System 15-teilig bestehend aus: 12 Universalboxen, Gabelringschlüsselbox, Schraubendreherbox, Klebepad, AQRADO®-Platte
- Breite 912 mm x Tiefe 600 mm x Höhe 52 mm
- AQRADO®-System 15-part, consisting of: 12 all-purpose boxes, combination wrench box, sticky pad, AQRADO® board
- Width 912 mm x Depth 600 mm x Height 52 mm

Blendenhöhe / Face height	Best.-Nr. / Ord.-no.
Ab / From 75 mm	45.02.0074

Blendenhöhe / Face height	Best.-Nr. / Ord.-no.
Ab / From 75 mm	45.02.0075



# Schubladenschränke | Breite / Width 1196 x Tiefe / Depth 728 mm

## Drawer cabinets | Produktmerkmale / Product characteristics

### Merkmale / Characteristics



### Schrankgehäusehöhen / Nutzhöhen für den Einbau von Schubladen

#### Cabinet housing heights / Effective heights for the assembly of drawers



850/750 mm hoch / high      1000/900 mm hoch / high      1325/1225 mm hoch / high      1450/1350 mm hoch / high

### Nutzmaße der Schubladen / Effective size of drawers

Blendenhöhe der Schubladen (mm) Drawer face height (mm)	Nutzhöhe der Schubladen (mm) Drawer effective height (mm)	Nutzfläche (Breite x Tiefe mm) Effective space (Width x Depth mm)
50	35	1088 x 612
75	60	1088 x 612
100	85	1088 x 612
125	110	1088 x 612
150	135	1088 x 612
175	160	1088 x 612
200	185	1088 x 612
250	235	1088 x 612
300	285	1088 x 612

#### Nutzfläche im 17 mm Raster Effective space in 17 mm grid

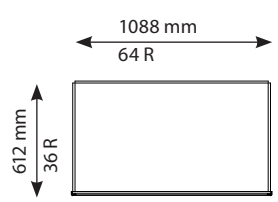

Raster (17 mm je Rastereinheit) erleichtern es Ihnen, die passenden Lagerkästen, Schlitzwand-sätze oder Muldensätze für die Schubladengröße zusammen zu stellen.

Grids (17 mm per unit) make it easier for you to arrange the matching storage boxes, slotted panel sets and trough sets for your drawer size.

Die Summe der Schubladenblendenhöhen muss der Nutzhöhe des Schrankgehäuses entsprechen.  
Beispiel: 9 x Blendenhöhe 100 mm = Nutzhöhe 900 mm  
The sum of all drawer face heights must be equal to the useable front height of the cabinet housing.  
Example: 9 x face height 100 mm = Effective height 900 mm

# Schubladenschränke | Breite / Width 1196 x Tiefe / Depth 728 mm

## Drawer cabinets | Bestellbeispiele / Order examples

Höhe / Height 850 mm (Nutzhöhe / Eff. height 750 mm)



75  
75  
100  
100  
100  
150  
150

7x



75  
100  
100  
125  
150  
200

6x

Auszug/Pull out	Best.-Nr./Ord. no.
Teilauszug / Part pull-out	00.02.7573
Vollauszug / Full pull-out	00.02.9283

Auszug/Pull out	Best.-Nr./Ord. no.
Teilauszug / Part pull-out	00.02.7574
Vollauszug / Full pull-out	00.02.7575

Höhe / Height 1000 mm (Nutzhöhe / Eff. height 900 mm)



75  
100  
125  
150  
200  
250

6x



75  
75  
100  
100  
100  
100  
150  
200

8x

Auszug/Pull out	Best.-Nr./Ord. no.
Teilauszug / Part pull-out	00.02.7576
Vollauszug / Full pull-out	00.02.7577

Auszug/Pull out	Best.-Nr./Ord. no.
Teilauszug / Part pull-out	00.02.7569
Vollauszug / Full pull-out	00.02.7570

Höhe / Height 1325 mm (Nutzhöhe / Eff. height 1225 mm)



Höhe / Height 1450 mm (Nutzhöhe / Eff. height 1350 mm)



75  
100  
100  
100  
100  
150  
150  
200  
250

9x



100  
125  
150  
175  
250  
250  
300

7x

Auszug/Pull out	Best.-Nr./Ord. no.
Teilauszug / Part pull-out	00.02.7598
Vollauszug / Full pull-out	00.02.7599

Auszug/Pull out	Best.-Nr./Ord. no.
Teilauszug / Part pull-out	00.02.7578
Vollauszug / Full pull-out	00.02.7579



## Schubladenschränke | Breite / Width 1196 x Tiefe / Depth 728 mm

Drawer cabinets

Zubehör / Accessories

### Abrollrand / 3-sided roller tray



- 3-seitig aufgekantetes Stahlblech, gefalzt
- Vernietet
- 3-sided roller tray, folded steel sheet
- Riveted

Breite / Width x Tiefe / Depth x Höhe / Height (mm)	Best.-Nr. / Ord.-no.
1196 x 728 x 30	00.02.7506

### Abdeckplatten / Cover plates



- Lichtgraue Melaminharzbeschichtung
- Allseitig mit stoßfestem Kunststoffumleimer
- Verschraubbar
- Light-grey melamin resin coating
- All side with shockproof synthetic edging
- Can be screwed in

Breite / Width x Tiefe / Depth x Höhe / Height (mm)	Best.-Nr. / Ord.-no.
1196 x 728 x 19	34.02.7511

### Feinriefenmatte / Fine grooved mat

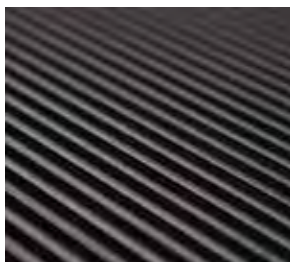

- Qualität SBR
- Schwarz
- Auch als separate Auflage nutzbar
- Quality SBR
- Black
- Can be used separately

Breite / Width x Tiefe / Depth x Höhe / Height (mm)	Best.-Nr. / Ord.-no.
1193 x 727 x 3	35.02.7507

### Gehäuse-Sockel / Housing base



- Gehäusesockel als Höhenausgleich, Höhe: 50 mm oder 100 mm, Tiefe 728 mm
- Housing base to balance height, height: 50 mm oder 100 mm, depth 728 mm

Sockel Base	Höhe (mm) Height (mm)	Breite (mm) Width (mm)	Best.-Nr. Ord.-no.
Gehäuse-Sockel Housing base	50	1196	00.02.7544
Gehäuse-Sockel Housing base	100	1196	00.02.7509

### 2-Weg Hubwagensockel / 2-way lift base



- 2-Weg Hubwagensockel, Tiefe 728 mm, mit 2 abnehmbaren Blenden
- 2-way lift base, depth 728 mm, with 2 detachable panels

Sockel Base	Höhe (mm) Height (mm)	Breite (mm) Width (mm)	Best.-Nr. Ord.-no.
2-Weg-Hubwagensockel 2-way lift base	100	1196	00.02.7510



# Schubladenschränke | Breite / Width 1196 x Tiefe / Depth 728 mm

## Drawer cabinets | Schubladeneinteilungssätze / Drawer partition sets

### Schlitzwandsätze / Slotted panel sets



- 7 Schlitzwände 610 mm 36 R
- 18 Trennwände 116 mm 7 R
- 2 Trennwände 167 mm 10 R
- 2 Trennwände 201 mm 12 R
- 7 slotted panels 610 mm 36 R
- 18 dividers 116 mm 7 R
- 2 dividers 167 mm 10 R
- 2 dividers 201 mm 12 R

Blendenhöhen / Face heights	Best.-Nr. / Ord.-no.
50 mm	00.02.7601
75 mm	00.02.7602
100, 125 mm	00.02.7603
150 mm	00.02.7604



- 10 Schlitzwände 610 mm 36 R
- 4 Trennwände 65 mm 4 R
- 40 Trennwände 99 mm 6 R
- 10 slotted panels 610 mm 36 R
- 4 dividers 65 mm 4 R
- 40 dividers 99 mm 6 R

Blendenhöhen / Face heights	Best.-Nr. / Ord.-no.
50 mm	00.02.7606
75 mm	00.02.7607
100, 125 mm	00.02.7608

### Schlitzwandsätze / Slotted panel sets



- 5 Schlitzwände 610 mm 36 R
- 12 Trennwände 133 mm 8 R
- 8 Trennwände 269 mm 16 R
- 5 slotted panels 610 mm 36 R
- 12 dividers 133 mm 8 R
- 8 dividers 269 mm 16 R

Blendenhöhen / Face heights	Best.-Nr. / Ord.-no.
50 mm	00.02.7615
75 mm	00.02.7616
100, 125 mm	00.02.7617
150, 175 mm	00.02.7618
200 mm	00.02.7619

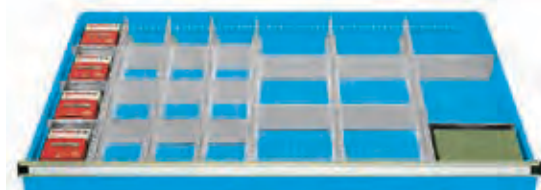

- 6 Schlitzwände 610 mm 36 R
- 12 Trennwände 116 mm 7 R
- 6 Trennwände 201 mm 12 R
- 6 slotted panels 610 mm 36 R
- 12 dividers 116 mm 7 R
- 6 dividers 201 mm 12 R

Blendenhöhen / Face heights	Best.-Nr. / Ord.-no.
50 mm	00.02.7611
75 mm	00.02.7612
100, 125 mm	00.02.7613
150, 175 mm	00.02.7614

### Schlitzwandsätze / Slotted panel sets



- 3 Schlitzwände 610 mm 36 R
- 8 Trennwände 269 mm 16 R
- 3 slotted panels 610 mm 36 R
- 8 dividers 269 mm 16 R

Blendenhöhen / Face heights	Best.-Nr. / Ord.-no.
50 mm	00.02.7580
75 mm	00.02.7581
100, 125 mm	00.02.7582
150, 175 mm	00.02.7583
200 mm	00.02.7584

### Zellkautschuk-Einlage / Foam rubber insert



- Zellkautschuk-Einlage für die Lagerung empfindlicher Messzeuge und Lehren
- Qualität EPDM, schwarz
- Breite 1086 mm x Tiefe 610 mm x Dicke 3 mm
- Passend für alle Blendenhöhen
- Foam rubber insert for storing delicate measuring tools and gauges
- Quality EPDM, black
- Width 1086 mm x Depth 610 mm x Thickness 3 mm
- Fits all face heights

Best.-Nr. / Ord.-no.
27.02.7620

**Schubladenschränke**

Drawer cabinets

**Breite / Width 1196 x Tiefe / Depth 728 mm**

Schubladeneinteilungssätze / Drawer partition sets

**Muldensätze aus Aluminium / Aluminium trough set**

- 9 Mulden 602 x 55 mm
- 45 Steckbleche 43 mm
- 8 Mulden 602 x 73 mm
- 40 Steckbleche 62 mm
- Muldenhöhe 35 mm
- 9 troughs 602 x 55 mm
- 45 metal inserts 43 mm
- 8 troughs 602 x 73 mm
- 40 metal inserts 62 mm
- Trough height 35 mm

Blendenhöhen / Face heights

75, 100 mm

Best.-Nr. / Ord.-no.

00.02.7623

**Muldensätze / Trough sets**

- 24 Mulden 3-teilig
- 75 Steckwände 48 mm
- 2 Schlitzwände 610 mm einseitig
- 3 Trennwände 167 mm 10 R
- 24 troughs 3-teilig
- 75 insert panels 48 mm
- 2 slotted panels 610 mm einseitig
- 3 dividers 167 mm 10 R

Blendenhöhen / Face heights

75, 100 mm

Best.-Nr. / Ord.-no.

00.02.7621

**Muldensätze / Insert boxes**

- 24 Einsatzkästen 75 x 75 x 26/46 mm
- 24 Einsatzkästen 150 x 75 x 26/46 mm
- 6 Einsatzkästen 150 x 150 x 26/46 mm
- 2 Schlitzwände 610 mm 36 R
- 3 Trennwände 167 mm 10 R
- 24 insert boxes 75 x 75 x 26/46 mm
- 24 insert boxes 150 x 75 x 26/46 mm
- 6 insert boxes 150 x 150 x 26/46 mm
- 2 slotted panels 610 mm 36 R
- 3 dividers 167 mm 10 R

Blendenhöhen  
Face heights

50 mm

75 mm

Höhe Schlitz- und Trennwände  
Height of panels and dividers

32 mm

50 mm

Best.-Nr.  
Ord.-no.

00.02.7631

00.02.7632



- 16 Einsatzkästen 150 x 75 x 26/46/71 mm
- 8 Einsatzkästen 150 x 150 x 26/46/71
- 4 Schlitzwände 610 mm 36 R
- 4 Trennwände 133 mm 8 R
- 6 Trennwände 99 mm 6 R
- 16 insert boxes 150 x 75 x 26/46/71 mm
- 8 insert boxes 150 x 150 x 26/46/71
- 4 slotted panels 610 mm 36 R
- 4 dividers 133 mm 8 R
- 6 dividers 99 mm 6 R

Blendenhöhen  
Face heights

50 mm

75 mm

100 mm

Höhe Schlitz- und Trennwände  
Height of panels and dividers

32 mm

50 mm

75 mm

Best.-Nr.  
Ord.-no.

00.02.7636

00.02.7637

00.02.7638

**AQRADO® - Modulares Ordnungssystem / Modular filing system**

- AQRADO®-System bestehend aus: 18 Universalboxen, Klebepad, AQRADO®-Platte
- Breite 1080 mm x Tiefe 600 mm x Höhe 52 mm
- AQRADO® system consisting of: 18 all-purpose boxes, sticky pad, AQRADO® board
- Width 1080 mm x Depth 600 mm x Height 52 mm

Blendenhöhen / Face heights

Ab / From 75 mm

Best.-Nr. / Ord.-no.

45.02.0068



- AQRADO®-System bestehend aus: 22 Universalboxen, Klebepad, AQRADO®-Platte
- Breite 1080 mm x Tiefe 600 mm x Höhe 52 mm
- AQRADO® system consisting of: 22 all-purpose boxes, sticky pad, AQRADO® board
- Width 1080 mm x Depth 600 mm x Height 52 mm

Blendenhöhen / Face heights

Ab / From 75 mm

Best.-Nr. / Ord.-no.

45.02.0069

# Schubladenschränke | Werkzeugausgabe

## Drawer cabinets | Tool store

### Merkmale / Characteristics



- Durch die Schrankgehäusebreiten 565, 718, 1024, 1196 und 1434 mm mit umfangreichen Ausführungsvarianten ergeben sich vielseitig Kombinationsmöglichkeiten bis hin zur kompletten Werkzeug- und Materialausgabe.
- Unsere praxiserfahrenen Fachberater übernehmen gerne die Planung Ihrer Material- und Werkzeugausgabe unter Berücksichtigung innerbetrieblicher Gegebenheiten und Belange. Bitte fordern Sie unser Angebot an.
- Our different housing widths of 565, 718, 1024, 1196 and 1434 mm with vast options for your individual configuration allow many combinations up to the entire tools and materials store.
- Our well-trained advisors have lots of field-experience and are looking forward to plan your materials and tools department with a close look at your company's requirements and concerns.

### Eckschrank für Schubladenschränke 728 mm tief / Corner cabinet for drawer cabinet housing 728 mm deep

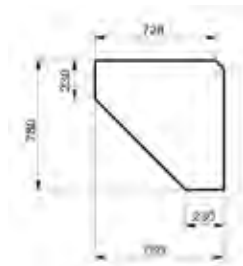

- Dieser Eckschrank wird bei der rechtwinkligen Anordnung von Werkzeugausgaben mit Schubladenschränken mit Gehäusebreiten 565, 718, 1024, 1196 und 1434 mm benötigt.
- Solide, stabile Stahlblechkonstruktion mit 2 Flügeltüren von außen zu öffnen, Flügeltüren gemeinsam verschließbar durch Drehgriff (2-Punkt-Verriegelung).
- Fachböden im Rast von 17,5 : 17,5 mm verstellbar.
- This corner cabinet is required when the tool store has been configured to form an L-shape by using drawer cabinets of 565, 718, 1024, 1196 and 1434 mm width.
- A sound and stable steel sheet construction with 2 wing doors (to be opened from the outside); both wing doors uni-locking via turning handle (2-point locking system)
- Shelf panel can be adjusted according to a 17.5 : 17.5 mm grid

Artikel / Product	Best.-Nr. / Ord.-no.
Eckschrank mit 2 Fachböden / Corner cabinet with 2 shelf panels	00.02.1600
Fachboden, einschl. 6 Bodenträger / Shelf panel incl. 6 supports	00.02.1598
Abdeckplatte, lichtgrau, 19 mm stark, mit Melaminharzbeschichtung, allseitig mit stoßfestem Kunststoffumleimer Cover plate, light grey, 19 mm thick, with melamin resin coating with shockproof synthetic edging	34.02.1593
Gehäuse-Sockel, Höhe 100 mm / Housing base, Height 100 mm	00.02.1594
Feinriefenmatte / Fine grooved mat	35.02.1590

### Pendeltüre / One wing swing door



Artikel / Product	Best.-Nr. / Ord.-no.
Klappdeckel, 718 mm breit, mit Winkelauflage, inklusive Handgriff Hinged cover, 718 mm wide, with support handle	00.02.1686
Pendeltüre einflügelig schwenkbar um 180° einschl. Pendeltürbänder, Befestigung seitlich am Schrank, lichte Breite 725 mm, Höhe 960 mm Swing door one leaf, opens by 180° incl. hinges for connection to the side of the cabinet, inside width 725 mm, height 960 mm	00.02.1680

# Schubladenschränke | Breite / Width 1434 x Tiefe / Depth 728 mm

## Drawer cabinets | Produktmerkmale / Product characteristics

### Merkmale / Characteristics



### Schrankgehäusehöhen / Nutzhöhen für den Einbau von Schubladen

#### Cabinet housing heights / Effective heights for the assembly of drawers

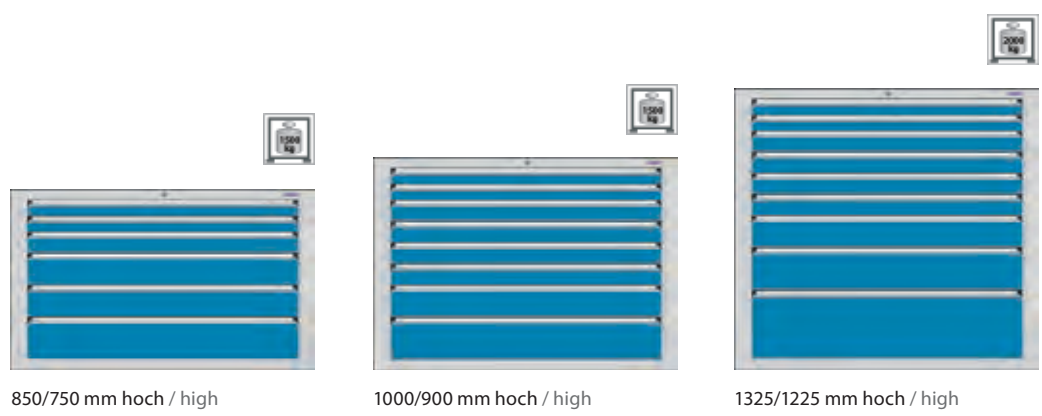

850/750 mm hoch / high

1000/900 mm hoch / high

1325/1225 mm hoch / high

### Nutzmaße der Schubladen / Effective size of drawers

Blendenhöhe der Schubladen (mm) Drawer face height (mm)	Nutzhöhe der Schubladen (mm) Drawer effective height (mm)	Nutzfläche (Breite x Tiefe mm) Effective space (Width x Depth mm)
50	35	1326 x 612
75	60	1326 x 612
100	85	1326 x 612
125	110	1326 x 612
150	135	1326 x 612
175	160	1326 x 612
200	185	1326 x 612
250	235	1326 x 612
300	285	1326 x 612

Nutzfläche im 17 mm Raster  
Effective space in 17 mm grid

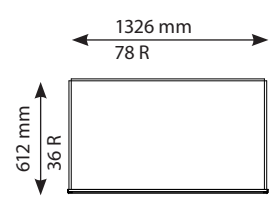

Raster (17 mm je Rastereinheit) erleichtern es Ihnen, die passenden Lagerkästen, Schlitzwand-sätze oder Muldensätze für die Schubladengröße zusammen zu stellen.

Grids (17 mm per grid unit) make it easier for you to arrange the matching storage boxes, slotted panel sets or trough sets for your drawer size.

Die Summe der Schubladenblendenhöhen muss der Nutzhöhe des Schrankgehäuses entsprechen.  
Beispiel: 9 x Blendenhöhe 100 mm = Nutzhöhe 900 mm  
The sum of all drawer face heights must be equal to the useable front height of the cabinet housing.  
Example: 9 x face height 100 mm = Effective height 900 mm

# Schubladenschränke | Breite / Width 1434 x Tiefe / Depth 728 mm

## Drawer cabinets | Bestellbeispiele / Order examples

Höhe / Height 850mm (Nutzhöhe / Eff. height 750 mm)

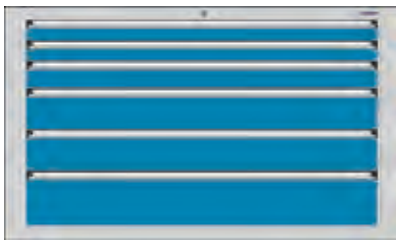

75  
75  
100  
150  
150  
200

6x

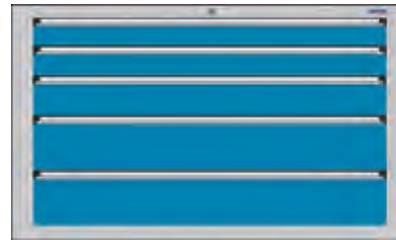

100  
100  
150  
200  
200

5x

Auszug/Pull out	Best.-Nr./Ord. no.
Vollauszug / Full pull-out	00.02.7642

Auszug/Pull out	Best.-Nr./Ord. no.
Vollauszug / Full pull-out	00.02.7640

Höhe / Height 1000 mm (Nutzhöhe / Eff. height 900 mm)



75  
75  
100  
100  
100  
100  
150  
200

8x

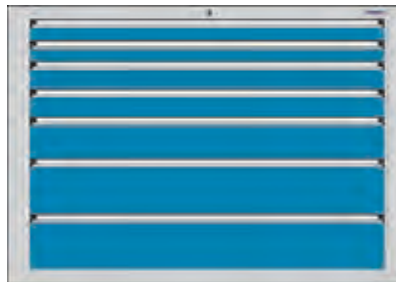

75  
75  
100  
100  
150  
200  
200

7x

Auszug/Pull out	Best.-Nr./Ord. no.
Vollauszug / Full pull-out	00.02.7591

Auszug/Pull out	Best.-Nr./Ord. no.
Vollauszug / Full pull-out	00.02.7646

Variante mit Schiebetüre / Variant with sliding door

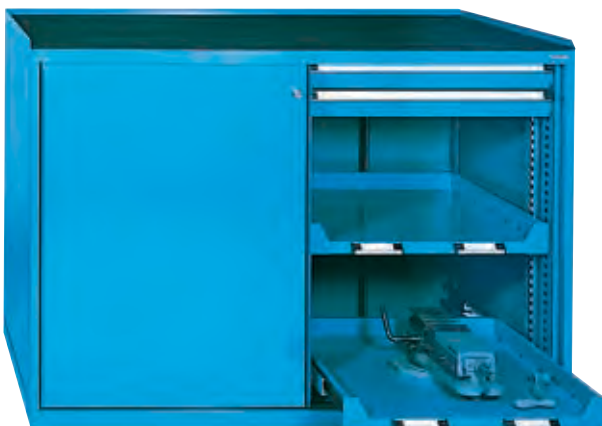

- Rechts und links jeweils 2 Schubladen Teilauszug, 75 mm  
2 Auszugböden Vollauszug
- Wahlweise mit Abrollrand und Feinriefenmatte
- Mit Schiebetüren und Schubladen-Ausziehsperre
- To the right and left 2 part pull-out drawers each 75 mm, 2 full pull-out shelf panels
- optional 3-sided roller tray and fine grooved mat
- With sliding doors and drawer pull-out interlock

	Best.-Nr./Ord.-no.
mit Abrollrand und Feinriefenmatte, 1030 mm hoch with roller tray and corrugated rubber mat, 1030 mm high	00.02.1904
ohne Abrollrand und Feinriefenmatte, 1000 mm hoch without roller tray and corrugated rubber mat, 1000 mm high	00.02.1900

**Schubladerschränke** | Breite / Width 1434 x Tiefe / Depth 728 mm

Drawer cabinets

Zubehör / Accessories

**Abrollrand / 3-sided roller tray**

- 3-seitig aufgekantetes Stahlblech, gefalzt
- Vernietet
- 3-sided roller tray, folded steel sheet
- Riveted

Breite / Width x Tiefe / Depth x Höhe / Height (mm)	Best.-Nr. / Ord.-no.
1434 x 728 x 30	00.02.7521

**Abdeckplatten / Cover plates**

- Lichtgraue Melaminharzbeschichtung
- Allseitig mit stoßfestem Kunststoffumleimer
- Verschraubbar
- Light-grey melamin resin coating
- All side with shockproof synthetic edging
- Can be screwed in

Breite / Width x Tiefe / Depth x Höhe / Height (mm)	Best.-Nr. / Ord.-no.
1434 x 728 x 19	00.02.7516

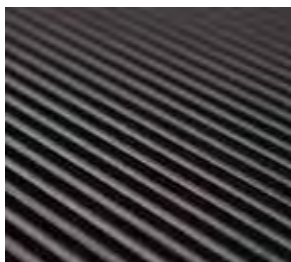
**Feinriefenmatte / Fine grooved mat**

- Qualität SBR
- Schwarz
- Auch als separate Auflage nutzbar
- Quality SBR
- Black
- Can be used separately

Breite / Width x Tiefe / Depth x Höhe / Height (mm)	Best.-Nr. / Ord.-no.
1431 x 727 x 3	35.02.7517

**Gehäuse-Sockel / Housing base**

- Gehäusesockel als Höhenausgleich, Höhe: 50 mm oder 100 mm, Tiefe 728 mm
- Housing base to balance height, height: 50 mm oder 100 mm, depth 728 mm

Sockel Base	Höhe (mm) Height (mm)	Breite (mm) Width (mm)	Best.-Nr. Ord.-no.
Gehäuse-Sockel Housing base	50	1434	00.02.7550
Gehäuse-Sockel Housing base	100	1434	00.02.7519

**2-Weg Hubwagensockel / 2-way lift base**

- 2-Weg Hubwagensockel, Tiefe 728 mm, mit 2 abnehmbaren Blenden
- 2-way lift base, depth 728 mm, with 2 detachable panels

Sockel Base	Höhe (mm) Height (mm)	Breite (mm) Width (mm)	Best.-Nr. Ord.-no.
2-Weg-Hubwagensockel 2-way lift base	100	1434	00.02.7520

# Schubladenschränke

Drawer cabinets

Breite / Width 1434 x Tiefe / Depth 728 mm

Schubladeneinteilungssätze / Drawer partition sets

## Schlitzwandsätze / Slotted panel sets

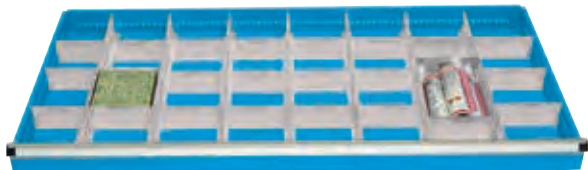

- 7 Schlitzwände 610 mm 36 R
- 3 Trennwände 133 mm 8 R
- 21 Trennwände 167 mm 10 R
- 7 slotted panels 610 mm 36 R
- 3 dividers 133 mm 8 R
- 21 dividers 167 mm 10 R

Blendenhöhen / Face heights	Best.-Nr. / Ord.-no.
75 mm	00.02.7652
100, 125 mm	00.02.7653
150, 175 mm	00.02.7654
200, 250 mm	00.02.7404



- 8 Schlitzwände 610 mm 36 R
- 24 Trennwände 116 mm 7 R
- 6 Trennwände 201 mm 12 R
- 8 slotted panels 610 mm 36 R
- 24 dividers 116 mm 7 R
- 6 dividers 201 mm 12 R

Blendenhöhen / Face heights	Best.-Nr. / Ord.-no.
75 mm	00.02.7657
100, 125 mm	00.02.7658
150, 175 mm	00.02.7659

## Schlitzwandsätze / Slotted panel sets



- 4 Schlitzwände 610 mm 36 R
- 2 Trennwände 201 mm 12 R
- 6 Trennwände 269 mm 16 R
- 2 Trennwände 303 mm 18 R
- 4 slotted panels 610 mm 36 R
- 2 dividers 201 mm 12 R
- 6 dividers 269 mm 16 R
- 2 dividers 303 mm 18 R

Blendenhöhen / Face heights	Best.-Nr. / Ord.-no.
75 mm	00.02.7673
100, 125 mm	00.02.7674
150, 175 mm	00.02.7675
200, 250 mm	00.02.7676



- 5 Schlitzwände 610 mm 36 R
- 9 Trennwände 167 mm 10 R
- 3 Trennwände 201 mm 12 R
- 6 Trennwände 303 mm 18 R
- 5 slotted panels 610 mm 36 R
- 9 dividers 167 mm 10 R
- 3 dividers 201 mm 12 R
- 6 dividers 303 mm 18 R

Blendenhöhen / Face heights	Best.-Nr. / Ord.-no.
75 mm	00.02.7677
100, 125 mm	00.02.7678
150, 175 mm	00.02.7679
200, 250 mm	00.02.7680

## Schlitzwandsätze / Slotted panel sets



- 6 Schlitzwände 610 mm 36 R
- 16 Trennwände 99 mm 6 R
- 12 Trennwände 303 mm 18 R
- 6 slotted panels 610 mm 36 R
- 16 dividers 99 mm 6 R
- 12 dividers 303 mm 18 R

Blendenhöhen / Face heights	Best.-Nr. / Ord.-no.
75 mm	00.02.7666
100, 125 mm	00.02.7667
150, 175 mm	00.02.7668

## Zellkautschuk-Einlage / Foam rubber insert

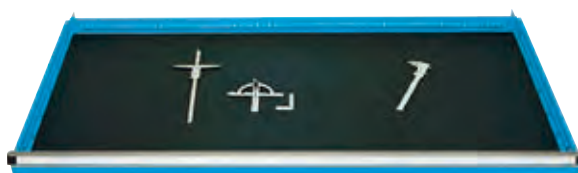

- Zellkautschuk-Einlage für die Lagerung empfindlicher Messzeuge und Lehren
- Qualität EPDM, schwarz
- Breite 1324 mm x Tiefe 610 mm x Dicke 3 mm
- Passend für alle Blendenhöhen
- Foam rubber insert for storing delicate measuring tools and gauges
- Quality EPDM, black
- Width 1324 mm x Depth 610 mm x Thickness 3 mm
- Fits all face heights

Best.-Nr. / Ord.-no.
27.02.7670

## Schubladenschränke | Breite / Width 1434 x Tiefe / Depth 728 mm

### Drawer cabinets | Schubladeneinteilungssätze / Drawer partition sets

#### Einsatzkastensätze / Insert boxes sets



- 32 Einsatzkästen 75 x 75 x 46 mm
- 32 insert boxes 75 x 75 x 46 mm
- 32 Einsatzkästen 150 x 75 x 46 mm
- 32 insert boxes 150 x 75 x 46 mm
- 8 Einsatzkästen 150 x 150 x 46 mm
- 8 insert boxes 150 x 150 x 46 mm
- 2 Schlitzwände 610 mm 36 R
- 2 slotted panels 610 mm 36 R
- 4 Trennwände 99 mm 6 R
- 4 dividers 99 mm 6 R

Blendenhöhe Face height	Höhe Schlitz- und Trennwände Height of slotted panels and dividers	Best.-Nr. Ord.-no.
75 mm	50 mm	00.02.7682



- 32 Einsatzkästen 150 x 75 x 46/71 mm
- 32 insert boxes 150 x 75 x 46/71 mm
- 16 Einsatzkästen 150 x 150 x 46/71 mm
- 16 insert boxes 150 x 150 x 46/71 mm
- 2 Schlitzwände 610 mm 36 R
- 2 slotted panels 610 mm 36 R
- 4 Trennwände 99 mm 6 R
- 4 dividers 99 mm 6 R

Blendenhöhen Face heights	Höhe Schlitz- und Trennwände Height of slotted panels and dividers	Best.-Nr. Ord.-no.
75 mm	50 mm	00.02.7687
100 mm	75 mm	00.02.7688

#### Muldensätze / Trough sets



- 32 Mulden 4-teilig
- 32 troughs 4-teilig
- 100 Steckwände 36 mm
- 100 trough inserts 36 mm
- 2 Schlitzwände 610 mm 36 R
- 2 slotted panels 610 mm 36 R
- 3 Trennwände 99 mm 6 R
- 3 dividers 99 mm 6 R

Blendenhöhe / Face height	Best.-Nr. / Ord.-no.
75 mm	00.02.7671



- 32 Mulden 3-teilig
- 32 troughs 3-part
- 80 Steckwände 48 mm
- 80 trough inserts 48 mm
- 2 Schlitzwände 610 mm 36 R einseitig
- 2 slotted panels 610 mm 36 R one sided
- 3 Trennwände 99 mm 6 R
- 3 dividers 99 mm 6 R

Blendenhöhen / Face heights	Best.-Nr. / Ord.-no.
75, 100 mm	00.02.7672

#### AQRADO® - Modulares Ordnungssystem / Modular filing system



- AQRADO®-System bestehend aus: 18 Universalboxen, 3 Ausgleichsboxen und Steckschlüsselbox, Klebepad, AQRADO®-Platte
- Breite 1320 mm x Tiefe 600 mm x Höhe 52 mm
- AQRADO® system consisting of: 18 all-purpose boxes, 3 balancing boxes and wrench box, sticky pad, AQRADO® board
- Width 1320 mm x Depth 600 mm x Height 52 mm

Blendenhöhe / Face height	Best.-Nr. / Ord.-no.
Ab / From 75 mm	45.02.0070



- AQRADO®-System bestehend aus: 13 Universalboxen, Schraubendreherbox, Klebepad, AQRADO®-Platte
- Breite 1320 mm x Tiefe 600 mm x Höhe 52 mm
- AQRADO® system consisting of: 13 all-purpose boxes, screw driver box, sticky pad, AQRADO® board
- Width 1320 mm x Depth 600 mm x Height 52 mm

Blendenhöhe / Face height	Best.-Nr. / Ord.-no.
Ab / From 75 mm	45.02.0071





RS  
440RS  
565RS  
576RS  
717RS  
1000RS  
1024RS  
1196RS  
1434Schubl-  
regal

## Schubladenregale

Shelf units with drawers

## Produktmerkmale

Product characteristics



- LOKOMA-Schubladenregale ermöglichen eine vielseitige und komprimierte Lagerung von Kleinteilen, Materialien und Werkzeugen bei bestmöglicher Raumausnutzung und schneller Zugriffsmöglichkeit.
- Mit diesem Regalsystem lassen sich Lagereinrichtungen bis zu einer Höhe von 2500 mm und in fünf kombinierbaren Breiten aufbauen.
- Durch die individuelle Bestückung mit Schubladen, Verstell- und Auszugböden ergeben sich fast unbegrenzte Möglichkeiten den Nutzraum optimal auf die zu lagernden Teile abzustimmen.
- Kleinteile werden in Schubladen der Schrankgehäusebreiten 565, 718, 1024, 1196 und 1434 mm, die in das Regal integriert sind, staubgeschützt und übersichtlich gelagert. Für größere Teile und Verpackungseinheiten gibt es Verstellböden. Für schwere Teile stehen Auszugböden zur Verfügung.
- Für die Unterteilung der Schubladen werden die gleichen Unterteilungssätze und Materialien wie bei den Schubladenschränken verwendet.
- Der Zugriff zu den oberen Schubladen und Fächern wird durch den Einsatz unserer Stufenstehtreiter mit Federrollen sicher und einfach vorgenommen.
- LOKOMA-shelf units with drawers are based on an ingenious space-saving storage concept which permits hardware, materials and tools to be stored with a maximum of versatility and accessibility.
- This shelving system allows storage installations to be erected up to a height of 2500 mm and in five combinable widths.
- The vast range of available drawers, variable shelves and pull-out shelves opens up almost unlimited possibilities of optimally adapting the available space to the parts to be stored.
- The RS 565, 717, RS 1024, RS 1196 an RS 1434 drawers integrated into the shelf unit provide dust-protected and orderly storage of small components and hardware, where as larger parts and packing cases are stored on variable shelves. Pull-out shelves are available for heavy parts.
- The partitioning sets for the drawers are identical to those used for the drawer cabinets.
- Quick and safe access to the uppermost drawers and shelves is guaranteed by our stage standing ladder with springing rollers.

# Schubladenregale

Shelf units with drawers

# Bestellbeispiele

Order Examples



**Begriffserklärung:** TA = Teilauszug, VA = Vollauszug  
**Explanation:** TA = Part pull-out, VA = Full pull-out

- Schubladenregal / Shelf unit with drawers  
2250 x 2000 x 711 mm (B x H x T) / (W x H x D)
- Grundfeld 36 R bestehend aus:
  - 2 Regalrahmen
  - 1 Kombiboden
  - 1 Zentralverschluss Teilhöhe
  - 1 Rückwand
  - 2 Verstellböden
  - 8 Schubladen
- Basic bay 36 R consisting of:
  - 2 shelf unit frames
  - 1 combi panel
  - 1 central locking device for partial sections
  - 1 rear panel
  - 2 variable shelf panels
  - 8 drawers
- 2 Anbaufelder 36 R bestehend aus je:
  - 1 Regalrahmen
  - 1 Kombiboden
  - 1 Zentralverschluss Teilhöhe
  - 1 Rückwand
  - 2 Verstellböden
  - 8 Schubladen
- 2 add-on bays 36 R each consisting of:
  - 1 shelf unit frame
  - 1 combi panel
  - 1 central locking device for partial sections
  - 1 rear panel
  - 2 variable shelf panels
  - 8 drawers

75 TA  
75 VA  
100 TA  
100 TA  
100 TA  
100 TA  
150 VA  
200 VA

	Best.-Nr. / Ord.-no.
Grundfeld / Basic bay	00.02.2065
Anbaufeld / Add-on bay	00.02.2066
Seitenwand / Side panel	00.02.1937



100  
200  
200  
400

75  
75  
100  
100  
100  
200  
250

Alle Schubladen mit Teilauszug  
All drawers with part pull-out

- Schubladenregal  
3166 x 2250 x 711 mm (B x H x T)
- Shelf unit with drawers  
3166 x 2250 x 711 mm (W x H x D)
- 1 Grundfeld 54 R und 2 Anbaufelder 54 R bestehend aus:
  - 4 Regalrahmen
  - 7 Kombiböden
  - 2 Zentralverschlüsse Teilhöhe
  - 3 Rückwände
  - 2 Seitenwände
  - 2 Zwischenseitenwände
  - 2 Türensätze 1250 mm hoch
  - 6 Verstellböden
  - 2 Auszugsböden
  - 11 Schubladen Teilauszug
- 1 basic bay 54 R und 2 add-on bays 54 R consisting of:
  - 4 shelf unit frames
  - 7 combi panels
  - 2 central locking device for partial sections
  - 3 rear panels
  - 2 side panels
  - 2 partitions
  - 2 door kits 1250 mm high
  - 6 variable shelf panels
  - 2 pull-out shelf panels
  - 11 drawers part pull-out

Best.-Nr. / Ord.-no.

00.02.2071



- Schubladenregal  
1122 x 2250 x 711 mm (B x H x T)
- Shelf unit with drawers  
1122 x 2250 x 711 mm (W x H x D)
- Grundfeld 54 R bestehend aus:
  - 2 Regalrahmen
  - 1 Rückwand
  - 2 Seitenwände
  - 3 Kombiböden
  - 2 Auszugsböden mit Vollauszug
  - 2 Verstellböden
- Add-on bay 54 R consisting of:
  - 1 shelf unit frame
  - 1 rear panel
  - 3 combi panels
  - 2 pull-out shelf panels with full pull-out
  - 2 variable shelf panels
- Schubladenregal  
1045 x 2250 x 711 mm (B x H x T)
- Shelf unit with drawers  
1045 x 2250 x 711 mm (W x H x D)
- Anbaufeld 54 R bestehend aus:
  - 1 Regalrahmen
  - 1 Rückwand
  - 3 Kombiböden
  - 2 Auszugsböden mit Vollauszug
  - 2 Verstellböden
- Basic bay 54 R consisting of:
  - 2 shelf unit frames
  - 1 rear panel
  - 2 side panels
  - 3 combi panels
  - 2 pull-out shelf panels with full pull-out
  - 2 variable shelf panels

	Best.-Nr. / Ord.-no.
Grundfeld / Basic bay	00.02.2072
Anbaufeld / Add-on bay	00.02.2073

## Schubladenregale | Bestellbeispiele

### Shelf units with drawers | Order Examples

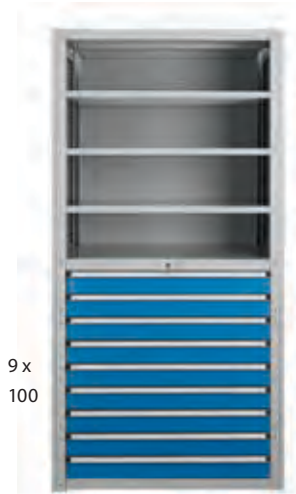

9 x  
100

- Schubladenregal 1122 x 2250 x 711 mm (B x H x T)
- Grundfeld 54 R bestehend aus:  
2 Regalrahmen  
1 Rückwand  
1 Kombiboden  
1 Teil-Zentralverschluss  
3 Verstellböden  
9 Schubladen mit Teilauszug  
2 Seitenwände
- Schubladenregal 1045 x 2250 x 711 mm (B x H x T)
- Anbaufeld 54 R bestehend aus:  
1 Regalrahmen  
1 Rückwand  
1 Kombiboden  
1 Teil-Zentralverschluss  
3 Verstellböden  
9 Schubladen mit Teilauszug
- Shelf unit with drawers 1122 x 2250 x 711 mm (W x H x D)
- Basic bay 54 R consisting of:  
2 shelf unit frames  
1 rear panel  
1 combi panel  
1 part-central locking  
3 variable shelf panels  
9 drawers with part pull-out  
2 side panels
- Shelf unit with drawers 1045 x 2250 x 711 mm (W x H x D)
- Add-on bay 54 R consisting of:  
1 shelf unit frame  
1 rear panel  
1 combi panel  
1 part-central locking  
3 variable shelf panels  
9 drawers with part pull-out

	Best.-Nr. / Ord.-no.
Grundfeld / Basic bay	00.02.2074
Anbaufeld / Add-on bay	00.02.2075

Alle Schubladen mit Teilauszug  
All drawers with part pull-out



75  
75  
100  
100  
200  
250

- Schubladenregal 1122 x 2250 x 711 mm (B x H x T)
- Grundfeld 54 R bestehend aus:  
2 Regalrahmen  
1 Rückwand  
2 Kombiböden  
2 Seitenwände  
1 Teil-Zentralverschluss  
2 Verstellböden  
7 Schubladen mit Teilauszug  
1 Türensatz 1250 mm hoch
- Schubladenregal 1045 x 2250 x 711 mm (B x H x T)
- Anbaufeld 54 R bestehend aus:  
1 Regalrahmen  
1 Rückwand  
2 Kombiböden  
1 Teil-Zentralverschluss  
2 Verstellböden  
7 Schubladen mit Teilauszug  
1 Türensatz 1250 mm hoch  
1 Zwischenseitenwand
- Shelf unit with drawers 1122 x 2250 x 711 mm (W x H x D)
- Basic bay 54 R consisting of:  
2 shelf unit frames  
1 rear panel  
2 combi panels  
2 Seitenwände  
1 part-central locking  
2 variable shelf panels  
7 drawers with part pull-out  
1 door kit 1250 mm high
- Shelf unit with drawers 1045 x 2250 x 711 mm (W x H x D)
- Add-on bay 54 R consisting of:  
1 shelf unit frame  
1 rear panel  
2 combi panels  
1 part-central locking  
2 variable shelf panels  
7 drawers with part pull-out  
1 door kit 1250 mm high  
1 partition

	Best.-Nr. / Ord.-no.
Grundfeld / Basic bay	00.02.2076
Anbaufeld / Add-on bay	00.02.2077

Alle Schubladen mit Teilauszug  
All drawers with part pull-out



100  
200  
200  
400

- Schubladenregal 1122 x 2250 x 711 mm (B x H x T)
- Grundfeld 54 R bestehend aus:  
2 Regalrahmen  
1 Rückwand  
2 Kombiböden  
1 Teil-Zentralverschluss  
2 Verstellböden  
4 Schubladen mit Teilauszug  
1 Türensatz 1250 mm hoch  
2 Seitenwände
- Schubladenregal 1045 x 2250 x 711 mm (B x H x T)
- Anbaufeld 54 R bestehend aus:  
1 Regalrahmen  
1 Rückwand  
2 Kombiböden  
1 Teil-Zentralverschluss  
2 Verstellböden  
4 Schubladen mit Teilauszug  
1 Türensatz 1250 mm hoch  
1 Zwischenseitenwand
- Shelf unit with drawers 1122 x 2250 x 711 mm (W x H x D)
- Basic bay 54 R consisting of:  
2 shelf unit frames  
1 rear panel  
2 combi panels  
1 part-central locking  
2 variable shelf panels  
4 drawers with part pull-out  
1 door kit 1250 mm high  
2 side panels
- Shelf unit with drawers 1045 x 2250 x 711 mm (W x H x D)
- Add-on bay 54 R consisting of:  
1 shelf unit frame  
1 rear panel  
2 combi panels  
1 part-central locking  
2 variable shelf panels  
4 drawers with part pull-out  
1 door kit 1250 mm high  
1 partition

	Best.-Nr. / Ord.-no.
Grundfeld / Basic bay	00.02.2078
Anbaufeld / Add-on bay	00.02.2079

Alle Schubladen mit Teilauszug  
All drawers with part pull-out

## Schubladenregalsysteme

Shelving systems with drawers

## Bestellbeispiele

Order examples



WS 8 / 600



### ■ Abmessungen

Breite: 816 mm  
Höhe: 1.000 mm + Display  
Tiefe: 711 mm

### ■ Lagerkapazität

Schubladen: 8 Stück  
Traglast per: 200 kg

- Anzahl und Höhe der Schubladen sowie die Positionenanzahl sind variabel.

### ■ Systemdetails

- Einzelverriegelung der Schubladen und der Fächer (optional)
- Optische Anzeige des Lagerplatzes
- Facheinteilung variabel
- Kontrollleuchte für Schubladenfreigabe
- Integrierter Hubwagensockel

### ■ Varianten

Schubladenanzahl/und -höhen sind konfigurierbar, der Einsatz von Klappen ist möglich.

**Alle Systeme sind als Master- oder Slavesystem erhältlich.**

### ■ Dimensions

Width: 816 mm  
Height: 1.000 mm + display  
Depth: 711 mm

### ■ Storage capacity

Drawers: 8  
Load capacity per unit: 200 kg

- The number and height of drawers and the number of positions are variable.

### ■ System details

- Individually lockable drawers and compartments (optional)
- Visual display of storage location
- Variable compartment partitioning
- Indicator light for released drawers
- integrated base for lift truck forks

### ■ Variants

The number of drawers and drawer heights are configurable; flaps can be configured.

**All systems are available as master or slave systems.**





## Schubladenregalsysteme

Shelving systems with drawers

## Bestellbeispiele

Order examples

WS 11 / 600-F



- Breite: 816 mm
- Höhe: 1.500 mm
- Tiefe: 711 mm
- Schubladen: 12
- Traglast per: 200 kg
- Width: 816 mm
- Height: 1.500 mm
- Depth: 711 mm
- Drawers: 12
- Capacity per: 200 kg

WS 30 / 300-F



- Breite: 918 mm
- Höhe: 1.500 mm
- Tiefe: 711 mm
- Schubladen: 30
- Traglast per: 200 kg
- Width: 918 mm
- Height: 1.500 mm
- Depth: 711 mm
- Drawers: 30
- Capacity per: 200 kg

WS 12 / 600



- Breite: 816 mm
- Höhe: 2.000 mm
- Tiefe: 711 mm
- Schubladen: 12
- Traglast per: 200 kg
- Width: 816 mm
- Height: 2.000 mm
- Depth: 711 mm
- Drawers: 12
- Capacity per: 200 kg

WS 30 / 300



- Breite: 918 mm
- Höhe: 2.000 mm
- Tiefe: 711 mm
- Schubladen: 30
- Traglast per: 200 kg
- Width: 918 mm
- Height: 2.000 mm
- Depth: 711 mm
- Drawers: 30
- Capacity per: 200 kg

WS 12 / 1000-F



- Breite: 1.294 mm
- Höhe: 1.500 mm
- Tiefe: 711 mm
- Schubladen: 12
- Traglast per: 200 kg
- Width: 1.294 mm
- Height: 1.500 mm
- Depth: 711 mm
- Drawers: 12
- Capacity per: 200 kg

WS 12 / 1000



- Breite: 1.294 mm
- Höhe: 2.000 mm
- Tiefe: 711 mm
- Schubladen: 12
- Traglast per: 200 kg
- Width: 1.294 mm
- Height: 2.000 mm
- Depth: 711 mm
- Drawers: 12
- Capacity per: 200 kg

WS 36 / 300



- Breite: 1.327 mm
- Höhe: 2.000 mm
- Tiefe: 711 mm
- Schubladen: 36
- Traglast per: 200 kg
- Width: 1.327 mm
- Height: 2.000 mm
- Depth: 711 mm
- Drawers: 36
- Capacity per: 200 kg

## Schubladenregalsysteme

Shelving systems with drawers

## Bestellbeispiele

Order examples



WS 30 / 300



### ■ Abmessungen

Breite: 1.327 mm  
Höhe: 1.000 mm + Display  
Tiefe: 711 mm

### ■ Lagerkapazität

Schubladen: 30 Stück  
Traglast per: 200 kg

- Anzahl und Höhe der Schubladen sowie die Positionenanzahl sind variabel.

### ■ Systemdetails

- Einzelverriegelung der Schubladen und Fächer
- Optische Anzeige des Lagerplatzes
- Facheinteilung variabel
- Kontrollleuchte für Schubladenfreigabe
- Integrierter Hubwagensockel

**Alle Systeme sind als Master- oder Slavesystem erhältlich.**

### ■ Dimensions

Width: 1.327 mm  
Height: 1.000 mm + display  
Depth: 711 mm

### ■ Storage capacity

Drawers: 30  
Load capacity per unit: 200 kg

- The number and height of drawers and the number of positions are variable.

### ■ System details

- Individually lockable drawers and compartments (optional)
- Visual display of storage location
- Variable compartment partitioning
- Indicator light for released drawers
- integrated base for lift truck forks

**All systems are available as master or slave systems.**





## Schubladenregalsysteme

Shelving systems with drawers

## Bestellbeispiele

Order examples

WS 24 / 150-F



- Breite: 868 mm
- Höhe: 1.500 mm
- Tiefe: 711 mm
- Schubladen: 24
- Traglast per: 200 kg
- Width: 868 mm
- Height: 1.500 mm
- Depth: 711 mm
- Drawers: 24
- Capacity per: 200 kg

WS 60 / 150-F



- Breite: 1.124 mm
- Höhe: 1.500 mm
- Tiefe: 711 mm
- Schubladen: 60
- Traglast per: 200 kg
- Width: 1.500 mm
- Height: 1.450 mm
- Depth: 711 mm
- Drawers: 60
- Capacity per: 200 kg

WS 45 / 150



- Breite: 868 mm
- Höhe: 2.000 mm
- Tiefe: 711 mm
- Schubladen: 45
- Traglast per: 200 kg
- Width: 868 mm
- Height: 2.000 mm
- Depth: 711 mm
- Drawers: 45
- Capacity per: 200 kg





# Schubladenregalsysteme

Shelving systems with drawers

# Bestellbeispiele

Order examples



WS 75 / 150



## ■ Abmessungen

Breite: 1.380 mm  
Höhe: 2.000 mm  
Tiefe: 711 mm

## ■ Lagerkapazität

Schubladen: 75 Stück  
245 mm breit  
Traglast per: 200 kg

■ Anzahl und Höhe der Schubladen sowie die Positionenanzahl sind variabel.

## ■ Systemdetails

- Einzelverriegelung der Schubladen und der Einzelfächer (optional)
- Optische Anzeige des Lagerplatzes
- Facheinteilung variabel
- Kontrollleuchte für Schubladenfreigabe
- Integrierter Hubwagensockel

## ■ Alle Systeme sind als Master- oder Slavesystem erhältlich.

## ■ Dimensions

Width: 1.380 mm  
Height: 2.000 mm  
Depth: 711 mm

## ■ Storage capacity

Drawers: 75  
245 mm wide  
Capacity per: 200 kg

■ The number and height of drawers and the number of positions are variable.

## ■ System details

- Individually lockable drawers and compartments (optional)
- Visual display of storage location
- Variable compartment partitioning
- Indicator light for released drawers
- integrated base for lift truck forks

**All systems are available as master or slave systems.**



FS 4



- Breite: 918 mm
- Höhe: 1.000 mm
- Tiefe: 711 mm
- Fächer: 4
- Fachformat: 400 x 400 mm

■ Fachanzahl, Höhen und Breiten konfigurierbar.  
 Perfekt für Elektrogeräte  
 Vorteil: Rückverfolgbarkeit einzelner Werkzeuge.

- Width: 918 mm
- Height: 1.000 mm
- Depth: 711 mm
- Compartments: 4
- Comp. format: 400 x 400 mm

■ Configurable compartment number, heights and widths.  
 Perfect for electric appliances  
 Advantage: Traceability of individual tools.

VAS 2 / 120



- Breite: 816 mm
- Höhe: 1.000 mm
- Tiefe: 711 mm
- Fachformat: z.B. SK40, HSK

■ Fachanzahl, Höhen und Breiten konfigurierbar.  
 Verschiedene Werkzeug-einsätze verfügbar.

- Width: 816 mm
- Height: 1.000 mm
- Depth: 711 mm
- Comp. format: e. G. SK40, HSK

■ Configurable compartment number, heights and widths.  
 Different tool inserts available.

### Rastertechnik für 150 mm und 300 mm breite Schubladen / Grid design for 150 mm and 300 mm wide drawers

- Ein flexibles System zur Einzelausgabe gleicher (artgleicher) Artikel. Das Rastermaß kann gemäß Ihrer Anforderungen bequem über die eingesetzten Trennteiler konfiguriert und jederzeit wieder geändert werden. Unser System gibt so jeweils nur eine Verpackungseinheit nach der anderen frei.
- A flexible system for dispensing individual articles (of the same type). The grid dimension can be configured conveniently as per your requirements using the separating inserts and can be changed at any time. Our system ensures that only one packaging unit is released at a time.



Stufe 1 / Step 1



Stufe 2 / Step 2



Stufe 3 / Step 3

### Klappentechnik – Standardgrößen für 600 mm breite Schubladen / Flap design – Standard sizes for 600 mm wide drawers

- Standardisierte Klappengrößen die eine gesicherte Einzelentnahme und Rückverfolgbarkeit gewährleisten. Das Klappensystem ist modular aufgebaut, so dass einzelne Schubladen bestückt werden können.
- Standardized flap sizes ensure traceability and safe retrieval of individual articles. The flap system has a modular design, allowing individual drawers to be loaded.



40 St. á 66,5 x 77 mm (BxT)



32 St. á 66,5 x 107 mm (BxT)



24 St. á 66,5 x 150 mm (BxT)

### Einteilungsmaterial für maximale Flexibilität / Partitioning material for maximum flexibility

- Variables Einteilungsmaterial steht für die optimale Nutzung der verfügbaren Schubladenfläche. Neben hochwertigen Kunststoffeinteilungen bieten wir ein passgenaues Trennblechsystem sowie individuelle Lösungen, z. B. passgenaue Hartschaumeinlagen.
- Variable partitioning material allows for optimum utilization of available drawer space. In addition to high-quality plastic partitionings, we offer an accurately fitting separating plate system and individual solutions, e.g. precisely fitting rigid foam inserts.



Kleine Kunststoffeinteilung  
Small plastic partitioning



Größere Kunststoffeinteilung  
Larger plastic partitioning



Variable Steckblecheinteilung  
Variable insert plate partitioning

# Schubladenregalsysteme | Optionen

## Shelving systems with drawers | Options

### Zugangskontrolle: RFID, Barcode, Fingerprint / Access control: RFID, bar code, fingerprint

- Das RFID Lesegerät lässt sich optimal mit vorhandenen Karten (z.B. Zeiterfassung) und Transpondern vereinen. Mit unserem Fingerprintleser bieten wir eine weitere bequeme und sichere Lösung zur Authentifizierung am System. Der Barcodeleser ist als 1D- und 2D Variante verfügbar. Neben der einfachen Artikelsuche können die Geräte auch für weitere Buchungen und zur Authentifizierung genutzt werden.
- The RFID reader can be combined optimally with existing cards (e.g. for time registration) and transponders. Our fingerprint readers offer another convenient and safe solution for system authentication. The bar code reader is available in 1D and 2D variants. In addition to the simple article search, the devices can also be used for additional bookings and for authentication.



RFiD / RFiD



Barcode / bar code



Fingerprint / fingerprint

### Schubladensysteme für unterschiedliche Größen, Mengen, Inhalte / Drawer systems for different sizes, quantities, contents

- Alle Schubladensysteme können einem Rastermaß entsprechend mit unterschiedlichen Schubladenhöhen konfiguriert werden. Die Schubladenhöhen reichen dabei von 75mm bis 300mm.
- All drawer systems can be configured based on an appropriate grid dimension and with different drawer heights. Drawer heights from 75 mm to 300 mm are available.



### Kombinationsmöglichkeiten – Spirale, Förderband, Klappe in Reihe und Glied

#### Combination options – Spirals, conveyor belts and flaps in tidy rows

- Neben Kombinationsmöglichkeiten aus den verschiedenen Systemen können auch einzelne Varianten im Baukasten kombiniert werden. So lassen sich Schubladensysteme mit Spiraltechnik für Ihre Schnellläufer kombinieren oder aber einzelne Schubladen mit Raster- oder Klappentechnik versehen. Gerne realisieren wir Ihre Anforderungen an die optimale Artikellagerung.
- In addition to options combining the different systems, it is also possible to combine individual variants on a modular basis. This allows you to combine drawer systems with spiral technology for your fast moving items, or equip individual drawers with grid or flap technologies. We look forward to realizing your requirements for optimum article storage.



Spirale / Spiral

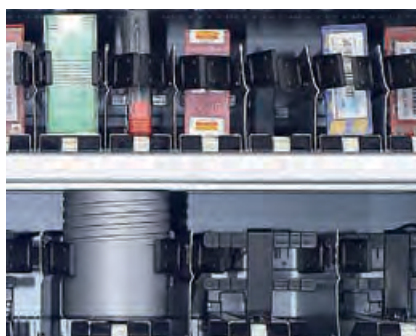

Förderband / Conveyor belt



Klappe / Flap

